



## 2. RECOGNITION OF ACOUSTIC SIGNALS

Recognition of signals is a process with a number of aspects [7, 8]. From the different acoustic stimuli from the surrounding area, the signal must be discovered as a relevant acoustic change: the signal is recognised, i.e., it is heard and it is distinguished as such from other sound events and it is identified as a signal. In this study one area of prime interest is recognition capacity, i.e., the hearing and identification performance of subjects under certain acoustic conditions. A measure of the audibility of signals is the masked threshold. The masked threshold is the sound level of the signal at which this signal can also just be heard against the noise [9]; an equivalent quantity—clearer defined—is the masked threshold at which 50% of the signals presented can be heard. The masked threshold used in this study is the signal-to-noise ratio, at which 50% of a presented signal can be heard or identified. Identification of signals includes the ability of the subjects to correctly assign the learnt meaning of an individual signal.

If HP are worn in a quiet environment the attenuation of HP may push ambient signals, especially the high-frequency portions of such signals, to below the subjects' hearing threshold to the point at which they become inaudible. For subjects with normal hearing this only applies with regard to relatively quiet ambient signals, which may, however, be important for orientation purposes. For hearing-impaired subjects, who may suffer hearing loss of between 30 and 60 dB or more, the hearing threshold is raised by HP to the point at which even loud signals may no longer be audible [3, 4, 10, 11, 12].

Sandstede [13], who examined signals and machine noise in the paper-processing industry, believed that the application of HP (cotton wool) would not increase the accident risk provided they were properly selected.

In an extensive study Levin [14] tested the perception of acoustic signals when HP were worn. The noise used was from mining machines. Masked thresholds for sinus tones were measured with and without HP. The masked thresholds when HP were worn exceeded those without HP

up to 250 Hz. In the range which is of interest for acoustic signals, namely from 500 Hz up, the masked threshold with and without HP is approximately equal; partly the signals can be heard better with than without HP.

Jungsbluth and Meisel [15] contradicted the alternative, namely, that HP can either only prevent an accident or only prevent hearing impairment. They conducted a field test with 26 subjects during track tamping work with motorised tamping at a sound level of  $L_{NA} = 97\text{--}99$  dB, where tyfon signals were sounded. At least it can be said for this pilot study that signal recognition did not always deteriorate when HP were worn.

In a study of the Deutsche Reichsbahn (East German Railways) Lessing and Sauer [12] presented normally hearing and hearing-impaired subjects with signals (siren, horn, stop shouts) with simultaneous noise from a tractor (frequency distribution of  $-3$  dB/octave). Hearing performance was determined with these signals for 26 different subjects, some of whom wore muffs, whereas others had uncovered ears. Normally hearing and almost-normally hearing subjects showed an improvement, hearing-impaired persons showed deterioration in the masked threshold.

Abel et al. [16] studied the perception of signals (1 and 3 kHz) by groups of normally hearing and hearing-impaired persons ( $L_{HLT,1k} = 35$  dB,  $L_{HLT,3k} = 61$  dB) (HLT—hearing loss tones) with (P) and without (W) plugs. At noise levels of  $L_{NA} = 80$  to 84 dB there were slight improvements for persons with normal hearing when plugs were worn ( $-5$  to 1.5 dB), and for the hearing-impaired there was an increase in the masked threshold (0 to 33 dB).

In a series of investigations Wilkins and Martin studied the question of how the recognition of warning sounds was affected by HP. On the one hand, they assumed that reduced loudness restricted the character of the warning and hence the effectiveness of such warning sounds declined [17, 18]. The results of the experiments also indicated that perception was reduced when HP were used, especially in the case of rare and unexpected signals which had to be recognised among other signals and noise [5, 19].

Identifying acoustic patterns may be impaired by muffs [20]. In manufacturing processes a change

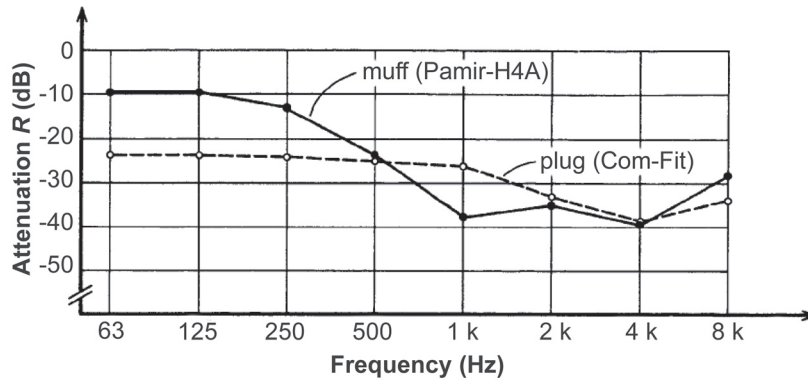

Figure 1. Attenuation  $R$  (dB) of hearing protectors (plug, muff).

in the noise spectrum is often taken to mean a certain operating state in the machine or working process. Christ [21] analysed the change in noise in a drop forge, which indicated to the employees that a die had become detached. To ensure that it is still possible to identify these small changes in noise (about  $DL_t = 5$  dB from 2 kHz) when HP are being worn, the HP selected must be such that as little as possible is falsified.

The results given by the literature discussed in this section are contradictory. Therefore the study had to be designed in a way that the influence of hearing protection, noise, signals, hearing loss and noise level on signal recognition could be observed. The investigation was carried out in a laboratory under near-real conditions (track laying work). The frequency distributions of the mentioned parameters were taken into account. On the basis of the results, an attempt was made to draw general conclusions concerning the wearing of HP.

### 3. AIM OF THE STUDY

Psycho-acoustic tests were used to examine the influence of HP with respect to the recognition of tyfon signals with the simultaneous presence of interfering noise. Subjects—wearing appropriate HP—were presented with typical noise from track work and with tyfon signals through loudspeakers. In addition it was intended to examine the influence of the sound level as well as of the frequency spectrum of the noise on signal recognition. Since people with noise-induced hearing impairment may also be employed on railway tracks, it was also intended to include the question of how far

signal recognition was affected by the subjects' hearing loss.

Since the frequency response of sound attenuation may influence the perception of signals, an ear plug (Com-Fit, North Safety Products, USA) and ear muffs (Pamir-H4A, Germany) were included in the study (Figure 1). In addition ear muffs with selective band filters were referred to in the study [22]. The muff used (ear muff B) had mechanical band filters installed with the overtones of a tyfon signal at the frequencies of 0.67/0.9/1.13/1.35 kHz. The attenuation of those muffs deteriorated at those frequencies by 10–20 dB as against the usual attenuation.

Two parameters were used in this study to describe signal recognition: (a) the hearing capacity of individuals (hearing performance), i.e., the number of signals heard and their masked threshold; (b) the extent to which individuals correctly identified the three different tyfon signals.

## 4. PROCEDURE OF THE PSYCHO-ACOUSTIC EXPERIMENTS

### 4.1. Selection of Signals and Noise

The four kinds of noise used in the test were typical for the workplace of track construction workers and covered different spectra (Figure 2). They were N1 (track tamping machine), N2 (corrugated grinding machine), N3 (bed cleaning machine) and N4 (ballast plough) and they were measured close to the subjects' ears.

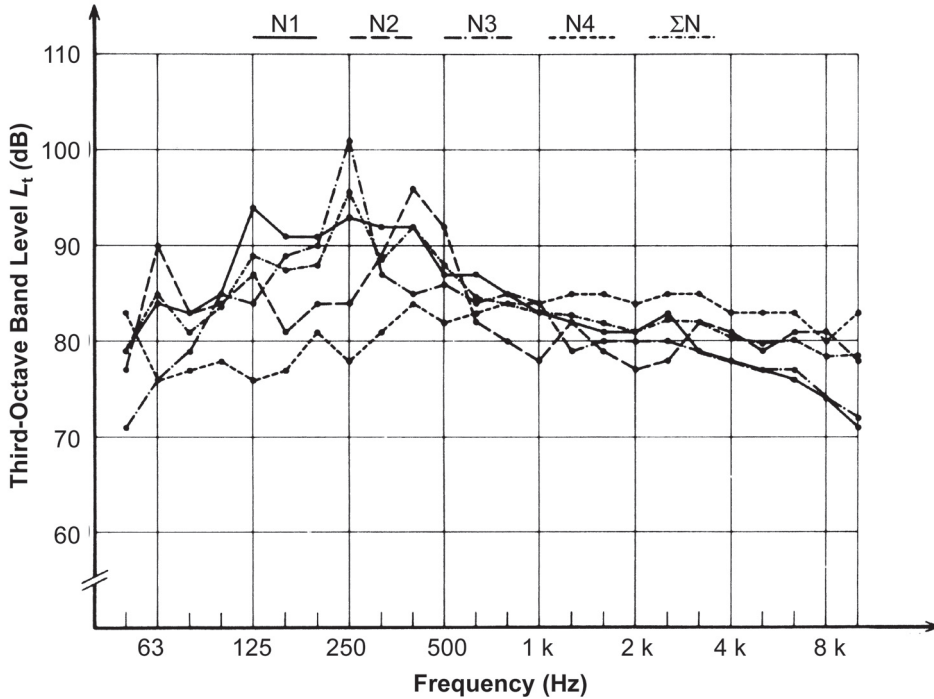

Figure 2. Third-octave band level  $L_t$  of noise N1, N2, N3, N4 and of the averaged level about the four kinds of noise ( $\Sigma N$ ); noise level  $L_{NA} = 96$  dB. Each kind of noise (N1–N4) was averaged over 8 s, the average level ( $\Sigma N$ ) is the average over  $4 \times 8$  s, all given as an equivalent continuous sound level.

The tyfon signal is used as an alarm during track construction work. It consists of two sounds: a low one (basic frequency of 225 Hz) and a high one (basic frequency of 675 Hz). During track work the sounds are emitted singly or mixed, and so it

is possible to use three sounds: high (H), low (L) and mixed (M). In this study two signal types, high-mixed (HM) and high-low (HL), with a duration in each case of  $2 \times 1 = 2$  s, were used (Figures 3, 4).

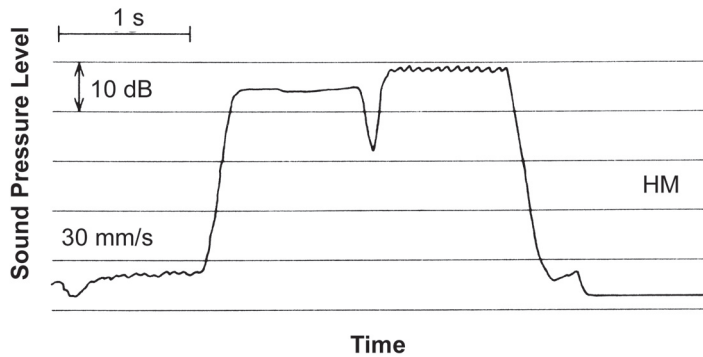

Figure 3. Sound pressure level of the tyfon high-mixed signal (HM) over time.

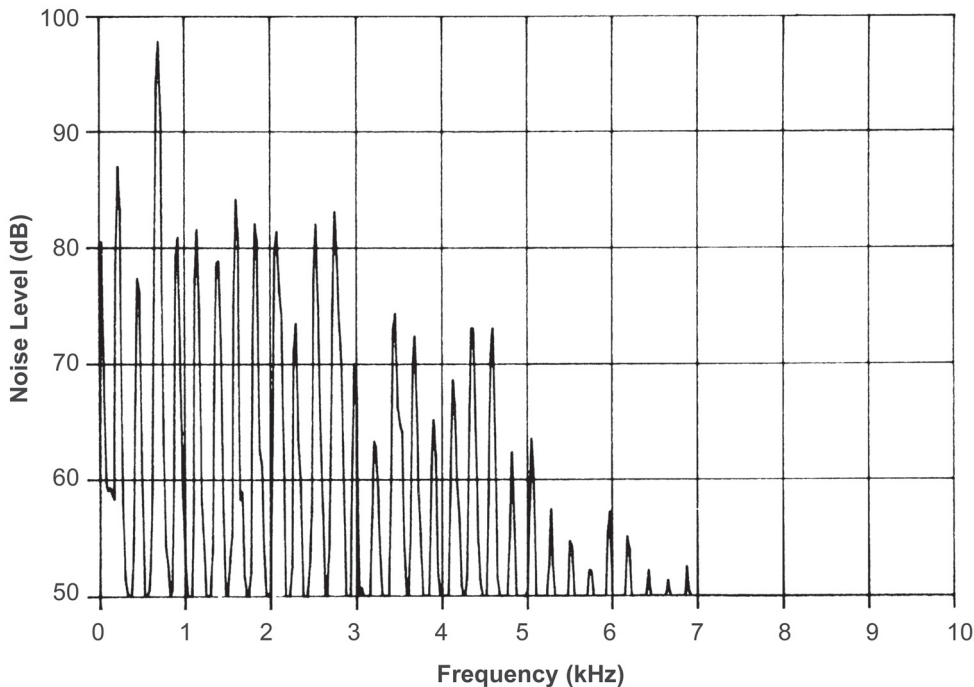

Figure 4. Narrow-band analysis ( $\Delta f = 25$  Hz) of the mixed tyfon signal, averaged over 0.5 s ( $L_{SA} = 96$  dB).

#### 4.2 Group of Subjects, Hearing Losses

Two groups of subjects took part in the psycho-acoustic investigations: 18 normally hearing, male students aged between 23 and 30 (average age: 27) and 45 male German Rail employees aged between 26 and 60 (average age: 49). Since the tyfon signal has its main frequencies in the range of 0.25–3 kHz, the average for three frequencies 0.5/1/2 kHz  $L_{HLT,5/1/2}$  in dB was referred to to evaluate the tonal hearing tests. For the students with normal hearing it was  $L_{HLT,5/1/2} = 3$  dB; the greatest hearing loss between 0.125 and 4 kHz was  $L_{HLT} = 20$  dB.

Among the German Railway employees there were individuals with normal hearing through to those with serious hearing impairment mainly with sensorineural impairment on both sides. The average for tonal hearing losses with the frequencies of 0.5/1/2 kHz was  $\bar{L}_{HLT,5/1/2} = 2\text{--}83$  dB. The 45 railway employees were divided into three groups, each with 15 individuals, in the order of rising hearing loss. The average hearing loss of the German Railway employees had been divided into three groups was  $\bar{L}_{HLT,5/1/2} = 6/24/56$  dB.

#### 4.3. Test Concept

There were four kinds of noise (N1–N4) and two signals (HM, HL). The levels of the four kinds of noise were fixed at  $L_{NA} = 95/96/97$  dB (noted 96 dB) and more, and less 10 dB for the experiments: noted 106 dB and 86 dB. The subjects were presented with signals at five different sound levels in 5-dB increments for each of the two signals (level range 20 dB). The level of the two signals was adjusted to the four kinds of noise in such a way that, with the signal levels presented, the whole range in which the signals were not heard at all or heard 100% was largely covered. So the maximum level of the signals were  $L_{SA} = 93\text{--}98$  dB for HM and  $92\text{--}97$  dB for HL, referred to the single four noises. Then there were eight fixed signal-to-noise ratios between  $L_{SA(max)} - L_{NA} = -4$  to 2 dB. For hearing-impaired subjects the signal levels were raised by 5 dB. The order of the two signals, HM and HL, the signal level and the length of pause (4/6/8 s) were random. Each signal was presented 8 times at a corresponding signal level with noise (signals HM, HL:  $2 \times 8 \times 5 = 80$  signals). Before each tests the subject was informed about the signals to be heard and the test sequence. Furthermore, before the main test, the subjects were given an informative tape (5 min) with two signals, HM and HL, and three

**TABLE 1. Test Sequence in Hearing Protection Test (Experiments 1 and 2) With Preliminary Test, Noise and Hearing Protection**

Noise Sequence		PT		Hearing Protection Test						
		PN	B	N	B	N	B	N	B	N
Number of Signals	HM	20	—	40	—	40	—	40	—	40
	HL	20	—	40	—	40	—	40	—	40
Duration (min)		6	5	11.5	5	11.5	10	11.5	5	11.5
Exp.	$L_{NA}$ (dB)	HP								
1	86	W, P, EM, —								
1	96	W, P, EM, EMB								
2	96	W, P, EM, EMB								
1	106	—, P, EM, —								

Notes. PT—preliminary test, PN—pink noise, B—pause, N—noise 1–4, HM—high-mixed sounds, HL—high-low sounds, Exp.—experiment,  $L_{NA}$ —noise level, HP—hearing protection, W—without hearing protection, P—plug, EM—muff, EMB—muff with selected band filters.

partial signals which made up the two tyfon signals, namely, H, L and M. The subject was told that the signals to be heard in the test (HM, HL) would be interfered with by noise. When he heard the signal, he had to answer “yes” and then identify the signal: “yes, high-mixed” or “yes, high-low”. Since it could happen that only one partial signal was heard, answers “yes, low”, “yes, high” and “yes, mixed” were also admissible. The sequence for the HP tests is outlined in Table 1.

**4.4. Test Arrangement**

The tests took place in a small low-reflection room ( $4 \times 2 \times 2 \text{ m}^3$ ). The subject sat 2 m from the two

loudspeakers, his head on the axis of the mid-range emitter of the loudspeaker (Figure 5). To record possible irregularities in the sound field at the subject’s head, the third-octave sound frequencies of pink noise (PN) emitted by the loudspeakers were measured in an axial cross 10 cm to the right/left, front/rear and up/down of an anticipated head. The deviations were +3 dB in the frequency range from 100 to 10 kHz. The noise and the signals were transferred to two tape recorders, through a mixing console and a pre-amplifier to the loudspeakers. The signal-to-noise ratio was set in an attenuator and at the pre-amplifier.

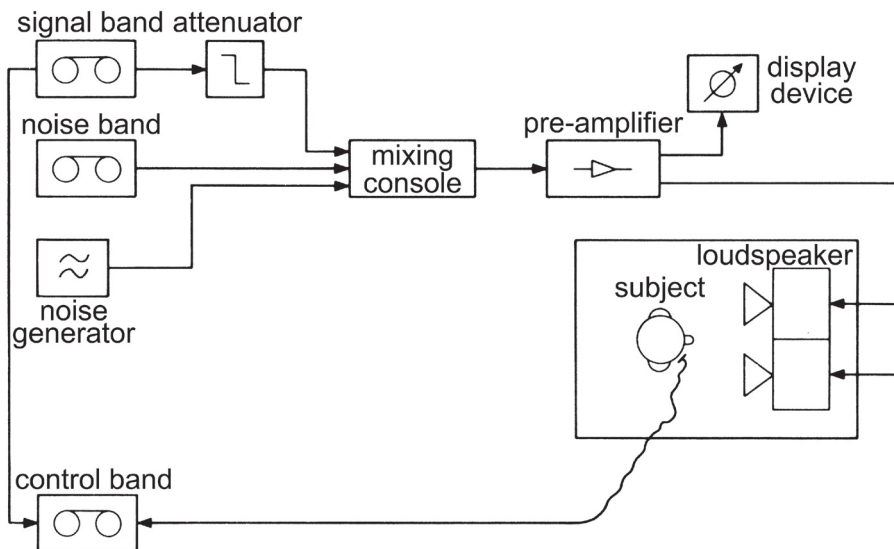

**Figure 5. Experimental setup.**

The subjects' answers were recorded with a throat microphone and, in order to facilitate a clear correlation of the signal and the response, at the same time that the signals were played.

In each test (57/46 min) the subject wore ear plugs, ear muffs or neither. To ensure that no positioning effects could take place in the eight tests, each subject began with a different test.

#### 4.5. Test Sequence

During the test (Table 1) the subject was given a noise-and-signal tape (N, 11.5 min); between those four individual presentations the subject took a break (B) of 5–10 min; the main test lasted 46 min; the subject wore hearing protection for part of the test (Table 1). Before each test a preliminary test (PT) was conducted with PN exposure ( $L_{NA} = 86$  dB) and 40 signals. No HP were worn for the PT. Experiment 1 was an HP test involving only the 18 students with normal hearing. Experiment 2 was an HP test in which the 45 company employees participated. The test was aimed at determining recognition capacity with differing hearing loss (only Experiment 2). The experiments were carried out in four hearing protection situations: without hearing protection (not Experiment 1 at level 106 dB), with plugs, with muffs (only Experiment 1) and with muffs B. The sound level of the noises was  $L_{NA} = 86$  to 106 dB in Experiment 1 and only  $L_{NA} = 96$  dB in Experiment 2. The sequence of the test is given in Table 1.

## 5. RESULTS

### 5.1. Processing of the Results

The test with HP can be divided into sections of 12 min each. For each section, characterised by the noise level ( $L_{NA}$ ), HP and the noise (N), the subjects' answers were evaluated for the individual signal levels ( $DL$ ) and signals (HM, HL). Hearing performance ( $h$ ) was described by the number of signals heard ( $S$ ) and the number of correctly identified signals HM or HL ( $S_{max} = 8$  for each signal,  $h = S/8 = 0$  to 1).

From the respective values for hearing and/or identification performance ( $h$ ) for the five signal levels a psychometric function was calculated:

$$a + b \cdot DL = \text{Arctgh} \left( \frac{2h - 1}{g} \right), g = 1.1.$$

From this psychometric function [23], which gave the average rise in hearing or recognition performance with the signal-to-noise ratio ( $DL$ ) for each individual subject and test situation, the parameters were determined which were the basis of the evaluation. The threshold ( $M$ ) and the masked slope ( $A$ ) was  $M = DL(0.5) = -\frac{a}{b}$ ;  
 $A = DL(0.6) - DL(0.4)$ .

The measure for hearing and identification performance was primarily the masked threshold ( $M$ ), but also the slope of the signal ( $A$ ). Evaluation of the data with a variance analysis, which assumed normal distribution in the data, was possible because normal distribution in the data for the threshold ( $M$ ) and the slope ( $A$ ) of the signal level was probable, in contrast to the subjects' answers with high- and low-level values ( $DL = -20$  and  $DL = 0$ ), where nonlinear limitation effects occurred (ceiling effect). A portion of the data was evaluated using distribution-free test procedures [24] and the results of those tests essentially agreed with those of this report [25].

Variance analyses and Scheffé tests [26, 27] gave  $F$ -values. Those  $F$ -values ( $F(n_1/n_2)$ ) were checked with regard to the error probability of  $p = .1$  on the basis of the  $F$ -distribution.

### 5.2. Hearing and Identification Performance of Subjects With Normal Hearing (Experiment 1, Students)

The direct results of the study (percentage of signals heard) are shown in the form of examples in Figure 6. The averages of masked thresholds are shown in Figure 7.

Taking data of Experiment 1 the influence of the sound pressure level ( $L_{NA} = 86/96/106$ ), the different kinds of noise ( $N = N1-N4$ ) and the signals ( $S_i = HM, HL$ ) were checked with respect to hearing performance as a function of HP (ear plugs, P; ear muffs EM, ear muffs B, EMB; without HP, W). Corresponding to the design (Table 1) several three-factor variance analyses

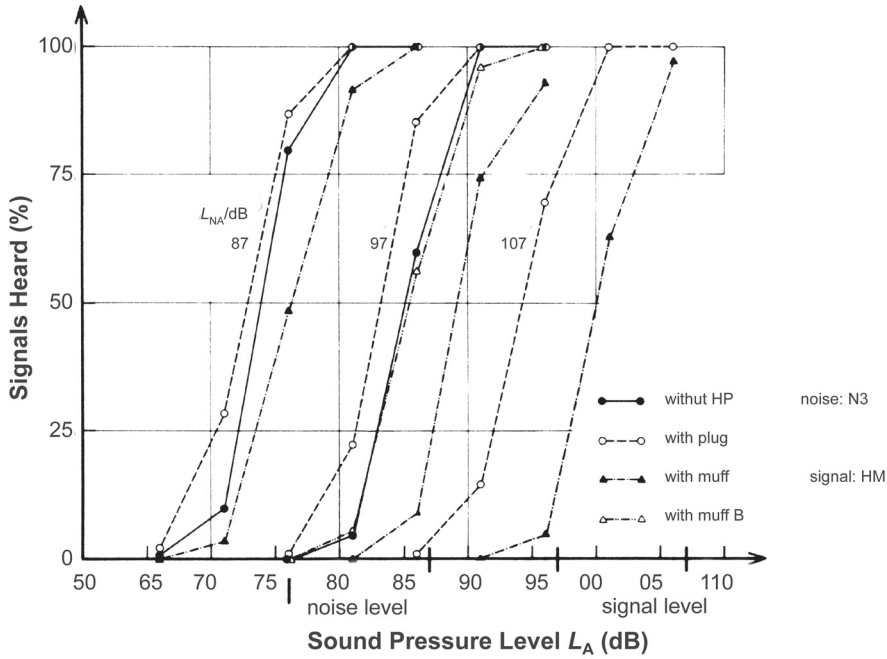

Figure 6. Percentage of signals heard at signal levels ( $L_A$ ) for the high-mixed (HM) signal, during noise (N3) with the sound pressure levels  $L_{NA} = 87/97/107$  dB, with and without hearing protection. Notes. HP—hearing protectors.

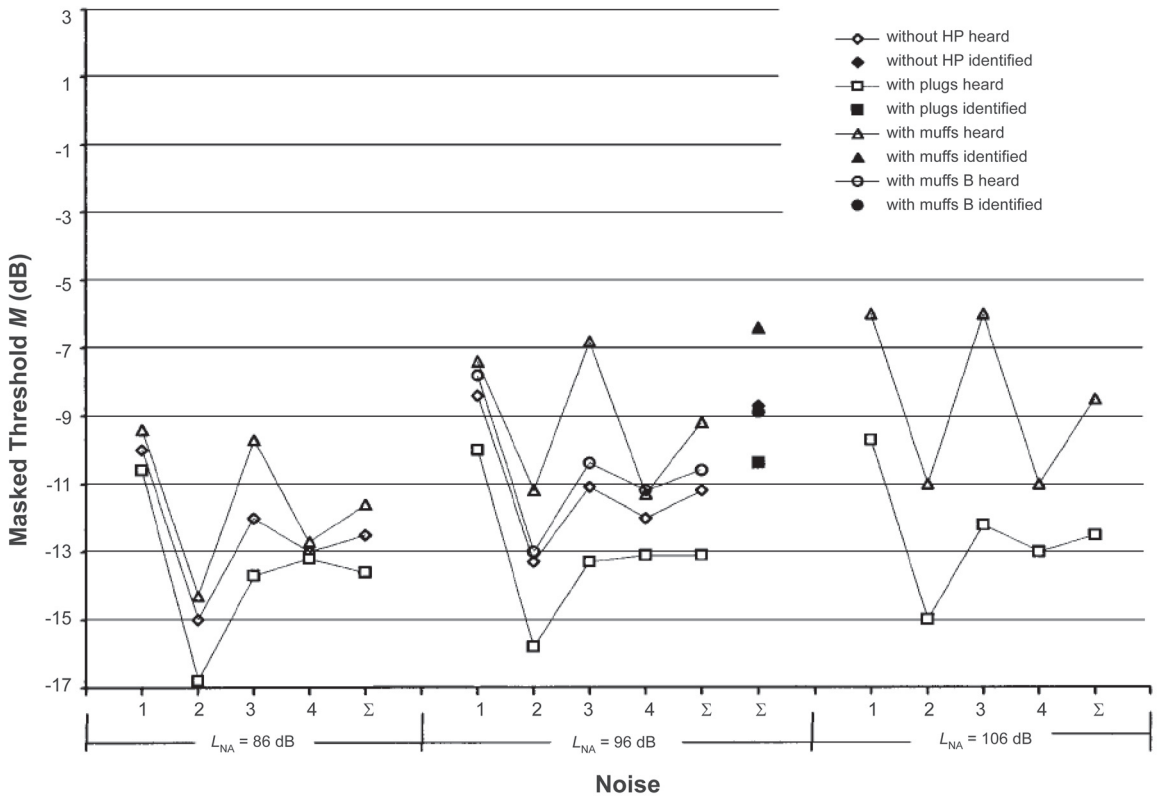

Figure 7. Masked threshold ( $M$ ) of students for the high-mixed (HM) signal with noise (N: 1, 2, 3, 4,  $\Sigma$ ) and different levels ( $L_{NA} = 86/96/106$  dB) without and with hearing protection (plug, muff, muff B): signal heard (open sign) and identified (filled sign). Notes. HP—hearing protectors.



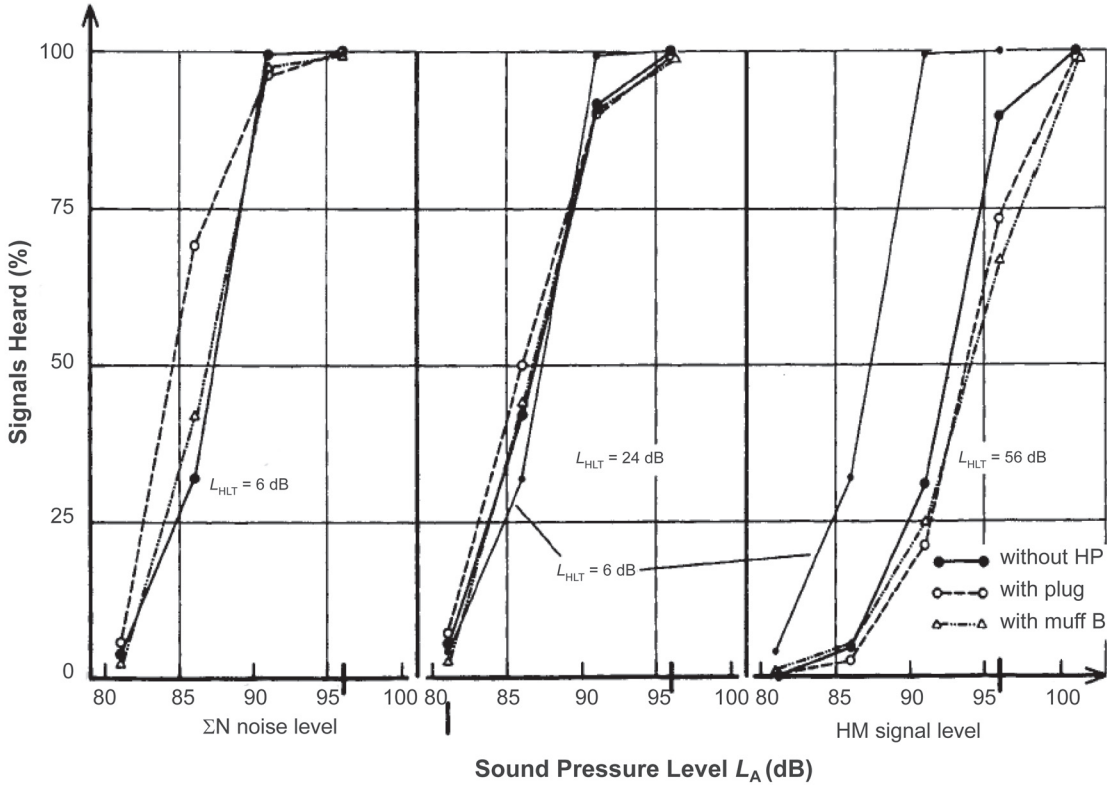

Figure 8. Percentage of signal, heard from employees with hearing loss ( $L_{HLT.5/1/2} = 6/24/56$  dB) at the sound pressure level ( $L_A$ ) of the high-mixed (HM) signal, averaged over noise N1–N4 (noise level  $L_{NA} = 96$  dB). Notes. HP—hearing protectors.

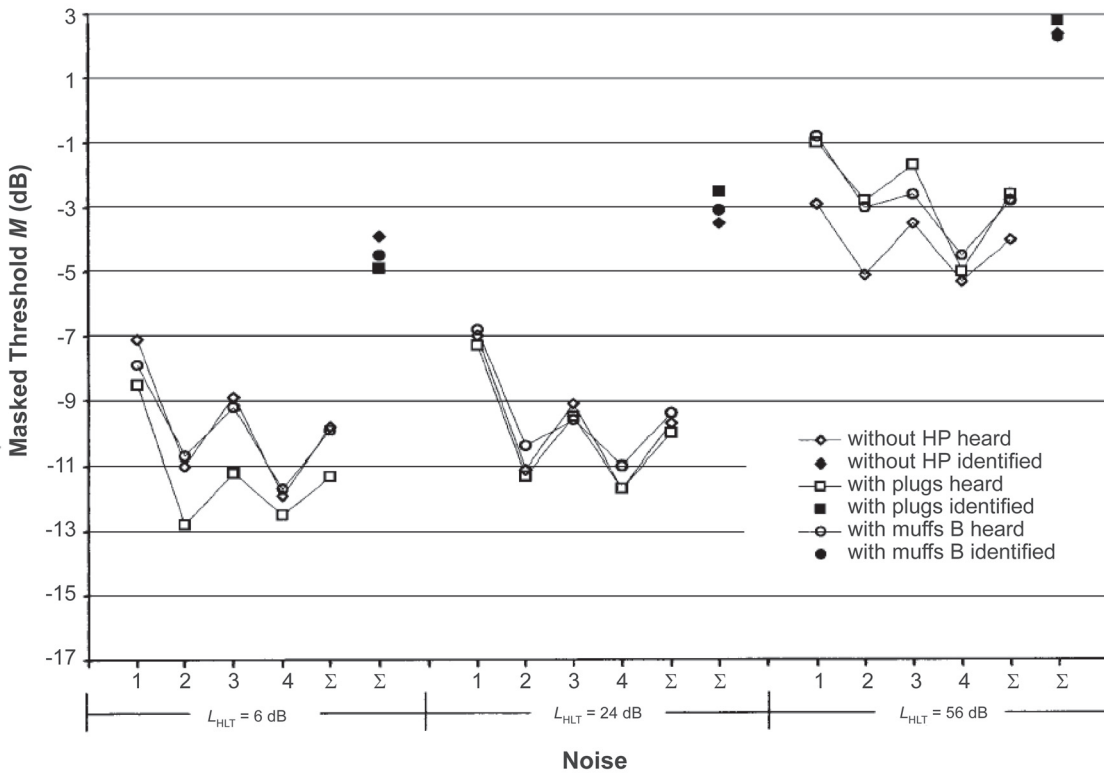

Figure 9. Masked threshold ( $M$ ) of employees with hearing loss ( $L_{HLT.5/1/2} = 6/24/56$  dB) with noise (N: 1, 2, 3, 4,  $\Sigma$ ); level  $L_{NA} = 96$  dB, for the high-mixed (HM) signal, without and with hearing protection (plug, muff B); signal heard (open sign) and identified (filled sign). Notes. HP—hearing protectors.

were conducted with repeated measurements, the factors were differently graded ( $L_{NA} \times HP \times N = 3 \times 2 \times 4$ ;  $2 \times 3 \times 4$ ). The  $F$ -values of the noise level of the factors ( $L_{NA} = 86/96/106$  dB:  $F(2, 34) = 26.1$ – $28.6$ ;  $L_{NA} = 86, 96$  dB:  $F(1, 17) = 19.0$ – $27.4$ ), noise ( $N = N1$ – $N4$ :  $F(3, 51) = 164$ – $175$ ;  $F(3, 51) = 192$ – $222$ ) and hearing protection ( $HP = P, EM$ :  $F(1, 17) = 133$ – $159$ ;  $HP = W, P, EM$ :  $F(2, 34) = 40.9$ – $51.3$ ) were significant for the two signals (HM, HT).

The  $F$ -values of the interaction effects indicate that the influence of HP changes with the noise level (interaction effect HP:  $L_{NA}$ ) and also with the noise (interaction effect HP-N).

The influence of the factors of noise level, type of noise and HP on hearing performance ( $M_{HT}$ ) ( $M$ —masked threshold; HT—hearing threshold) can be seen in Figure 7. Hearing performance ( $M_{HT}$ ) generally decreases as the noise level rises. The deterioration in hearing performance, i.e., the rise in the masked threshold with the rising level, is clear. The masked threshold increases with the rise in noise level from  $L_{NA} = 86$  to  $96$  or  $106$  dB by  $DM_{HT,W,P,EM} = 1$  to  $3$  dB.

The influence of hearing protection on the hearing capacity can be seen in a significant change in the masked threshold ( $M_{HT}$ ) when plugs, rather than muffs, are worn. With individual noises at  $L_{NA} = 96$  dB, the improvement in the masked threshold is on average  $DM_{HT,P-W} = -(1$  to  $3)$  dB with plugs, and the deterioration caused by muffs is  $DM_{HT,EM-W} = 0$  to  $6$  dB (Figures 6, 7). But the hearing threshold when HP are worn is additionally determined by the type of noise. Comparing N3 and N4 (at  $L_{NA} = 96$  dB, signal HM), the masked threshold is almost equal for the unprotected ear and for plugs for N3/N4  $M_{HT,W} = -11.1$  dB/– $12.0$  dB and  $M_{HT,P} = -13.3$  dB/– $13.1$  dB. If, on the other hand, ear muffs are worn, the masked threshold only deteriorates with the noise N3; for N3  $M_{HT,EM} = -6.8$  dB and for N4 it still holds that  $M_{HT,EM} = -11.3$  dB.

Masked thresholds ( $M_{RT}$ ) are given in Figure 7. The masked threshold for the signals heard is on average  $M_{HT} = -11.4$  dB and rises for correctly identified signals by  $DM_{RT-HT} = -2.2$  dB to  $M_{RT} = -9.2$  dB. The deviations between the masked threshold of signals correctly heard and those correctly identified, however, increase with noise

N3 and when ear muffs are worn by  $DM_{RT-HT} = 3$  dB.

### 5.3. Hearing and Identification Performance of Subjects With Hearing Losses (Experiment 2, Railway Employees)

The results of Experiment 2 serve to check the influence of the hearing threshold of subjects ( $L_{HLT.5/1/2} = 6/24/56$  dB), of different noise ( $N = N1$ – $N4$ ) and of signals (HM, HL) on hearing performance ( $M_{HT}$ ) when HP are worn (ear plugs, P; ear muffs B, EMB; without HP, W); for results see Figures 8 and 9. The effect of muffs was no longer tested for persons with hearing losses because clear disadvantages of the muffs were already evident with normally hearing persons. Three-factor variance analyses were conducted with repeated measurements, the factors being differently graded.

As can be seen from variance analyses ( $L_{HLT} \times HP \times N = 3 \times 3 \times 4$ ), the factor of the hearing threshold of the subjects ( $L_{HLT}$ :  $F(2, 42) = 38.3$ – $41.8$ ) and noises ( $N$ :  $F(3, 126) = 114.0$ – $222.0$ ) at signals (HM, HL) was significant. The influence of HP can be seen in the significant  $F$ -values of the interaction effects ( $F(4, 84) = 3.99$ – $6.78$ ), i.e., HP influence hearing performance ( $M_{HT}$ ) only if the influence of the subjects' hearing loss or noise is also included. Figure 8 outlines the proportion of the signals heard in relation to those presented.

The influence of the subjects' hearing loss ( $L_{HLT}$ ) on the masked threshold is very clear (Figure 9): the masked threshold increased significantly on average  $DM_{HT,56-6} = 7$  dB in the group of subjects with a hearing loss of  $L_{HLT.5/1/2} = 56$  dB as compared to the two groups of subjects with lower hearing losses ( $L_{HLT.5/1/2} = 6/24$  dB). In the two groups of subjects with low hearing losses ( $L_{HLT.5/1/2} = 6/24$  dB) hearing performance increased slightly due to the ear plugs (as compared to no HP): the masked threshold fell in the group with normal hearing ( $L_{HLT} = 6$  dB) on average by  $DM_{HT,P-W} = -1.5$  dB, and this improvement was partly significant. In the group with a hearing loss of  $L_{HLT} = 24$  dB the masked threshold remained unchanged. For the group of the hearing-impaired ( $L_{HLT} = 56$  dB) it can be seen that there was a

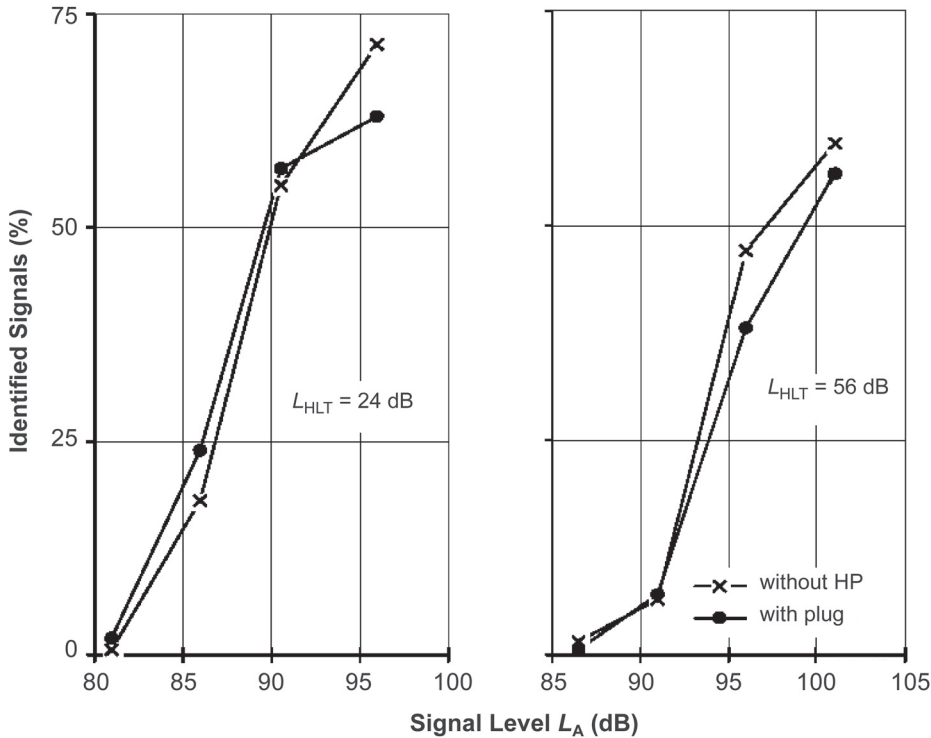

Figure 10. Percentage of signal identified from employees with hearing loss ( $L_{HLT.5/1/2} = 24/56$  dB) at the signal level ( $L_A$ ) of the high-mixed (HM) signal, averaged over the noises N1–N4 (noise level  $L_{NA} = 96$  dB); with and without plugs. Notes. HP—hearing protectors

significant deterioration in the masked threshold of  $DM_{HT,P-W} = (1-3)$  dB when ear plugs were worn.

The results for the identification performance are given in Figure 10, the corresponding masked thresholds ( $M_{RT}$ ) are given in Figure 9 averaged over noise. For the hearing-impaired ( $L_{HLT} = 56$  dB) the hearing and identification performance ( $M_{HT}$ ,  $M_{RT}$ ) was significantly lower than that for the subjects with a hearing loss of  $L_{HLT} = 6/24$  dB. The influence of HP—indicated by the interaction effect with the masked threshold—can be seen for those with normal hearing ( $L_{HLT} = 6$  dB) in the partly significant reduction by  $DM_{RT,P-W} = -1.5$  dB in the masked threshold ( $M_{RT}$ ) for the correctly identified signals (HM, HL) when the ear plugs are worn (P) as against the unprotected ear (W). For the hearing-impaired subjects ( $L_{HLT} = 56$  dB) the masked threshold deteriorated significantly by  $DM_{RT,P-W} = 2.5$  dB when ear plugs or ear muffs B were worn as compared with the unprotected ear.

## 6. DISCUSSION OF THE RESULTS

The reduction in hearing capacity with a rising level and a highly interesting difference in hearing performance between individual HP situations can be explained by the masking and loudness theory [9, 28]. Using Zwicker’s loudness method [28, 29] it is possible to calculate in advance the masked threshold from the loudness of the noise and of the signal in each frequency group (critical band). If one wishes to estimate the effect of wearing HP, i.e., a frequency-dependent reduction in the sound level, a distinction must be drawn between the masking within the critical band and remote masking. A reduction in level has little influence over masking. Within the critical band or one-third-octave band the signal-to-noise ratio  $DL_t = L_{St} - L_{Nt}$  is maintained but the non-linearities are poorer [11]. Therefore a largely frequency-independent level reduction improves the hearing capacity. This explains the better hearing performance at levels of about 70 dB (with plugs) compared to levels of about 90 dB (without plugs) (Figure 6)

and the lower masked threshold when plugs are used (Figures 6, 7).

In the case of noise where sound intensity varies considerably over the frequency, remote-masking must also be included. Remote masking increases as the intensity of the masking noise grows, mainly the signal fractions of the frequencies being masked whose frequencies are higher than those of the noise (upward-spread of masking). The spectrum of the masking noise thus also exercises an influence on the change in signal recognition due to the wearing of HP. Noise with high sound levels at frequencies of up to 0.5 kHz has a greater masking action when muffs are worn than for broadband or high-frequency noise. The ratio of the intensity of lower-frequency noise to the intensity of higher-frequency signals can increase up to 20 dB if muffs are worn [30].

For noise with stronger sound levels at frequencies below 500 Hz (noise N1, N2, N3,  $L_{NA} = 96$  dB) the difference in masked thresholds (for the signals HM and HL) when ear plugs (P) and muffs (EM) are being worn in relation to the unprotected ear (W) is  $DM_{HT,P-W} = -(0.5 \text{ to } 2.5)$  dB and  $DM_{HT,EM-W} = (0.5 \text{ to } 5.5)$  dB, respectively; for noise with larger portions of higher frequencies (noise N4) only small differences were obtained for the masked thresholds: with ear plugs and with muffs  $DM_{HT,P-W} = -(1 \text{ to } 1.5)$  dB and  $DM_{HT,EM-W} = (0 \text{ to } 1)$  dB (see also Figure 7).

The differences calculated using Zwicker's loudness methods and those determined in the experiment are of the same magnitude. The predictions, made in accordance with the calculation procedure [25, 31], that N1, N2, N3 worsen hearing performance when ear muffs are worn (as compared to no HP) and that the noise N4 hardly changes hearing performance are true. The hearing performance of a plug-protected ear is not much better.

The fact that in the studies to date there have been reports in some case of no changes [14] or only improvements [12] in hearing performance of normally hearing subjects when HP are worn is probably due to the selection of the noise spectrum and the type of HP. For example, Levin only used broadband noises whose octave levels were largely independent of the frequency. In addition

the results for a number of HP were averaged with different sound attenuation. Lessing and Sauer [12] conducted their study with ear muffs which already had a very high sound attenuation at low frequencies, and furthermore the noise spectrum from 200 Hz is largely independent of frequency.

The only way to predict hearing performance is to take into account information about frequency distributions. So the loudness method can be used to ensure adequate perception of signals and interfering noises with and without HP [25, 32]. On the one hand it was checked whether the loudness of the signal was greater than that of the interfering noise in at least one frequency band; on the other the total increase in loudness from the signal was determined. On the basis of the change in this determination of loudness it is possible to check the influence of HP. These procedures are used successfully in selecting HP for noise areas in road traffic and railway systems [31, 33, 34, 35].

The influence of the subjects' hearing threshold on hearing performance was examined in Experiment 2, only with plugs. The third-octave band level of the noises and the tyfon signals were, in the frequency range of  $f_t = 0.25\text{--}2$  kHz ( $L_{NA} = 96$  dB), higher than  $L_{St}$ ,  $L_{Ni} > 80$  dB; the company employees' hearing losses were in most cases  $L_{HLT,f} < 80$  dB in this range. Although for nearly all company employees the third-octave band levels of the noise and the tyfon signals were clearly above the subjects' quiet hearing threshold, the masked threshold (for the signals HM and HL) acquired higher values with increasing hearing loss. As the average hearing loss ( $L_{HLT} = 6/24/56$  dB) increased, the masked threshold increased; with the unprotected ear it was  $M_{HT} = -10/-9.9/-4.3$  dB and  $M_{HT} = -11.4/-10.2/-2.2$  dB when plugs were worn (for corresponding values for HM see Figure 9). A higher masked threshold for signals for subjects with hearing loss was also observed by other authors [36, 37, 38]) and also for speech [39]. It is partly assumed that at higher sound levels and with hearing-impaired persons the auditory filters of the perception are wider [40].

The calculation of a linear regression (Figure 11) yielded a rise in the masked threshold of the tyfon signals for the unprotected ear and for the ear protected with ear plugs of  $DM_{HT,W} = 1.2$  dB and

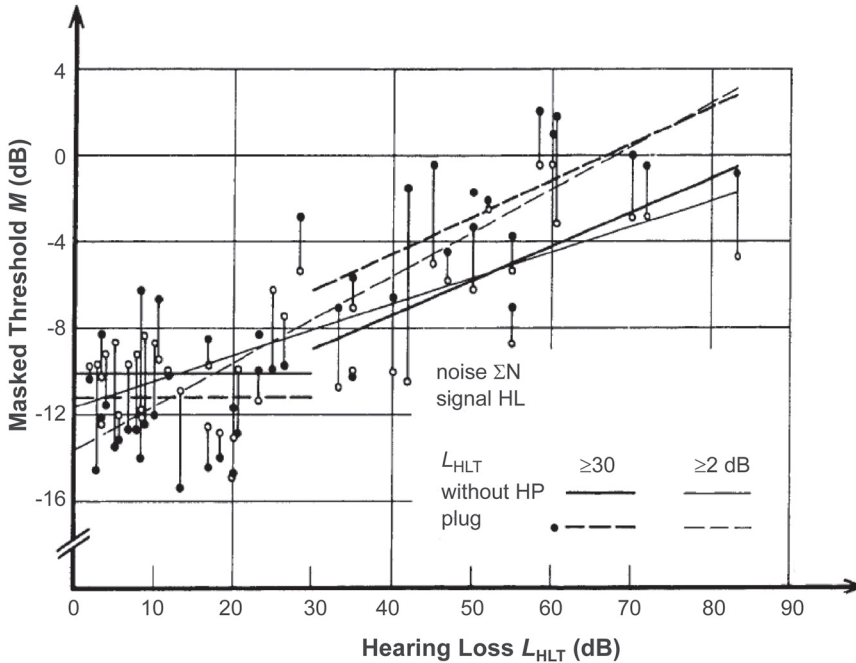

**Figure 11.** Linear regression between masked threshold ( $M$ ) and hearing loss ( $L_{\text{HLT},5/1/2} \geq 2/30$  dB) for 45/18 subjects, high-low (HL) signal, four kinds of noise ( $\Sigma N$ ),  $L_{\text{NA}} = 96$  dB. Notes. HP—hearing protectors.

$DM_{\text{HT,P}} = 1.9$  dB, respectively, per 10-dB rise in the average hearing loss over the frequencies 0.5/1/2 kHz.

Figure 11 reveals that with low hearing losses—as also shown in this section—the masked threshold with the use of ear plugs was lower than with the unprotected ear. Only with hearing losses of above  $L_{\text{HLT}} = 20\text{--}30$  dB did the masked threshold with ear plugs exceed that without HP. Two groups of subjects were therefore formed in each case for the range above and below the hearing loss of  $L_{\text{HLT}} = 30$  dB. Below the limit for the masked threshold the average was formed, and above the limit a linear regression was calculated. This is shown in Figure 11. The correlation coefficients were calculated from the masked thresholds above the limit of  $L_{\text{HLT}} = 30$  dB for 18 subjects ( $r = .56\text{--}.65$ ). They did not differ substantially from those for all 45 subjects ( $r = .74\text{--}.85$ ). Tyler [37] indicated for sinus tones masked by white noise, a correlation of between hearing loss and the level of the sinus tones. Lessing and Sauer [12] also reported deterioration in hearing performance of subjects with a rising hearing loss when wearing HP as compared with the unprotected ear.

With the subjects' hearing loss all types of noise caused a slight different increase of the masked

threshold. Noise (N1, N2, N3) with a higher proportion of low frequencies influenced hearing performance somewhat more than noise with higher frequency portions. The difference between the masked threshold (for the signals HM and HL) for the ear protected by ear plugs and that for the unprotected ear was for the three groups of subjects with average hearing losses  $L_{\text{HLT}} = 6/24/56$  dB for the three kinds of noise (N1, N2, N3)  $DM_{\text{HT,P-W}} = -2/0/(2\text{--}3)$  dB, and for the noise N4  $DM_{\text{HT,P-W}} = -0.5/0/1$  dB (see also Figure 9). The somewhat increased masking of the signals by low-frequency noises for subjects with greater hearing losses could be due to the more pronounced remote masking with impaired-hearing persons [37, 38].

If one compares the influence of HP, which is of particular interest here, while taking account of the hearing losses between the signals HM and HL heard and those correctly identified, it can be seen that the identification of signals is especially difficult under conditions where hearing performance takes on a poor value, too. With normally hearing subjects hearing performance and identification performance improve when ear plugs are used (as compared to no HP) by  $DM_{\text{HT,P-W}} \approx DM_{\text{RT,P-W}} = -(1 \text{ to } 2)$  dB (Figures 7, 9). On the other hand the difference in

the masked threshold between the situation where muffs are worn and that without HP increases for identification performance ( $M_{RT}$ ) as against hearing performance ( $M_{HT}$ ) for low-frequency noise; for that noise (N1, N2, N3) the following holds:  $DM_{RT,P-W} = (1 \text{ to } 8) \text{ dB}$  as against  $DM_{HT,P-W} = (1 \text{ to } 6) \text{ dB}$ . On average the increase in the masked threshold for identification tasks is for the normally hearing and for the hearing-impaired subjects ( $L_{HLT} = 3 \text{ to } 6, 56 \text{ dB}$ ) about the same ( $DM_{RT-HT} = 5\text{--}7 \text{ dB}$ ) (Figures 7, 9).

The results for hearing performance for ear muffs fitted with band filters are among the normally hearing subjects and those with impaired hearing at about the same level as the results obtained for the unprotected ear (Figures 7, 9).

## 7. SHORT SUMMARY

The results of the hearing tests can be summarised as follows. For subjects with normal hearing the hearing tests showed that, when ear plugs were worn, on average the subjects' hearing performance slightly improved (as compared to no HP). If, however, the subjects wore ear muffs, on average their hearing performance deteriorated. Depending on the interference noise the subjects were exposed to, the reduction in hearing performance varied when ear muffs were used. The low-frequency interference noise (N3) gave rise to a major deterioration in hearing performance when ear muffs were worn (as compared to no HP), while with the high-frequency interference noise (N4) hearing performance remained almost unchanged (Figures 6, 7).

If the subjects whose average hearing loss—measured at the frequencies of 0.5/1/2 kHz—did not exceed 20 dB wore ear plugs, the tyfon signals were heard on average equally well or slightly better. But if the hearing losses were above 20 dB and those subjects wore ear plugs, the higher their hearing losses, the more their perception of the tyfon signals deteriorated (as compared to HP) (Figures 8, 9).

A masked threshold of 1 dB corresponded to about 10 to 15% of heard or identified signals. For example, if the percentage of signals heard was about 50% for the unprotected ear, then the

subjects heard about 75% with plugs (masked threshold  $-2 \text{ dB}$ ) and less than 10% with muffs (masked threshold 4 dB) (noise N3,  $L_{NA} = 96 \text{ dB}$ , signal HM; Figure 6).

## 8. PROPOSALS FOR NOISY AREAS

The general conclusion is that when selecting HP, the frequency distribution of noise, signals, attenuation and hearing loss has to be taken into consideration. But where HP cannot be adapted to the spectrum of the signals and noise, which is normally the case, hearing protection with, as far as possible, frequency-independent attenuation (plugs) should be used and the hearing loss of the people (using it) should be small.

With the help of the results of these experiments it is possible to estimate the influence of individual parameters on signal recognition. It is intended here not only to show the influence of the individual parameters of this experiment on the masked threshold, as can be seen in Figures 7 and 9. It is also intended to estimate roughly the maximum variation for these parameters (given in brackets). The level and spectrum of the noise (5 dB), the hearing protection (8 dB), the nature of the signal (3 dB) and the hearing loss (10 dB) are the influencing factors. Additionally it must be taken into consideration that the masked threshold increases at up to 10 dB if subjects do not concentrate on signal recognition, which is normally the case, but on the work task [41]. Furthermore the threshold of identification is approximately 3–7 dB above the threshold of hearing (Figures 7, 9). Of course these values and their variations were only derived from the parameters used in these experiments. However, the sound level and spectrum of the noise, the hearing protection and the hearing losses varied considerably systematically and so it seems possible to make generally applicable statements within certain limits. However it is questionable whether the difference between hearing and identification, which was only determined for those two signals, can be applied to other signals. Because of the given masked threshold, the psychometric function was known and the signal-to-noise ratio could be calculated for a defined

given hearing performance. For practical purposes the performance for heard or identified signals should be between 90 and 99%. To achieve such a performance the signal-to-noise ratio must be about 3 to 8 dB higher than the masked threshold at 50%. If one considers the influencing factors mentioned, one needs a signal-to-noise ratio of 5 to 10 dB to ensure reliable identification of signals. But if persons with hearing impairment are admitted and offered muffs, and if different signals have to be identified, a signal-to-noise ratio of 10 to 15 dB is necessary.

In the past a discussion on a sufficient signal-to-noise ratio led to similar results. Symanowski [42] referred to a necessary signal-to-noise ratio (99% of the subjects hear the signals) of  $DL_A = 4.5$  to 7 dB. Patterson [43] obtained a result that, to ensure reliable recognition of a danger signal, four or more spectral components must be 15 dB above the masked threshold, but they should not exceed a margin of 25 dB. Tran Quoc and Hétu [44] concluded from their investigations that a danger signal should exceed ambient noise by 13 dB with a third-octave analysis. Wilkins and Martin [45] therefore proposed a margin of between 10 and 15 dB above the masked threshold to ensure that a signal attracts attention and is recognised. Wilkins and Martin [5, 17] pointed out that a signal-to-noise ratio of  $DL = 15$  to 18 dB may not be sufficient to recognise signals that rarely take place. In the specifications of Harris [46] a signal-to-noise ratio of +10 dB was proposed where third-octave filters were used. A summarised study by Malter and Guski [47] also came to the conclusion that a signal-to-noise ratio of  $DL_A/DL = 10$  to 15 dB was necessary.

The results of these experiments and this short overview lead to a necessary signal-to-noise ratio of  $DL_A = L_{SA} - L_{NA} = 10$  to 15 dB, also laid down in ISO 7731:2003 [8] and EN 457:1992 [48] as a general requirement for safe and quick signal recognition. If such high signal-to-noise ratios are not practicable, which is normally the case in situ, e.g., because of high noise levels or an excessive distance between the worker and the signal source, it may arise that signals are overheard and that the risk of an accident is greater. To ensure maximum

identifiability of danger signals the following steps are recommended:

- compliance with ISO 7731:2003 [8] and EN 457:1992 [48],
- adherence to  $DL_A = 15, \dots, 25$  dB,
  - high density of the signal sources (small distance between the signal source and the ear),
  - lowering the noise level ( $L_{NA}$ ) with the help of technical measures [49] and
  - using almost frequency-independent HP (plugs).

If  $DL_A \leq 15$  dB, it is necessary to:

- determine the level and spectrum of the noises and signals,
- determine the employees' audiograms,
- select the signal in accordance with the spectrum of the noise and the audiogram,
- select specific hearing protection according to the level and spectrum of the noise, of the signal and of the audiogram.

## REFERENCES

1. Council Directive 86/188/EEC of 12 May 1986 on the protection of workers from the risks related to exposure to noise at work. Official Journal of the European Communities L 137, May 24, 1986. p. 28–34.
2. Council Directive 2003/10/EEC (2003). Directive of the European Parliament and of the Council of 6 February 2003 on the minimum health and safety requirements regarding the exposure of workers to the risks arising from physical agents: noise (Seventeenth individual Directive within the meaning of Article 16(1) of Directive 89/391/EEC). Official Journal of the European Union, L 42, February 15, 2003. p. 38–44.
3. Lazarus H. Beeinflusst das Tragen von Gehörschutz die Erkennung von akustischen Signalen? [Affects wearing hearing-protectors the recognition of acoustic signals?]. Zentralblatt für Arbeitsmedizin, Arbeitsschutz, Prophylaxe und Ergonomie 1980;30(6):204–12.
4. Lazarus H. The effects of hearing protectors on the perception of acoustic signals (DRIC-

- T-6786). Orpington, Kent, UK: Defence Research Information Centre Translation (DRIC-T); 1983.
5. Wilkins PA, Martin AM. Hearing protection and warning sounds in industry—a review. *Appl Acoust* 1987;21:267–93.
  6. Lazarus H. Recognition of danger signal and speech communication—state of standardization. In: *Noise and Man '93*. Arcueil, France: INRETS; 1993. vol. 3, p. 219–24.
  7. Sanders AF. *Psychologie der Informationsverarbeitung* [Psychology of information processing]. Bern, Switzerland: Verlag Huber; 1971.
  8. International Organization for Standardization (ISO). *Ergonomics. Danger signals for public and work areas. Auditory danger signals (Standard No. ISO ISO 7731:2003)*. Geneva, Switzerland: ISO; 2003.
  9. Zwicker E, Feldtkeller R. *Das Ohr als Nachrichtenempfänger* [The ear as a message recipient]. Stuttgart, Germany: S. Hirzel Verlag; 1967.
  10. Kryter KD. *The effects of noise on man*. New York, NY, USA: Academic Press.
  11. Kryter KD. Speech communication. In: Cott HP, Kinkade RG, editors. *Human engineering guide to equipment design*. Washington, DC, USA: American Institutes for Research; 1972. p. 161–246.
  12. Lessing G, Sauer U. Individueller Gehörschutz und Hörbarkeit akustischer Signale [Individual hearing-protection and audibility of acoustic signals]. *Z ges Hyg* 1979; 25(2):113–7.
  13. Sandstede P. Beitrag zur Ermittlung optimaler akustischer Signaleffekte bei Druck- und Papierverarbeitungsmaschinen [Contribution for the determination of optimal acoustic signal effects with printing- and paper-processing machines]. *Die Berufsgenossenschaft* 1972;8:285–92.
  14. Levin G. Wahrnehmbarkeit akustischer Signale beim Tragen von Gehörschutz [Perception of acoustic signals when wearing hearing-protectors]. *Die Berufsgenossenschaft* 1976;12:471–4.
  15. Jungsbluth K, Meisel R. Untersuchung über die Wahrnehmung akustischer Signale unter Lärmschutzbedingungen bei Gleisstopfarbeiten und deren Schlußfolgerung [Investigation on the perception of acoustic signals under noise conditions during track plugging work and their conclusion]. *Arbeitsschutz* 1973;11(12):446–7.
  16. Abel SM, Kunov H, Pichora-Fuller MK, Alberti PW. Signal detection in industrial noise: effects of noise exposure history, hearing loss, and the use of ear protection. *Scand Audiol* 1985;14:161–73.
  17. Wilkins PA, Martin AM. The effects of hearing protection on the perception of warning sounds. In: Alberti PW, editor. *Personal hearing protection in industry*. New York, NY, USA: Raven Press; 1982. p. 339–69.
  18. Wilkins PA. A field study to assess the effects of wearing hearing protectors on the perception of warning sounds in an industrial environment. *Appl Acoust* 1984;17:413–37.
  19. Wilkins PA, Martin AM. The role of acoustical characteristics in the perception of warning sounds and the effects of wearing hearing protection. *J Sound Vib* 1985;100(2):181–90.
  20. Lazarus H. Identifizierung von akustischen Mustern beim Tragen von Gehörschutz [Identification of acoustic pattern when wearing hearing-protectors]. *Kampf dem Lärm* 1979;26(6):183–8.
  21. Christ E. Persönlicher Schallschutz und Unfallgefährdung [Personal noise protection and accident risk]. *Die Berufsgenossenschaft* 1976;4:474–80.
  22. Fischer RL. Persönliche Mitteilungen und Diagramme über die Schalldämmung eines Kapselgehörschützers mit selektiven Filtern für die Oberwellen des Typhonsignals [Personal reports and diagrams on the sound attenuation of muffs with selective filters for the harmonics of the tyfon signal] [unpublished document]; 1979.
  23. Richards DL, Archbold RB. A development of the collard principle of articulation calculation. *Proceedings of the Institution of Electrical Engineers* 1956;103B:679–91.
  24. Sachs L. *Angewandte Statistik* [Applied statistics]. Berlin Germany: Springer Verlag; 1974.
  25. Lazarus H, Wittmann H, Weißenberger H, Meißner H. Die Wahrnehmbarkeit von



- Rottenwarntypen beim Tragen von Gehörschutz [Audibility of tracklayer warnings when wearing hearing-protectors] (Forschungsbericht der Bundesanstalt für Arbeitsschutz und Arbeitsmedizin, Fb 340). Bremerhaven, Germany: Wirtschaftsverlag NW; 1983.
26. Kirk RE. Experimental design: procedures for the behavioral sciences. Belmont, CA, USA: Brooks/Cole; 1968.
  27. Eimer E. Varianzanalyse. Eine Einführung [Analysis of variance. An introduction]. Stuttgart, Germany: Kohlhammerverlag; 1978.
  28. International Organization for Standardization (ISO). Acoustics: method for calculating loudness level (Standard No. ISO 532:1975). Geneva, Switzerland: ISO; 1975.
  29. Scholl H. Über ein objektives Verfahren zur Ermittlung von Hörschwellen und Mithörschwellen [About an objective procedure for the determination of auditory thresholds and masked thresholds]. *Frequenz* 1963;17(4):125–33.
  30. Lazarus H. Literature review 1978–1983 in German language on noise and communication. In: Rossi G, editor. In: Proceedings of the 4th International Congress on Noise as a Public Health Problem. Milano, Italy: Centro Recherche e Studi Amplifon; 1983. p. 425–51.
  31. Liedtke M. Use of Zwicker Method to predict signal audibility in noise with hearing protection devices. *Acta Acustica* 1999;85(1):205.
  32. Wittmann H, Lazarus H. Einfluß von Gehörschutzmitteln auf die Wahrnehmbarkeit von Rottenwarntypen [Influence of hearing-protection on the perception of tracklayer warnings]. In: Fortschritte der Akustik. DAGA'80. Berlin, Germany: VDE-Verlag; 1980. p. 659–62.
  33. Liedtke M. Selection of hearing protectors to be used in noise areas in road traffic of railway systems in Germany. In: Prasher D, Luxon L, Pyykkö I, editors. Proceedings of the 2nd European Conference on Protection Against Noise. London, UK: Whurr; 1997. vol. 2, p. 177–82.
  34. Liedtke M. Specifying a general criterion for hearing protectors with the aim of ensuring good acoustic perception. *Noise & Vibration Worldwide* 2002;33(7):19–23.
  35. Pfeiffer BH, Hoormann H-J, Liedtke M. Lärmarbeitsplätze in und auf Fahrzeugen im öffentlichen Straßenverkehr: Der Einfluss von Gehörschützern auf die Hörbarkeit von Verkehrssignalen [Noise workplaces in and on vehicles in the public traffic: the influence of hearing-protectors on the audibility of traffic signals] (BIA-Report 5 des Hauptverband der gewerblichen Berufsgenossenschaften). Sankt Augustin, Germany: Berufsgenossenschaftliches Institut für Arbeitssicherheit (BIA); 1997.
  36. Rittmanic PA. Puretone masking by narrow-noise bands in normal and impaired ears. *The J Aud Res* 1962;2:287–304.
  37. Tyler RS, Fernandes M, Wood EJ. Masking, temporal integration and speech intelligibility in individuals with noise-induced hearing loss. In: Talyor IG, Markides A, editors. Disorders of auditory function III. London, UK: Academic Press; 1980. p. 211–36.
  38. Cook JA, Bacon SP, Sammeth CA. Effect of low-frequency gain reduction on speech recognition and its relation to upward spread of masking. *J Speech Lang Hear Res* 1997;40:410–22.
  39. Plomp R. Auditory handicap of hearing impairment and the limited benefit of hearing aids. *JASA* 1978;63:533–49.
  40. Coleman G. The signal design window revisited. *Int J Ind Ergon* 1998;22:313–8.
  41. Sust CA, Lazarus H. Signal perception during performance of an activity under the influence of noise. *Noise Health* 2003;6(21):51–62.
  42. Symanowski H-M. Beurteilung des Lärms und der akustischen Warnsignale an Gleisbaumaschinen [Assessment of the noise and the acoustic warning signals at track laying machines]. *DET—Die Eisenbahntechnik* 1980;28(12):504–6.
  43. Patterson RD. (1982). Guidelines for auditory warning systems on civil aircraft (Paper No. 82017). London, UK: Civil Aviation Authority.
  44. Tran Quoc H, Héту R. La planification de la signalisation acoustique en milieu industriel: critères de conception des avertisseurs sonores de danger [The planning of acoustic

- signalization in industrial area: criteria of sound design for danger signals]. *Canadian Acoust* 1996;24(2):3–17.
45. Wilkins PA, Martin AM. The effect of hearing protectors on the perception of warning and indicator sounds—a general review (Technical Report No. 98). Southampton, UK: University of Southampton, Institute of Sound and Vibration Research; 1978.
  46. Harris R. The selection and specification of audible alarm signals. In: *Proceedings of Internoise 83*. Edinburgh, UK: Institute for Acoustics; 1983. p. 806–8.
  47. Malter B, Guski R. Gestaltung von Gefahrensignalen [Design of danger signals] (Forschungsbericht der Bundesanstalt für Arbeitsschutz und Arbeitsmedizin, Fb 935). Bremerhaven, Germany: Wirtschaftsverlag NW; 2001.
  48. European Committee for Standardization (CEN). Safety of machinery; auditory danger signals; general requirements, design and testing (Standard No. EN 457:1992; ISO 7731:1986 modified). Brussels, Belgium: CEN; 1992.
  49. European Committee for Standardization (CEN). Acoustics—recommended practice for the design of low noise workplaces containing machinery—part 1: noise control strategies (Standard No. EN ISO 11690-1:1996). Brussels, Belgium: CEN; 1996.