

Dynamic Strength Tests for Low Elongation Lanyards

Krzysztof Baszczyński

**Department of Personal Protective Equipment, Central Institute for Labour Protection
– National Research Institute, Łódź, Poland**

Lanyards are still important and common components of personal systems protecting against falls from a height. Experience with dynamic strength tests of lanyards indicates that test methods based on EN and ISO standards do not make objective assessment possible. This paper presents the results of theoretical and laboratory investigations of the performance of adjustable lanyards during fall arrest. The obtained results indicate that methods of testing and assessment based on those standards demonstrate considerable shortcomings when applied to low elongation lanyards. The assumptions for improved requirements and test methods of lanyards made of, e.g., steel wire and aramid ropes are also presented.

personal protective equipment against falls from a height lanyard
dynamic strength test requirements for lanyards

1. INTRODUCTION

The use of personal equipment protecting against falls from a height remains the only method of protection available for workers at many worksites, especially building sites and in the power industry [1]. As connecting elements, lanyards constitute a very important component of fall arrest systems. This component provides a link between an energy absorber attached to the anchorage point on worksite construction, and a full body harness designed for fall arrest [2].

The individual components of systems protecting against falls from a height are crucial in protecting workers at hazardous worksites. Their protective parameters directly influence the performance of systems which they form and, consequently, their users' health and life. For this reason, correct assessment of the protective parameters of lanyards and the use of appropriate, objective test methods is very important. For over 10 years, testing and

assessment of lanyards in the Member States of the European Union has been performed according to European standards [3, 4, 5]. However, it follows from the testing practice that the application of the methods and assessment criteria used to date have not always been suitable for newly developed products. In particular, this concerns low elongation lanyards. This paper, based on the results of work carried out in the Central Institute for Labour Protection – National Research Institute (CIOP-PIB) [6], concerns this problem and suggests new test methods for low elongation lanyards.

2. CONSTRUCTION OF LANYARDS

Lanyards, depending on their designation, may be constructed in various ways and may be made of various materials. All lanyards are equipped with terminations, in the form of connectors,

This publication has been prepared on the basis of the results of tasks carried out within the scope of the National Programme "Adaptation of Working Conditions in Poland to European Union Standards", partly supported—within the scope of state services—in 2002–2004 by the Ministry of Economy, Labour and Social Policy. The Central Institute for Labour Protection – National Research Institute was the Programme's main co-ordinator.

Correspondence and requests for offprints should be sent to Krzysztof Baszczyński, Central Institute for Labour Protection – National Research, ul. Wierzbowa 48, 90-133 Łódź, Poland. E-mail: <krbas@ciop.lodz.pl>.

which make it possible to connect them to other components of a fall protection system, e.g., a full body harness, an energy absorber, or an anchorage point at the worksite. Depending on the needs, the length of a lanyard can be fixed or adjustable. Length adjusters make reducing or increasing the length of a lanyard possible, thus allowing minimization of the free fall distance. In most cases, length adjusters consist of (a) the main body enclosing the lanyard; (b) a connector (or an element to which it can be connected), constituting one of the ends of the lanyard; and (c) a mobile lever pressed down to the lanyard, which, depending on its position, blocks it or allows its free movement. According to the requirements of the EN 354:2002 standard [4] the length of a lanyard together with an energy absorber cannot exceed 2 m. Figures 1 and 2 show examples of the construction of a lanyard.

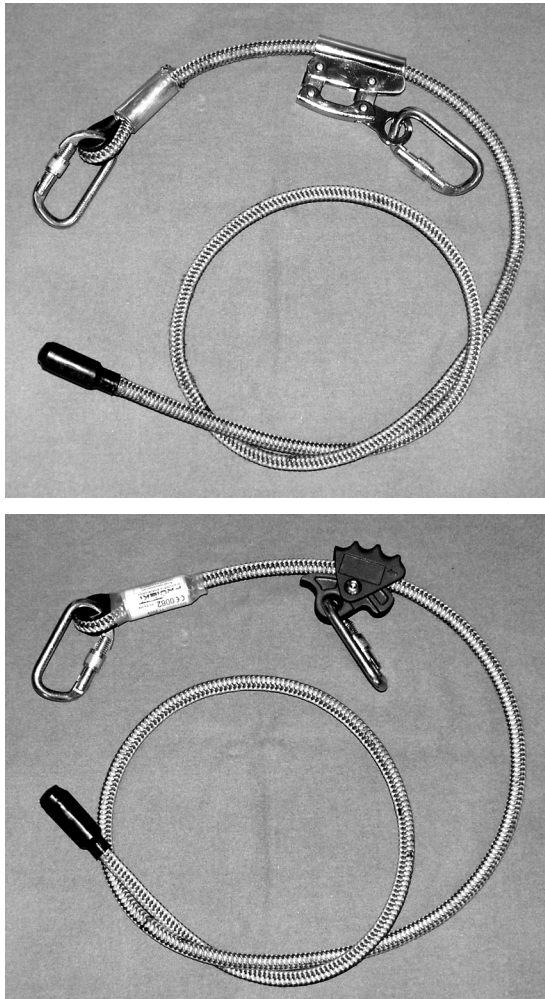

Figure 1. Lanyards made of steel wire rope with polyamide braid.

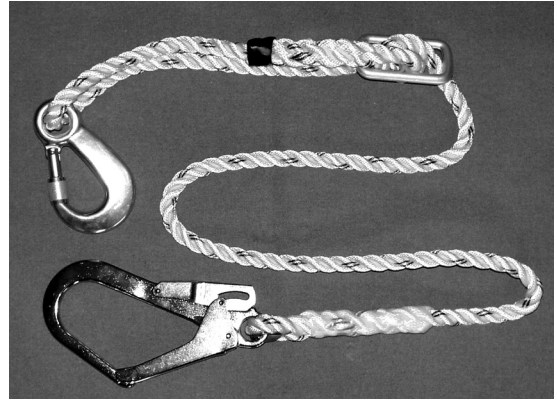

Figure 2. Lanyard made of a 14-mm diameter three-strand polyamide rope.

Lanyards used in systems protecting against falls from a height can be made of various materials, whose properties determine their specific usage. Polyamide and polyester ropes, which are characterized by appropriate dynamic and static strength and resistance to usage-related damage, are the most frequently used materials. Under actual usage conditions, however, there are specific situations which require the use of materials with special properties, e.g., resistance to the effect of high temperature or molten metal splash. In such cases, materials with appropriate properties, e.g., steel wire ropes, braided aramid ropes, or ropes with impregnated protective braids are used. The use of various materials (ropes and webbing) for the production of lanyards results in their varied resistance to the effect of environmental factors as well as in their different tension–elongation characteristics, determining the process of fall arrest. Examples of tension–elongation characteristics of ropes used for lanyard production are presented in Figure 3.

The diagram demonstrates clearly very significant differences in rope characteristics. As a result of such different characteristics, the ropes demonstrate varied capability of absorbing energy. The results of the calculation of energy (transformed into elongation) generated in a rope of the initial length of $L_0 = 2$ m a force of $F = 20$ kN are presented in Figure 4. The results were obtained using a numerical integration algorithm [7], utilizing approximated tension–elongation rope characteristics (Figure 3).

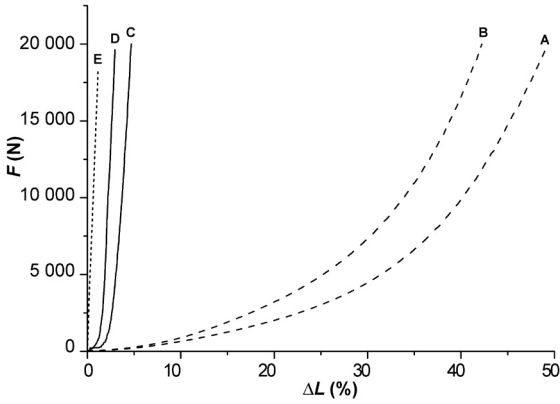

Figure 3. Examples of tension–elongation characteristics of ropes. Notes. A—14-mm diameter three-strand polyamide rope, B—18-mm diameter three-strand polyamide rope, C—10-mm diameter aramid rope, D—12-mm diameter aramid rope, E—8-mm diameter steel wire rope.

3. STATIC AND DYNAMIC STRENGTH—REQUIREMENTS AND TEST METHODS

When used, lanyards are exposed to the effects of numerous destructive factors, e.g., contact with sharp edges, aggressive chemicals and molten metal splash, which cause damage of the lanyard structure, thus reducing its protective properties. During fall arrest, in turn, the lanyard is subjected to dynamic forces which may reach the values of several thousand Newtons. Irrespective of the action of destructive factors, the lanyard must maintain the connection between the full body harness and the shock absorber, which are elements of the fall arresting system.

Such correct performance is warranted by compliance with the requirements specified in relevant standards. Resistance to static loads, determined by static strength tests, is the first essential requirement concerning lanyards. According to the requirements of European [4] and international [8] standards, a lanyard made exclusively of textile materials or textile elements of lanyards, should bear loading with a force of 22 kN acting for 3 min without disqualifying damage. Lanyards made of metal materials and their terminations, e.g., connectors should bear loading with a force of 15 kN acting for 3 min.

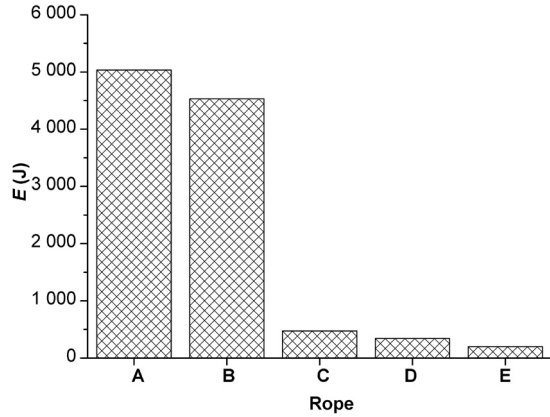

Figure 4. Energy (transformed into elongation) generating in a rope of the initial length of $L_0 = 2$ m a force of $F = 20$ kN. Notes. A—14-mm diameter three-strand polyamide rope, B—18-mm diameter three-strand polyamide rope, C—10-mm diameter aramid rope, D—12-mm diameter aramid rope, E—8-mm diameter steel wire rope.

A dynamic strength test performed in the case of adjustable lanyards is another essential test in which the protective properties of lanyards can be checked. The main objective of the test is to check the influence of the length adjuster, sliding along during fall arrest, on the lanyard.

Figure 5 presents sample results of dynamic strength tests of adjustable lanyards. Lanyards made of a three-strand polyamide rope equipped with a length adjuster (Figure 2) were tested. The diagram demonstrates that the initial position of the length adjuster on a lanyard influences the force acting along the lanyard during fall arrest. The tests proved that movements of a length adjuster can totally damage a lanyard (case c_{12} in Figure 5).

During the test a lanyard is loaded with a falling rigid test mass of presumed constant kinetic energy. European standards in this field [4, 5] require the test method presented in Figure 6 and explained as follows:

- set the lanyard length adjuster so as to obtain length equal to 60% of its maximum dimension;
- using a chain that complies with the requirements of the EN 364:1992 standard [5], increase the length of the lanyard to reach the value which would be obtained if the length adjuster were set at the maximum position;

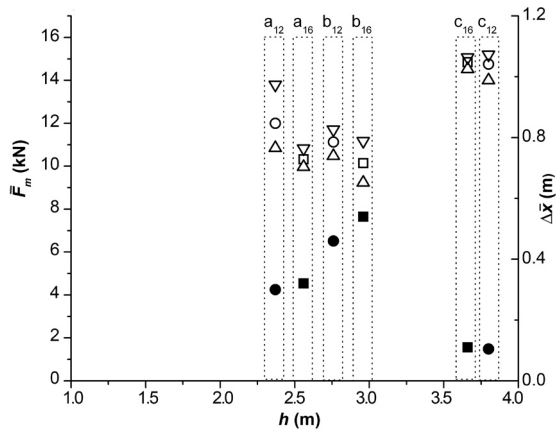

Figure 5. Test results of adjustable lanyards made of three-strand polyamide ropes. Notes. \circ \square —mean value of maximum values of force acting along lanyard during fall arrest (F_m), \triangle — $F_{m \min}$, ∇ — $F_{m \max}$, \bullet \blacksquare —mean value of displacement of length adjuster during fall arrest ($\Delta \bar{x}$), h —free fall distance of test mass of 100 kg, \circ \bullet —lanyard made of a 12-mm diameter rope, \square \blacksquare —lanyard made of a 16-mm diameter rope. Length of the lanyards as a result of position of length adjuster: a_{12} —1.18 m, b_{12} —1.4 m, c_{12} —2.0 m, a_{16} —1.12 m, b_{16} —1.35 m, c_{16} —2.0 m.

- connect the end of the lanyard prepared in this way to the rigid anchorage point meeting the requirements of the standard [5], and the other one to a rigid test mass of 100 kg;
- raise the rigid test mass so as to obtain a free fall distance of 4.0 (± 0.1) m, or, if the lanyard is shorter than 2 m, as high as allowed by the length of the lanyard;
- drop the rigid test mass observing whether the lanyard arrests its fall and what the damage of the lanyard is.

In the case of the international standard [8], the only difference in the test method concerns the way the lanyard is prepared: the length adjuster is set so as to obtain the length of the lanyard of 2.0 (± 0.025) m or, if this is impossible, the maximum length that can be obtained. Further testing procedure is consistent with the European standard [5].

The presented test methods involve the use of the same test conditions irrespective of lanyard construction and materials used for its production.

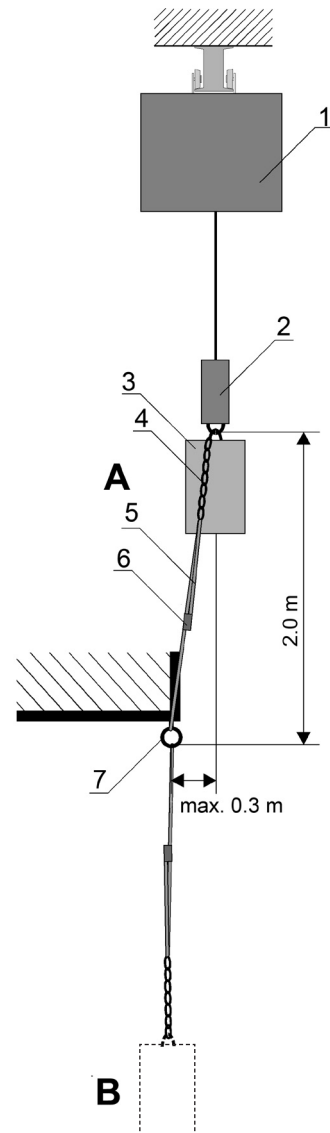

Figure 6. Dynamic strength test for lanyards (according to EN 364:1992) [5]. Notes. A—situation before the test, B—situation after fall arrest, 1—power winch for lifting and lowering test mass, 2—quick release device, 3—test mass of 100 kg, 4—chain, 5—lanyard, 6—length adjuster of a lanyard, 7—anchor point.

4. PERFORMANCE OF LANYARDS DURING FALL ARREST

A lanyard arresting the fall of people absorbs part of their kinetic energy. As a result of energy absorption, there is elastic and plastic elongation of the lanyard and force acting along the lanyard is generated. The maximum value of that force, F_m , depends on a series of factors. In the case of laboratory tests, the value of F_m is primarily dependent on factors presented in Figure 7.

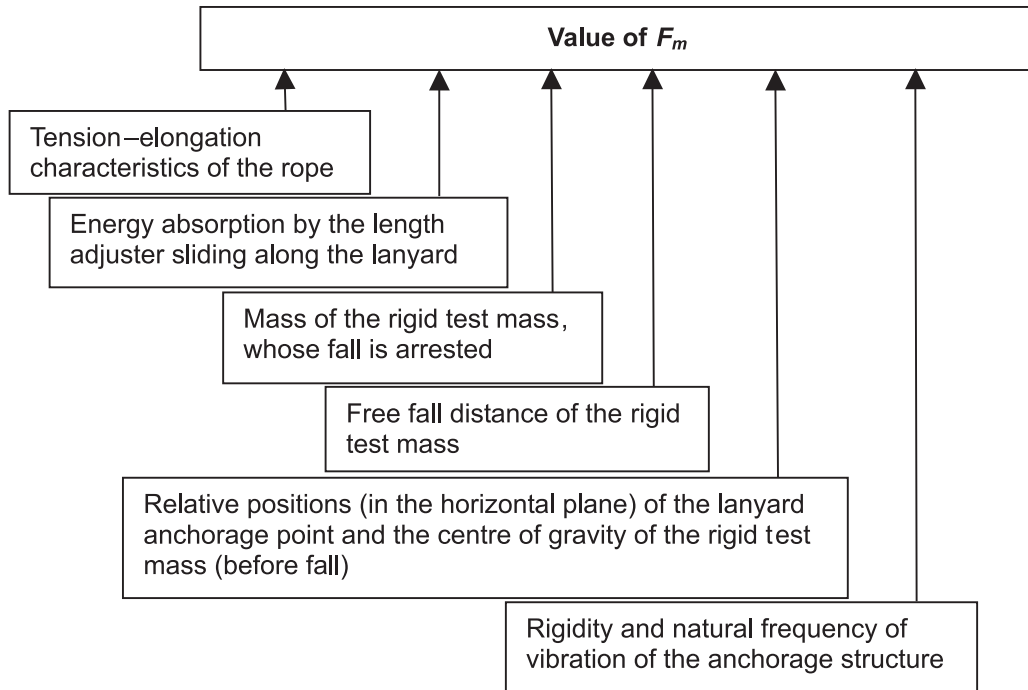

Figure 7. Factors influencing the maximum value of the force acting along the lanyard during fall arrest.

The first two of the listed factors are associated with the properties of a lanyard, whereas the other ones with the test stand and the test method.

The first phase of the study involved a numerical simulation of the performance of a lanyard during fall arrest. The idea of the simulation was to find correlation between the tension–elongation characteristics of lanyards and two parameters characterizing the fall arrest process: (a) the maximum value of the force acting on the anchorage point, and (b) displacement of the rigid test mass during the phase of fall arrest (equal to the maximum elongation of the lanyard).

In order to carry out the calculations the following assumptions were made:

- the dynamic load is applied to the lanyard by means of a falling rigid test mass of 100 kg;
- the ideally rigid anchorage point is situated in the perpendicular axis passing through the centre of gravity of the rigid mass;
- the calculations are carried out on the basis of Equation 1, which expresses the relation between the potential energy of the rigid test mass and the energy transformed into lanyard elongation,

$$mgh + mgH_m = \int_0^{H_m} F(s) ds, \quad (1)$$

where g —acceleration of gravity, s —displacement of the rigid test mass (lanyard elongation), $F(s)$ —tension–elongation characteristics of the lanyard, m —mass of the rigid test mass, h —free fall distance of the rigid test mass, H_m —distance of the rigid test mass fall arrest (maximum value of elongation);

- no displacement of the length adjuster takes place during fall arrest;
- the tension–elongation characteristics of lanyards are independent of loading velocity [9, 10].

The calculations based on Equation 1 were performed using a program in Pascal [11], specially developed for this purpose. Equation 1 utilized the analytic form (obtained by approximation) of the tension–elongation characteristics presented in Figure 3 and a numerical integration algorithm [7]. The calculations were carried out with the following parameters: $L_0 = 2.0$ m (initial length of the lanyard) and $m = 100$ kg. The results of the calculations are presented in Figure 8.

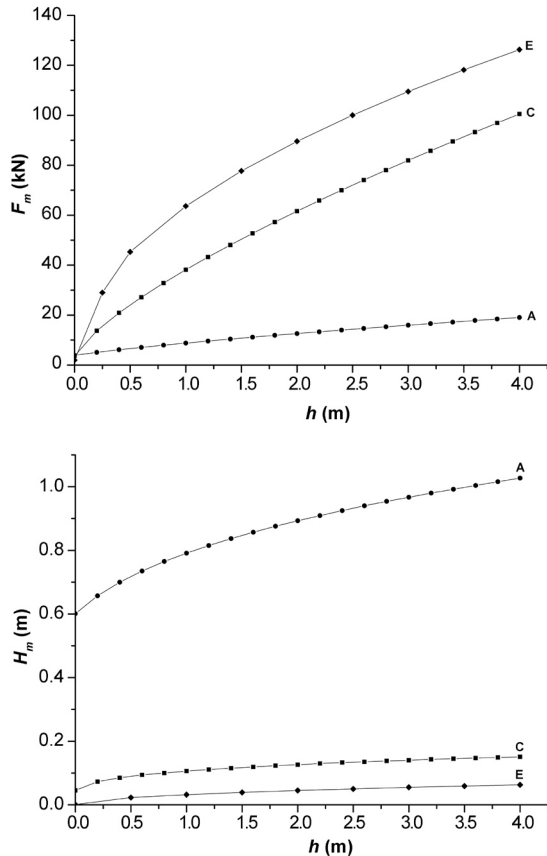

Figure 8. The results of a numerical simulation. Notes. F_m —maximum value of the force acting on the end of a lanyard, H_m —maximum value of the elongation of a lanyard; A—14-mm diameter three-strand polyamide rope, C—10-mm diameter aramid rope, E—8-mm diameter steel wire rope.

The diagrams demonstrate clearly that the maximum values of force F_m and elongation H_m are strongly correlated with the tension–elongation characteristics of lanyards. In the case of lanyards made of high elongation materials (a three-strand polyamide rope marked A), the values of force F_m are a few times lower than in the case of aramid and steel wire ropes. For elongation values H_m the situation is exactly the opposite, because they are the highest for the polyamide rope. Thus, the numerical simulation demonstrates that application of a constant kinetic energy value of the falling rigid test mass during dynamic strength tests results in extremely different loads of the lanyards made of various materials.

The next stage of the research involved an analysis of the performance of real lanyards

during fall arrest. For lanyards made of polyamide and polyester ropes the analysis was based on the results of Baszczyński, Kamańczyk, Korycki, et al.'s and Sulowski's studies [12, 13]. For lanyards made of low elongation materials, own laboratory tests were performed. Adjustable lanyards made of (a) 8-mm steel wire rope, with polyamide braid; and (b) 12-mm aramid rope, with cotton braid, were tested.

The maximum length of the tested lanyards was 2 m, and their terminations were equipped with connectors that complied with the requirements of the European standard [14]. Two types of length adjusters (Figure 1) were applied.

Figure 9 presents the most significant example of the obtained relation between the maximum value of the F_m force acting at the anchorage point and the value of the free fall distance h of a rigid test mass of $m = 100$ kg. In the case of lanyards made of aramid rope, the length adjuster was pre-set in such a position that the length of the lanyard was equal to 60% of its maximum length. The length adjusters of steel wire rope lanyards were set in an extreme position, so that the lanyards were 2 m long. The points presented in the diagram are the means of four tests.

In those tests, the free fall distance was increased progressively until there was serious damage to the length adjusters or connectors, leading to the release of the falling rigid test mass. Examples of the observed damage are presented in Figure 10.

The results of the numerical simulation and laboratory tests evidently demonstrate differences between the performance of lanyards made of materials whose elongation is high (polyamide and polyester ropes) and low (aramid and wire steel ropes) during dynamic loads. The differences are particularly important in the case of permanent blocking of the length adjuster on the lanyard or its initial placement near the termination of the lanyard. It was observed that if such a condition was fulfilled, the following phenomena became evident as the lanyard elongation decreased: (a) an increase of the maximum value of the F_m force acting at the anchorage point, and (b) a decrease of the maximum value of lanyard elongation H_m .

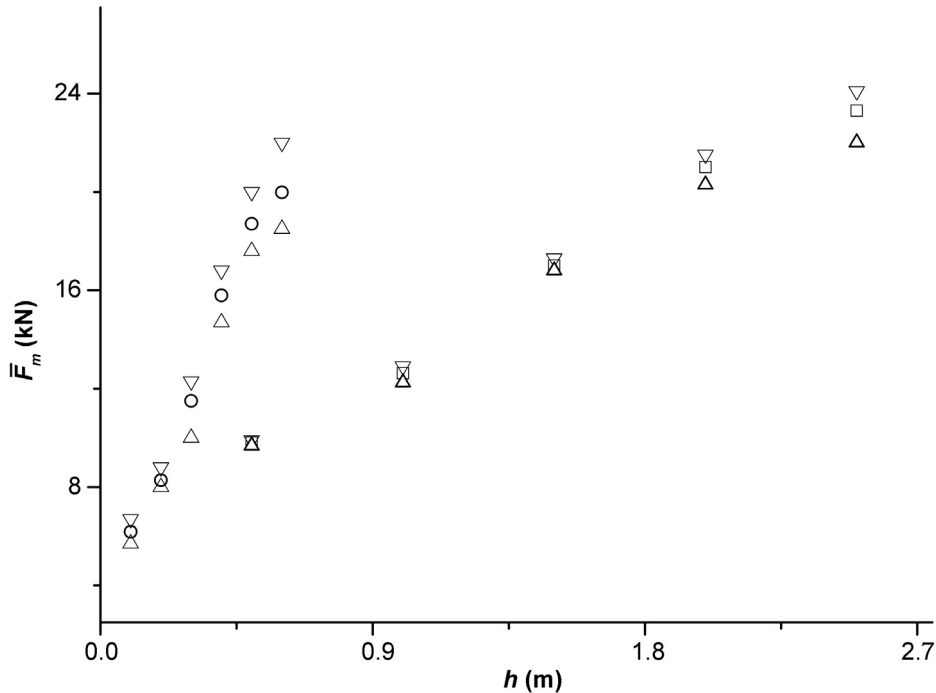

Figure 9. Test results of adjustable lanyards. Notes. ○— \bar{F}_m for lanyards made of steel wire rope with polyamide braid, □— \bar{F}_m for lanyards made of aramid rope, △— $F_{m \min}$, ▽— $F_{m \max}$.

As a result of those phenomena, very serious damage to length adjusters, connectors and ropes was observed in tests of low elongation lanyards. In some cases, the damage to the elements led to a release of the rigid test mass. It is also important that such effects occur even if the free fall distance of the test mass is equal to about 50% of the required height specified in the standards [5, 8].

5. CONCLUSIONS

The results presented in this paper indicate that several objections to the dynamic strength tests of lanyards specified in the European and international standards [3, 4, 8] should be raised.

- Imposing constant distance of a free fall of a rigid test mass results in considerably different values of dynamic forces acting on lanyards made of various materials.
- The values of forces acting on lanyards under test conditions are not logically related to the values of forces occurring under actual conditions of a fall arrest. The lanyards used in systems designed for fall arrest, compliant

with the requirements of the EN 363:2002 standard [2], are always connected in a series with an energy absorber [15]. This results in a reduction of the force to values not exceeding 6 kN. Thus, there is no justification for using over four-fold higher force values in laboratory tests.

- During the tests of dynamic strength of low elongation lanyards, there are situations in which the acting force reaches higher values than those required in static strength tests. Then, e.g., a connector compliant with the EN 362:1992 standard [2] (bearing, under static conditions, loading with a force of 15 kN) breaks under dynamic conditions because the force acting on it in this situation reaches 25 kN.

As a result of the usage of the test methods just presented, protective equipment may be disqualified, despite the fact that its properties pose no risk to the user's health or life.

Summing up the presented arguments, it seems feasible to take steps aimed at modification of the presented requirements and methodology of dynamic strength tests for lanyards equipped with length adjusters. Such modification could be based on several essential assumptions.

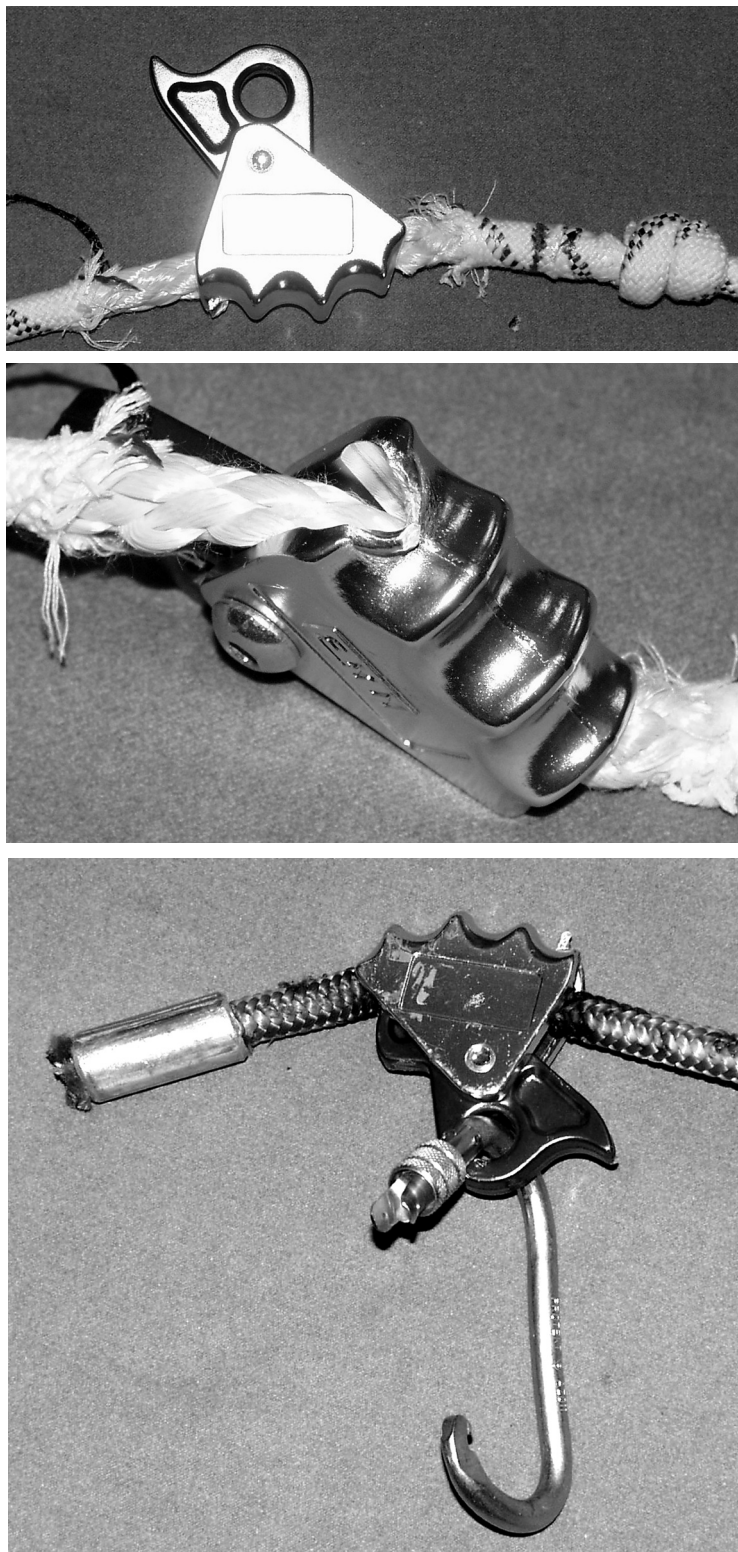

Figure 10. Examples of damage to ropes, length adjusters and connectors.

- The force acting at the anchorage point is an additional parameter defining the conditions of dynamic strength tests of lanyards.
- Measurements of the force acting at the anchorage point are performed with measuring equipment consistent with the requirements

of the EN 364:1992 standard [5] (designed for determination of the maximum value of braking force of energy absorbers under dynamic conditions).

- Lanyards should be prepared for dynamic strength tests according to the method described in the EN 354:2002 standard [4] (length of the lanyard should be adjusted to 60% of its full length; a chain should be attached to the lanyard so that the overall length of lanyard and chain is equal to the maximum length of lanyard).
- The distance of a free fall of a rigid test mass of 100 kg (loading the lanyard) should be high enough to allow the following requirements concerning the force acting at the lanyard anchorage point to be met: (a) 15 (± 0.5) kN for a lanyard made exclusively of metal elements; and (b) 22 (± 0.5) kN for a lanyard made of textile elements or containing such elements; or, if that is impossible, (c) the free fall distance should equal double the maximum length of the tested lanyard.
- An appropriate height for a free fall of a rigid weight can be selected for a particular construction experimentally, e.g., with an incremental increase method.

Application of the presented assumptions will make it possible to improve the requirements and test methods for lanyards, which is critical for the evaluation of new constructions.

REFERENCES

1. Sulowski AC. Fall arresting systems—selection of equipment. In: Sulowski AC, editor. *Fundamentals of fall protection*. Toronto, Ont., Canada: International Society for Fall Protection; 1991. p. 303–20.
2. European Committee for Standardization (CEN). *Personal protective equipment against falls from a height—fall arrest systems* (Standard No. EN 363:2002). Brussels, Belgium: CEN; 2002.
3. European Committee for Standardization (CEN). *Personal protective equipment against falls from a height—lanyards* (Standard No. EN 354:1992). Brussels, Belgium: CEN; 1992.
4. European Committee for Standardization (CEN). *Personal protective equipment against falls from a height—lanyards* (Standard No. EN 354:2002). Brussels, Belgium: CEN; 2002.
5. European Committee for Standardization (CEN). *Personal protective equipment against falls from a height—test methods* (Standard No. EN 364:1992). Brussels, Belgium: CEN; 1992.
6. Baszczyński K, Jabłońska A, Zrobek Z. *Opracowanie i wdrożenie procedur badań linek bezpieczeństwa stosowanych w sprzęcie chroniącym przed upadkiem z wysokości*. [Preparation and bringing into practice test procedures for lanyards protecting against falls from a height] [unpublished report]. Warszawa, Poland: Central Institute for Labour Protection – National Research Institute; 2004.
7. Björck Å, Dahlquist G. *Metody numeryczne* [Numerical methods]. Warszawa, Poland: PWN; 1987.
8. International Organization for Standardization (ISO). *Personal fall-arrest systems—part 2: lanyards and energy absorbers* (Standard No. ISO 10333-2:2000). Geneva, Switzerland: ISO; 2000.
9. Miura N, Sulowski AC. Introduction to horizontal lifelines. In: Sulowski AC, editor. *Fundamentals of fall protection*. Toronto, Ont., Canada: International Society for Fall Protection. 1991. p. 217–83.
10. Baszczyński K, Zrobek Z. Dynamic performance of horizontal flexible anchor lines during fall arrest—a numerical method of simulation. *International Journal of Occupational Safety and Ergonomics (JOSE)*. 2000;6(4):521–34.
11. Borland International. *Borland® Pascal with objects. Language guide 7.0*. Scotts Valley, CA, USA: Author; 1992.
12. Baszczyński K, Kamańczyk P, Korycki R, Zrobek Z. *Badania wydłużeń statycznych i dynamicznych podzespołów łącząco-amortyzujących występujących podczas powstrzymywania spadania* [Tests of static and dynamic elongations of equipment during fall arrest] [unpublished report].

- Warszawa, Poland: Central Institute for Labour Protection; 1996.
13. Sulowski AC. Assessment of maximum arrest force in fall arresting systems. In: Sulowski AC, editor. *Fundamentals of fall protection*. Toronto, Ont., Canada: International Society for Fall Protection; 1991. p. 165–92.
 14. European Committee for Standardization (CEN). *Personal protective equipment against falls from a height—connectors* (Standard No. EN 362:1992). Brussels, Belgium: CEN; 1992.
 15. European Committee for Standardization (CEN). *Personal protective equipment against falls from a height—energy absorbers* (Standard No. EN 355:2002). Brussels, Belgium: CEN; 2002.