



ARCHIVES
of
FOUNDRY ENGINEERING

ISSN (2299-2944)
Volume 18
Issue 2/2018

146 – 150

DOI: 10.24425/122518

26/2



Published quarterly as the organ of the Foundry Commission of the Polish Academy of Sciences

Identification of Structural Components of Turbine Engine Flap After Modification of Casting Technology Parameters

A. Remišová^{a,*}, A. Sládek^a, J. Belan^b

^aDepartment of Technological Engineering, University of Zilina, Univerzitna 1, 010 26 Zilina, Slovakia

^bDepartment of Materials Engineering, University of Zilina, Univerzitna 1, 010 26 Zilina, Slovakia

* Corresponding author. E-mail address: anna.remisova@fstroj.uniza.sk

Received 06.03.2018; accepted in revised form 04.06.2018

Abstract

First part of the article describes how we can by change of gating system achieve better homogeneity of product made by investment casting. Turbine engine flap was made by investment casting technology – lost wax casting. The casting process was realised in vacuum. The initial conditions (with critical occurrence of porosity) was simulated in ProCAST software. Numerical simulation can clarify during analysis of melt turbulent flow in gate system responsible for creation of entrained oxide films. After initial results and conclusions, the new gating system was created with subsequent turbulence analysis. The new design of gating system support direct flow of metal and a decrease of porosity values in observed areas was achieved. Samples taken from a casting produced with use of newly designed gating system was processed and prepared for metallography. The second part of article deals with identification of structural components in used alloy - Inconel 718. The Ni – base superalloys, which are combined unique physical and mechanical properties, are used in aircraft industry for production of aero engine most stressed parts, as are turbine blades.

Keywords: Turbine engine flap, Investment casting, Inconel 718

1. Introduction

Aerospace industry is one of the biggest consumers of advanced materials, because of its unique combination of mechanical, physical properties and chemical stability. High alloyed stainless steel, titanium alloys and nickel base superalloys are most used for aerospace applications. High alloyed stainless steel is used for shafts of aero engine turbine, titanium alloys for compressor blades and finally nickel base superalloys are used for most stressed parts of jet engine – turbine blades. Turbine blades are commonly produced by investment casting process. By investment casting technology is possible to produce components with complex shapes and high accuracy. This technology belongs

to “near-net-shape” technologies, what means that a lot of functional areas are created during the casting process with final quality and we don’t need to apply finishing operations. This technology is used mainly in aircraft industry, because of complex shape of produced parts, good mechanical properties and possibility to process super alloys.

One of progressive tools used to analyze whole casting process, including melt flow, turbulence occurrence, hot spots and also internal defects is numerical simulation. During experiments was used software ProCAST developed by company ESI group. ProCAST is able to simulate complex data from whole casting process with high accuracy and find defects in individual part of the process. [3]

2. Description of turbine engine flap

Evaluated casting is a flap used in turbine engines, commonly produced by investment casting technology. Casting in the initial state had a problem with porosity, this condition was unacceptable for the customer. The flap is one of the section in anti surging valve (Fig.1), which is part of turbine engine Trent 7000.

At the moment when the air flow is disturbed by the engine, the so-called “surge” occurs, which results in a reduction of the absolute velocity of the air flow and the change of the air flow angle on the blades. This causes the overpressure to occur in front of the compressor and not behind it, as a result of which the engine loses its thrust. Rapid acceleration or deceleration of engine speed is causing an imbalance which has a negative effect on his life cycle. The simplest construction way to prevent this phenomenon is application of anti-surging valves that open when the pressure reaches critical values, and after the pressure equalization process is done, the flaps return to the original position.

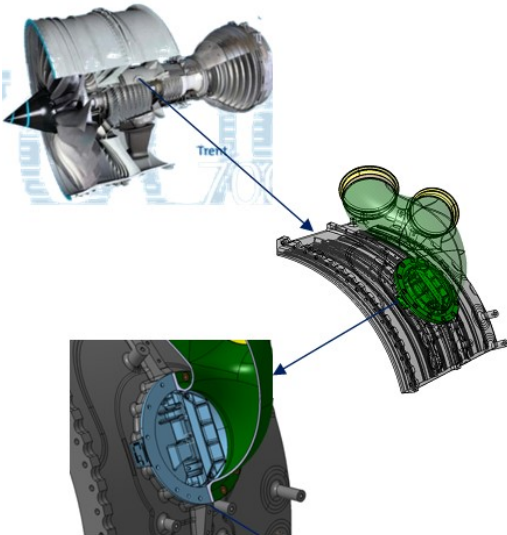

Fig. 1. Position of anti - surge valve in turbine engine

2.1 Critical parts of flap

Analysed areas are located at the sections A-A and B-B shown on figure 2.

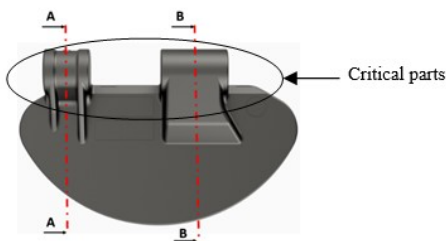

Fig. 2. Cut sections

The first design of castings resulted to formation of internal porosity at the points of flap maximum force load. In area A-A, the pore area represents 1.23% of given area. The porosity detected at the cut B-B was 3.04 %.

This places are critical from the force load point of view, and occurrence of porosity is very detrimental to the stress rupture and fatigue properties. Measured values of porosity were supercritical for the customer so gating system optimization was necessary to lower the porosity values. [2]

3. Simulation analysis

The initial position was simulated in casting software ProCAST (Fig. 3a). Character of the mold filling can influence the final quality of casts, because it was found that there was turbulent flow pattern in gating system. It has been shown that the melt in the mold cavity is circulating in individual parts of gating system and raising turbulent character of filling is shown in figure 3b. Colour spectrum represents the individual line of flow.

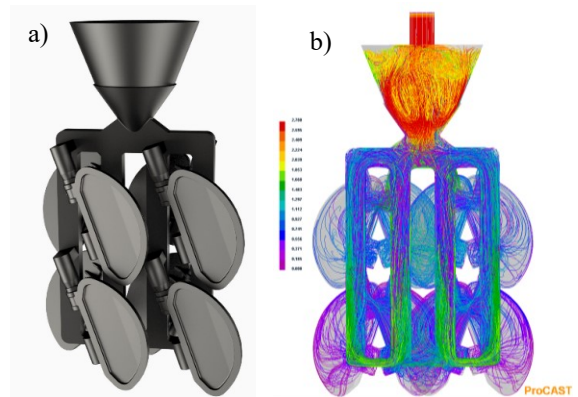

Fig. 3. a) Initial position of system, b) Result of turbulent analysis

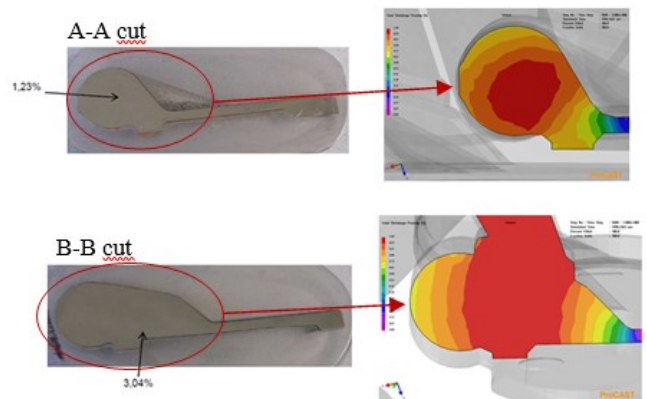

Fig. 4. Evaluation of porosity in critical areas

The result of porosity analysis (Fig.4) confirm the porosity occurrence exceeding critical values. Assumption is, that such filling character has negative effect on the resulting porosity, therefore design change of gating system was necessary. The

change also involved the application of wraps which were located on the thin parts of the component to affect solidification character and also to secure the directional solidification (Fig. 5a). After that a turbulence analysis was performed. New result showing more acceptable flow of metal without excessive turbulences (Fig. 5b) and a decrease in porosity values in evaluated areas (Fig. 6). Newly designed system support the melt to fill the cavity without circulating up and down in gating system.

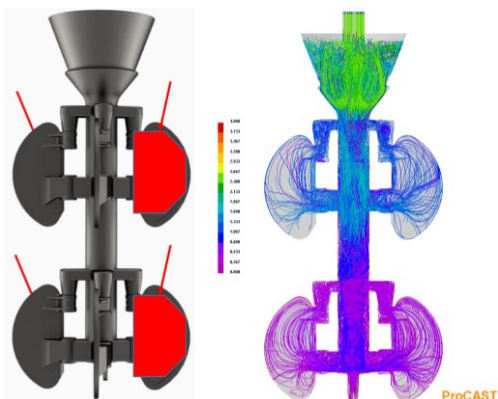

Fig. 5. a) New design of gating system b) Result of turbulence analysis

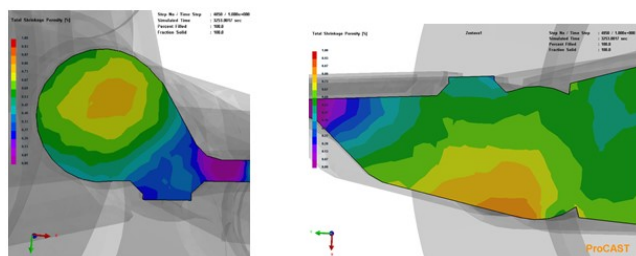

Fig. 6. Evaluation of porosity analysis for a new gating system, (left-A-A cut, right -B-B cut)

The figure 7 shows a porosity in critical parts of flap casting evaluated on light microscope in cut A-A, before the changes (left) and after the optimization (right).

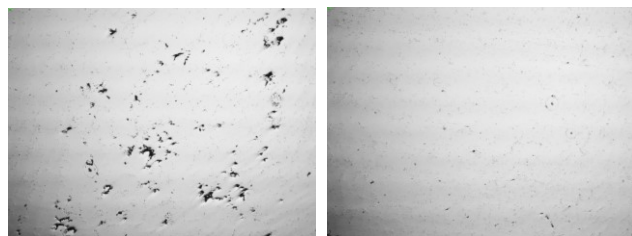

Fig. 7. Cut A-A, evaluation of porosity – Initial design (left), new design (right)

The figure 8 shows a porosity in critical parts of flap casting in cut B-B before the changes (left) and after the optimization (right).

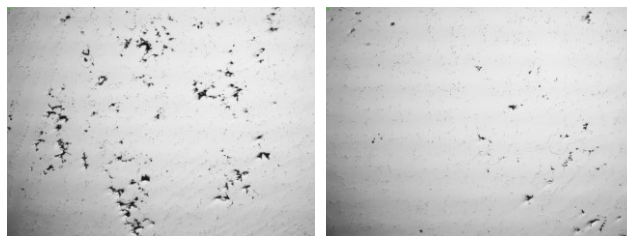

Fig. 8. Cut B-B – evaluation of porosity – Initial design (left), new design (right)

4. Material of the flap

The turbine engine flap is made of material Inconel 718, which is material assign between super alloys of nickel. This kind of material have ability to retain high strength, even after long thermal exposure above the 650°C, which is the limit point use of heat-resistant steels. Material combine high strength and ductility with excellent surface stability. [1]

4.1 Chemical composition

The main alloying elements in nickel super alloys can be classify to:

- chrome – Cr dissolved in the γ -phase and it is a basic element that increases the refractoriness of alloy
- cobalt – increases creep resistance, increases recrystallization temperature, stabilizes MC carbides and improves forming
- aluminium & titanium – allowing hardenability of nickel super alloys – intermetallic precipitate $Ni_3(Al, Ti)$
- molybdenum & wolfram – hardening of the matrix and create carbides, which increasing creep resistance

The same effect like Co have also Fe, however Fe has negative influence to refractoriness and causes inclination to brittleness (creation of δ phase). Similar effect like Al and Ti has niobium. Chemical composition of Inconel 718 which was used to produce the turbine engine flap is shown in Tab.1. [1,5]

Table 1
Chemical composition of flap material

	Al	B	C	Co	Cr	Cu	Mn
Min.%	0.4	0	0	0	17	0	0
Max.%	0.8	0.006	0.08	1	21	0.3	0.35
Real.%	0.45	0.003	0.048	0.3	18.67	0.01	0.02
	Mo	Nb	Ni	P	S	Si	Ti
Min.%	2.8	4.75	50	0	0	0	0.65
Max.%	3.3	5.5	55	0.015	0.015	0.35	1.15
Real.%	3.01	4.97	53	0.004	0.001	0.07	1.02

Amount of iron can be considered as residual between 11.15 wt.% up to 24.4 wt. %.

4.2 Structure of Inconel 718

Inconel 718 contains a lot of alloying elements therefore microstructure of casted nickel super alloy is chemically inhomogeneous. Dendritic segregation in nickel-base super-alloys is a side effect of solidification. Dendritic segregation is shown in the figure 9. As said above, two phenomena can affect super alloys properties, inhomogeneity of the microstructure and phase instability (precipitation of topologically closed packed phases). Figure 9 represents part of cut A-A for the first type of gating system. These figures are created by differential interference contrast microscope. The same sample, but taken from improved gating system design is shown in figure 10. Because experimental material is very hard, all of the samples had to pre-etched for 15seconds by Marble and after then was fine-etched for approximately 25 seconds by Kallings2. [5,6]

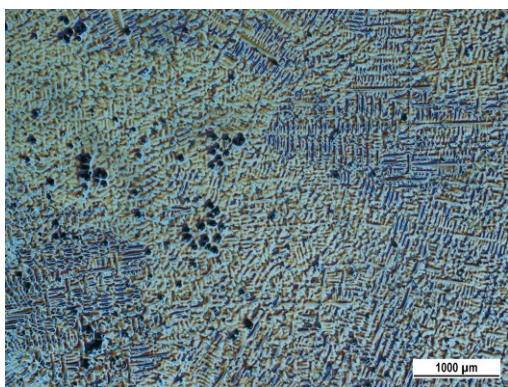

Fig. 9. Dendrite segregation, cut A-A (DIK-25x) – initial gating system design

Figure 10 presents that microstructure appears to be coarsened (because the wraps application changed cooling rate) and that the porosity is lower (because of better melt flow character and better filling ability thanks to wrap prolonged solidification interval).

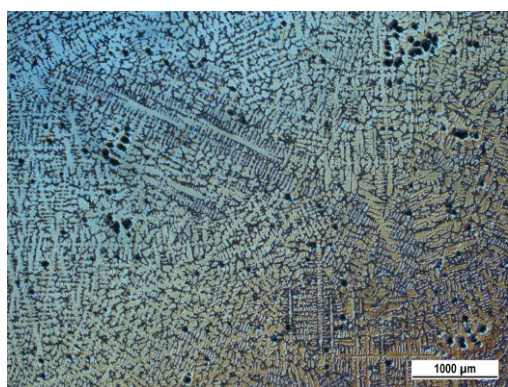

Fig. 10. Dendrite segregation, cut A-A (DIK-25x) – improved gating system design and wraps

The basic part of microstructure in casting state is γ phase, i.e. solid solution additive in nickel, which have face-centered cubic lattice (K12). The arrangement of the matrix is provided by carbides and γ' / γ'' phase. Phase γ' is intermetallic compound

$\text{Ni}_3\text{Al}(\text{Ti})$ with coherent face-centered cubic lattice (L1₂) like γ phase. Phase γ'' is reinforcing phase with body-centered tetragonal lattice. Another phase occurring in evaluated material is δ phase (Ni_3Nb) with orthorhombic lattice. This phase looks like a needle-shaped form visible (see Fig. 11). Figure was taken from cut A-A – initial state of gating system. Figure 12 presents the same place, but second - optimized type of gating system. By using optimized gating system the δ phase is more subtle, but the shape does not change. We can assume that due to the wraps, this phase has a greater solubility then during the variant without wraps. [5,6]



Fig. 11. Needle-shape of δ phase – 1. Cut A-A (mag. 800x)

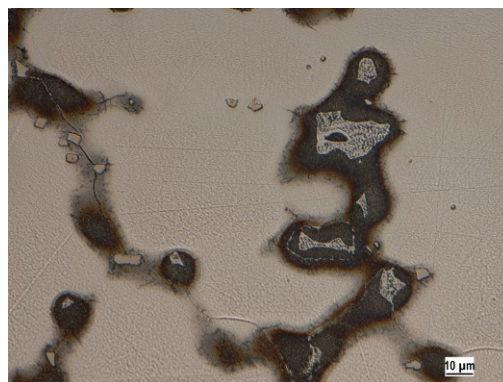

Fig. 12. Cut A-A from second type of gating system (mag. 800x)

Figures 11 and 12 presents a carbide, which occur as cluster in interdendritic section. These carbides can be identified as MC (NbC, TiC) – appearing as primary carbides. This carbides are formed mainly because of presence of Ti. Mo and W are partially dissolving. The cluster (discontinuous) microstructure of this carbides are important for toughness of alloy. [5,6]

5. Conclusions

The paper shows that by the optimization of gating system we can achieve better quality of casting from porosity point of view, also by application of wraps at critical places, we can achieve better filling conditions and change the phase appearance in the microstructure, which can change the final properties of the casting.

Also, numerical simulation software can be considered as a powerful tool during gating system optimization process and can be helpful during the whole technological process of casting preparation.

References

- [1] Skočovský, P., Palček, P., Konečná, R., Várkony, V. (2000). *Construction materials*. Žilina: EDIS. (in Slovak).
- [2] Adamec, J., Kokáb, J. (2008). *Aircraft engines*. Praha: Corona spol. s. r. o.. (in Czech).
- [3] Herman, A. (2009). *Casting on a removable model*. Retrieved January, 2018, from <http://docplayer.cz/419638-Ing-ales-herman-ph-d.html>. (in Czech).
- [4] Brůna, M., Richtárek, L. & Bolibruchová, D. (2015). Influence of nickel addition on properties of secondary AlSi7MgO alloy. *Archives of Foundry Engineering*. 15(2), 95-98.
- [5] Belan, J. (2009). Influence of cooling rate on γ' morphology in cast Ni – base superalloy. *Archives of Foundry Engineering*. 9(2), 101-104.
- [6] Copley, S.M., Kear, B.H. (1967). Structural characteristics of super alloys, part I. *The Minerals, Metals & Materials Society – The American Institute of Mining, Metallurgical, and Petroleum Engineers* 239, pp. 977-983.
- [7] Konar, R. & Mician, M. (2017). Ultrasonic inspection techniques possibilities for centrifugal cast copper. *Archives of Foundry Engineering*. 18(2), 35-38.