

<https://doi.org/10.32056/KOMAG2021.4.4>

Research on the use of hydro-pneumatic accumulators in order to reduce the flow rate and pressure pulsations of oscillating hydraulic intensifiers

Received: 21.09.2021

Accepted: 26.11.2021

Published online: 29.12.2021

Author's affiliations and addresses:

¹ National Institute of Research & Development for Optoelectronics / INOE 2000-subsiary Hydraulics and Pneumatics Research Institute –IHP Bucharest, Romania

* Correspondence:

e-mail: popescu.ihp@fluidas.ro

Alexandru-Polifron CHIRIȚĂ ¹, **Teodor-Costinel POPESCU** ^{1*}, **Ana-Maria Carla POPESCU** ¹, **Radu-Șerban DINCĂ** ¹, **Alexandru-Daniel MARINESCU** ¹

Abstract:

Oscillating hydraulic pressure intensifiers, of the minibooster type, are supplied at the inlet, in the primary, by low-pressure pumps and provide, at the outlet, in the secondary, high pressure to the hydraulic consumers (linear or rotary hydraulic motors under load). The pressure increase in the secondary, proportional to the amplification factor of the intensifier occurs at a much lower flow rate than the supply flow rate, and thus the two hydraulic parameters (pressure and flow rate) at the outlet of the intensifier are affected by oscillations. Because of this, the miniboosters are designed for static applications, which require low displacements of hydraulic motors. The authors aimed to expand the field of use of miniboosters by reducing the flow rate and pressure pulses with the help of hydro-pneumatic accumulators mounted on the primary and secondary of the intensifiers. If these pulsations can be mitigated, then low-pressure pump units of small dimensions, equipped with miniboosters, can be used in dynamic mining-specific applications, in complete safety, such as, for example, those involving relatively uniform displacement, under load, of some hydraulic jacks. A numerical simulation model developed in Simcenter Amesim highlights the effect of using hydro-pneumatic accumulators on the mitigation of flow rate and pressure pulsations of the oscillating hydraulic intensifiers. Numerical simulations performed with and without hydro-pneumatic accumulators mounted on the primary and secondary of the intensifier highlight the following aspects:

- hydro-pneumatic accumulators can be used successfully for the partial damping of flow rate and pressure pulses, but they must be dimensioned for each specific application and work optimally for a relatively narrow pressure range;
- using hydro-pneumatic accumulators can sufficiently improve the uniformity of displacement and the velocity of displacement of a hydraulic cylinder, so that it can be used in less demanding dynamic applications, as well.

Keywords: minibooster, numerical simulation, high-pressure, flow rate and pressure pulsations, hydro-pneumatic accumulators



1. Introduction

Hydraulic pressure amplifiers with oscillating pistons [1-9] are known in the literature under several names: oscillating hydraulic pressure amplifiers, oscillating pumping units, pressure intensifiers, boosters, miniboosters (miniBOOSTER Hydraulics).

The oscillating hydraulic pressure intensifier (OHPI) is used to generate higher pressure using a low-pressure hydraulic power source. Considering the high-pressure flow pulses, OHPIs can be single acting, SAOHPI (higher pulsations; they pump on a single direction of piston movement) or double acting, DAOHPI (lower pulsations; they pump on both directions of piston movement).

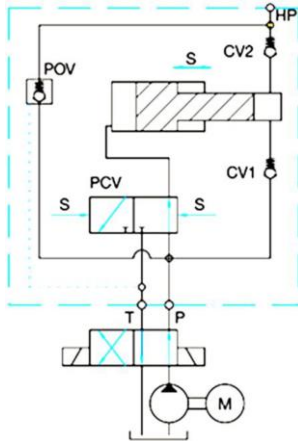

Fig. 1. Structure and operation of the SAOHPI: operating principle [11]

The basic structure of an SAOHPI:

- **assembly of two pistons** of different diameters, connected by a rod;
- **PCV**= piston control valve (bistable piston distribution valve);
- **CV1, CV2**= check valves;
- **POV**= pilot operated check valve;
- **P, T** = ports for consumers of a 4/2 directional control valve;
- **M** = drive motor of a hydraulic pump with fixed flow rate and low pressure.

The position of the pistons will determine, at the end of each stroke, a signal **S** to the **PCV**, which will cause a change in the direction of piston travel. This "pulsating" cycle of piston movement, with a maximum frequency of 20 Hz [10], lasts until the end pressure is reached, after which the piston stops. Onwards, they will only move to maintain the end pressure at **HP** port.

The operating principle of an SAOHPI (Fig. 1) is as follows: a large fluid volume and low pressure pushes a large diameter piston, which is in contact with another piston, of small diameter; as an effect of this action, the small diameter piston will push a small volume of fluid, with high pressure, **HP**, equal to the low pressure, **LP**, amplified by the ratio of piston surfaces. The high pressure, **HP**, will always be proportional to the supply pressure of the large piston [12, 13].

The authors aimed to expand the field of use of miniboosters, reducing the flow rate and pressure pulses with the help of hydro-pneumatic accumulators mounted on the primary and secondary of the intensifiers; in this regard, they set the following objectives:

- identification of flow rate and / or pressure pulses caused by the way an oscillating pressure intensifier works;
- quantitative and qualitative measurement of flow rate and pressure pulses; their influence on the operation of a hydraulic cylinder connected in the secondary of the oscillating pressure intensifier;
- quantitative and qualitative measurement of the pressure pulses from the primary of the intensifier, where the low-pressure hydraulic pump is connected;
- taking constructive measures to reduce flow rate pulses and / or pressure pulses and presenting the effect of these measures.

The four mentioned objectives will be achieved in two work stages of an applied research project, namely:

- **numerical simulation** of the dynamic behavior for a hydraulic supply system containing a low pressure pump group, which feeds the primary of a minibooster and a hydraulic cylinder, which is fed from the secondary of the minibooster [14];
- **experimental identification** of the numerical simulation model, on an equivalent test stand, which will be developed under the project [15-20].

In order to fulfill the previously presented objectives and because, at this point, the development of the stand has not been completed yet, so it is not possible to perform physical experiments in the laboratory, *this article only deals with issues related to the first stage* (numerical simulation).

2. Materials and Methods

Both the numerical simulation model and the equivalent test stand on which it will be identified experimentally have been / will be developed for a dynamic application using an HC7 minibooster, respectively a hydraulic supply system composed of: a low-pressure pumping group; a Hydraulics A / S minibooster: HC7-5.0-B-12, whose primary is fed by the pumping group; a hydraulic cylinder, which is fed from the secondary of the minibooster and moves a load over the entire stroke.

This article partially presents the results of numerical simulations; on request, all the results obtained from running the numerical simulation model in Fig. 2, and the graphs corresponding to the texts written in “italics”, from chapter 3 can be delivered.

2.1. Presentation of the numerical simulation model

On the numerical simulation model in Fig. 2, developed using the Simcenter AMESim software, both the constructive measures taken to reduce the pulsations and their effect will be virtually tested. In this sense, the simulation model comprises two hydro-pneumatic accumulators and two 2/2 directional control valves, with electric control, which connect / disconnect the accumulators to / from the hydraulic pumping system and the hydraulic cylinder, to present on the same graph the differences between the two situations studied.

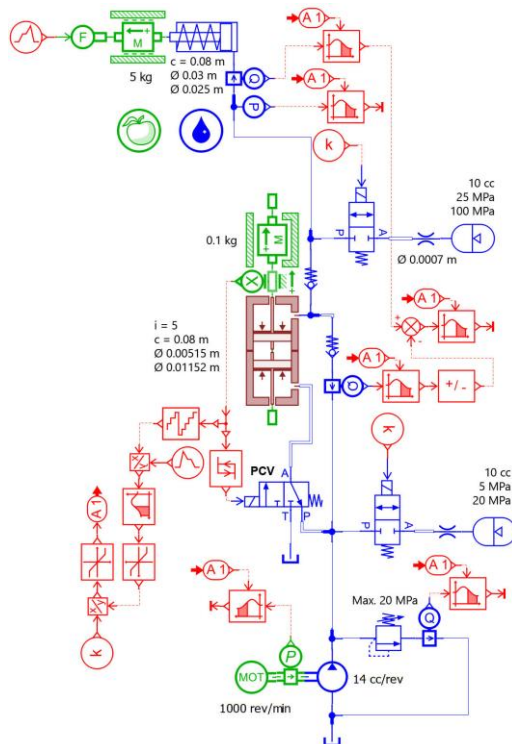

The structure and initial data of the numerical simulation model

The oscillating hydraulic intensifier:

- amplification ratio = 5/1; the two diameters of the pistons: $5.15 \times 10^{-3} \text{ m}$ and $11.52 \times 10^{-3} \text{ m}$; total mass of the pistons = $100 \times 10^{-3} \text{ Kg}$; the maximum pressure: in the primary = max. 20 MPa; in the secondary max. 100 MPa.

PCV is also part of the intensifier.

The electric motor: rotation speed = 1000 rev/min.

The hydraulic pump with gears:

- capacity = $14 \times 10^{-6} \text{ m}^3/\text{rev}$.

The pressure valve: acting as a safety valve; set at 20 MPa; natural frequency of 68 Hz.

The 2 hydraulic accumulators: - volume = $10 \times 10^{-6} \text{ m}^3$;
- the initial pressure: in the primary = 5...20 MPa; in the secondary = 25...100 MPa; natural frequency of 14 Hz.

The hydraulic cylinder:

- stroke = $80 \times 10^{-3} \text{ m}$;

- diameter of the piston = $30 \times 10^{-3} \text{ m}$;

- diameter of the rod = $25 \times 10^{-3} \text{ m}$.

The 2/2 directional control valves.

Fig. 2. Numerical simulation network

The numerical simulation model in Fig. 2 also embeds other initial data, namely: other blocks with various functions, various measurements, signal processing (moving average) and calculation of pumping frequency; hydraulic oil HEP46; - sampling rate 1000 Hz, 3001 points, simulation time 3 s, a tolerance of 1×10^{-7} . The numerical simulation aims to highlight the influence of the intensifier on the hydraulic system. In order not to influence the results presented, the pump, the directional control valves and the hydraulic cylinder have no volume losses and have an ideal behavior, as well as in the case of the two chambers of the intensifier, which if they do not have flow losses, represent the most unfavorable situation in terms of pressure and flow rate pulses. The components with real behavior are: the hydraulic pipes take into account the compressibility of the fluid, flow resistance created by surface roughness and the inertia of the fluid column; the gas cushion of the hydro-pneumatic accumulators has a real gas behavior and the one-stage safety valve has a dynamic behavior

(2nd order system), as well as the two directional control valves. The oil used is HEP46 with extreme pressure additive.

2.2. Mode of operation for simulation model; brief description

The electric motor drives the hydraulic pump with a constant rotational speed (Fig. 2). This one supplies, alternately, constant flow in the primary and the secondary of the intensifier, with the help of the PCV directional valve; due to the ratio of the areas of the two chambers of the intensifier, the pressure is **amplified 5 times**.

The two check valves are connected in the secondary of the intensifier; their role is to prevent high pressure from reaching the pump.

In the secondary of the intensifier the single acting hydraulic cylinder is also connected. On this numerical simulation model, the 2/2 directional control valves have the role of disconnecting the two hydraulic accumulators, in order to show **the differences in the operation of the hydraulic system, with the hydraulic accumulators connected or disconnected**.

Because on the experimental test stand the intensifier is connected directly to the hydraulic cylinder port, only the check valve and a direct hydraulic connection are interposed between the volume of the secondary of the intensifier and the dead volume of the hydraulic cylinder, without having an additional volume of fluid to influence the results of the simulation.

3. Results

For the identification and quantitative and qualitative measurement of flow rate and / or pressure pulses, as well as their influence (effect) on the operation of the hydraulic cylinder, initially four simulations were performed: a) the first of them did not have any accumulator connected; b) the second had only one accumulator connected to the secondary of the intensifier; c) the third had an accumulator connected to the primary of the intensifier; d) the fourth had both accumulators connected.

After performing the four simulations mentioned above, it was found that:

- connecting an accumulator to the primary of the intensifier does not bring any benefit in the primary or secondary;
- *connecting an accumulator in the secondary of the intensifier visibly improves the uniformity of the flow and pressure only at the hydraulic cylinder port;*
- ***by connecting one accumulator in the primary and one in the secondary***, the amplitude of the pressure pulsations in the primary decreases, and the uniformity of the flow and pressure in the secondary improves considerably compared to the previously mentioned case, in which only one accumulator was connected in the secondary.

Taking into account the above observations and in order to make the results presented as clear and easy to compare as possible, the following graphs show ***in red the results of the simulation without accumulators*** and ***in blue the results of the simulation with two accumulators***, one in the primary, and the other one in the secondary.

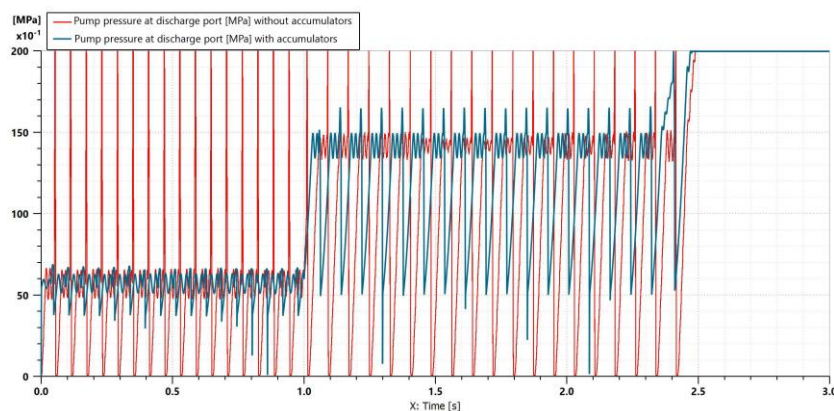

Fig. 3. Variation of the pressure at the discharge port of the hydraulic pump over time

Fig. 3 shows the pressure at the discharge port of the pump. It can be seen that the accumulator helps reduce the amplitude of the pressure pulses and tends to even out the resistant torque. On the inactive stroke of the intensifier, without accumulators the pressure reached 20 MPa, and with accumulators, the maximum pressure in the primary reaches the value of 16 MPa.

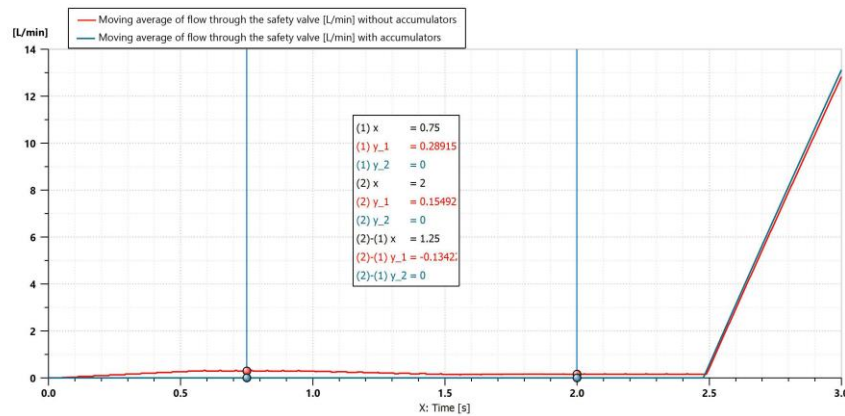

Fig. 4. Moving average of flow rate through the safety valve

The advantage of maintaining a pressure with a value of less than **20 MPa** in the primary is that in the case of using accumulators, the safety valve no longer discharges (on average) the 0.2 l/min (Fig. 4) at a pressure of 20 MPa with a frequency of pulsations of approximately 25 Hz. Eliminating these frequent discharges prolongs the service life of the safety valve. The safety valve is not the only component in the primary of the intensifier that is affected by pressure variations, pulsations caused by the way the intensifier works; another such component is the pump. It is considerably shortened in service life if it is repeatedly subjected to large pressure variations. When pressure variations have large amplitudes and their value reaches zero, they tend to destroy the pump housing relatively quickly, due to the phenomenon of fatigue of the housing material and noise.

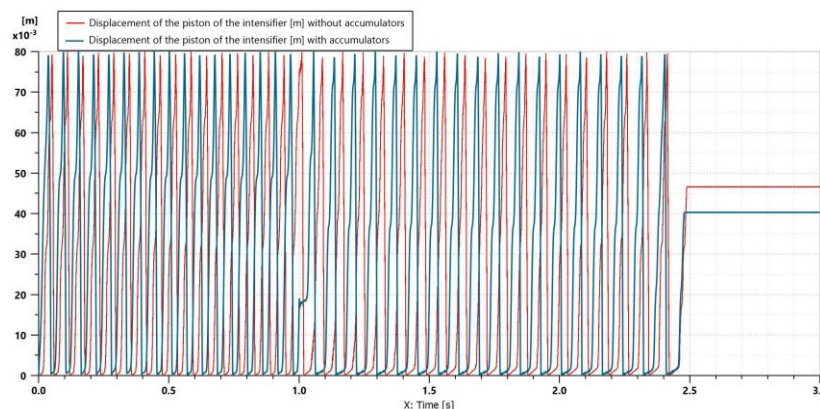

Fig. 5. Variation of the stroke of the hydraulic oscillator (intensifier's piston) over time

Fig. 5 shows the variation of the hydraulic oscillator stroke over time, in the two studied cases: it can be seen that the system with accumulators reacts late to the sudden increase of the load; in the second case, around second 1 of simulation, the appearance of a linear distribution around 18 mm value (blue curve) with a duration of 0.03 s can be noticed. The appearance of this linear distribution is caused by the sudden increase of the load in the secondary of the intensifier; this downtime occurs due to the elasticity of the primary.

Another aspect worth mentioning is the fact that, usually, hydraulic systems containing accumulators have a delayed response, which on the graph in question, for relatively small loads, does not seem to be true; in fact, only in this case, as it can be seen in Fig. 6, the pumping frequency for the simulation with accumulators increases slightly, because the pressure in the primary is less than

20 MPa, and part of the flow rate of the gear pump is no longer lost through the safety valve, as in the case of accumulator-free simulation.

In Fig. 6, it can be seen how the pumping frequency of the intensifier is affected by the load in the secondary and the flow rate lost through the safety valve in the primary.

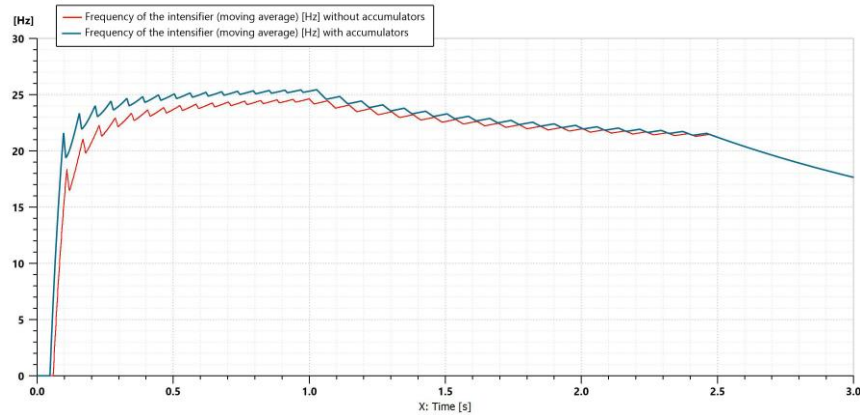

Fig. 6. Variation of the moving average frequency of the hydraulic oscillator (intensifier piston) over time

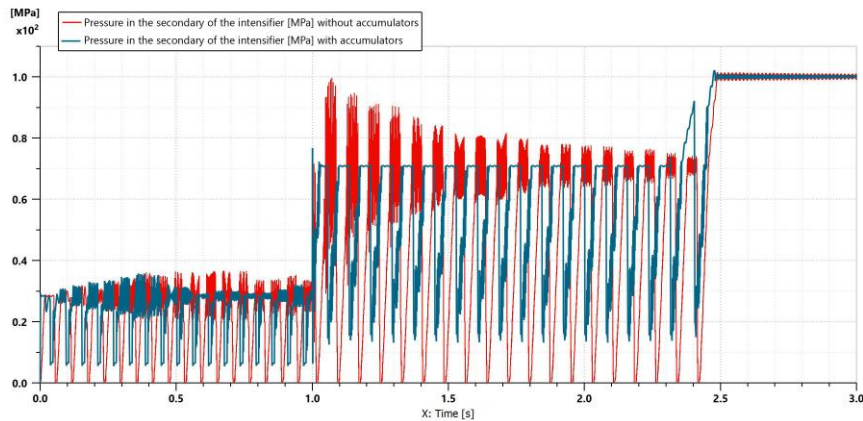

Fig. 7. Variation of the pressure in the secondary of the intensifier over time

The variation of the pressure in the secondary of the intensifier over time is shown in Fig. 7. It can be seen how the hydraulic accumulator "cuts" the pressure peaks, which can reach 100 MPa, when a relatively large load suddenly appears on the secondary of the intensifier. Also on this graph, one can see that, when using accumulators, the pressure does not reach very low values.

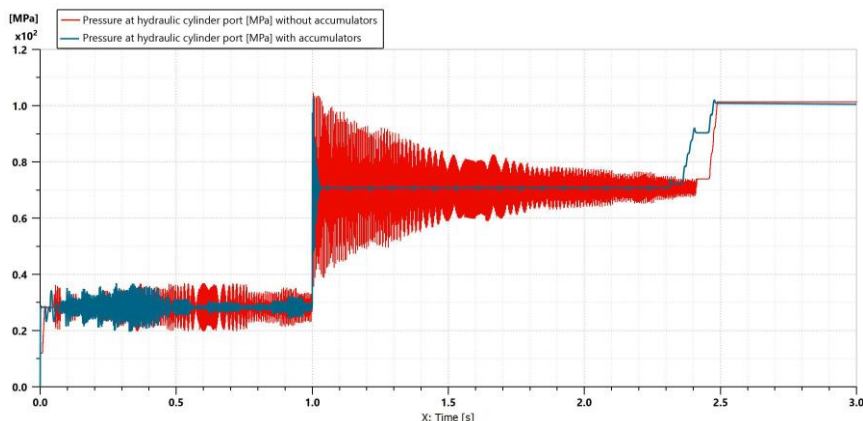

Fig. 8. Variation of the pressure at the port of hydraulic cylinder over time

Fig. 8 shows the variation of the pressure at the hydraulic cylinder port over time. The hydraulic accumulators reduce the amplitude of the pressure pulsations in the secondary, with average values between 20 MPa and 30 MPa, at a maximum of 1.6 MPa, around 70 MPa for which the two hydraulic accumulators were dimensioned.

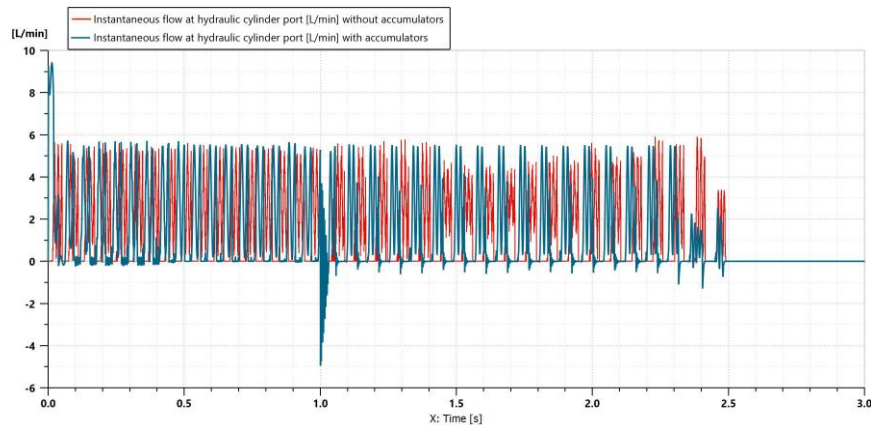

Fig. 9. Variation of the instantaneous flow rate at the hydraulic cylinder port over time

Fig. 9 shows the time variation of the instantaneous flow rate at the port of the hydraulic cylinder. At the beginning of the simulation, for a very short period of 0.02 s, almost all the pump flow bypasses the intensifier and pressurizes the hydraulic cylinder, until the pressure in the secondary increases sufficiently and the intensifier begins to amplify the pressure, sending to the cylinder an instantaneous flow of maximum 6 l/min.

From the results of the numerical simulation, it can also be observed:

The influence that the sudden application of a large load has on the flow rate, the accumulator compensating for this shock;

How the hydraulic accumulator helps even out flow; it does not perfectly equalize the flow because the volume of the accumulator is not large enough. If the volume of the accumulator is increased from $10 \times 10^{-6} \text{ m}^3$ to $12 \times 10^{-6} \text{ m}^3$ or a higher value, the hydraulic cylinder reaches a considerably decreased flow due to the elasticity of the accumulator;

On the moving average of the pressure in the hydraulic cylinder, three linear distributions can be noticed; two of them are created by the load on the rod of the hydraulic cylinder, and the last one occurs because the hydraulic cylinder reaches the end of the stroke.

Fig. 10 shows the variation of the moving flow rate average at the hydraulic cylinder port over time. On this graph, one can see that the intensifier discharges a flow rate between 1.5 and 2 l/min, depending on the pumping frequency, performed at relatively low pressures, and when the pressure increases, the pumping frequency decreases simultaneously with the flow, having an average value of 1.28 l/min for high pressures.

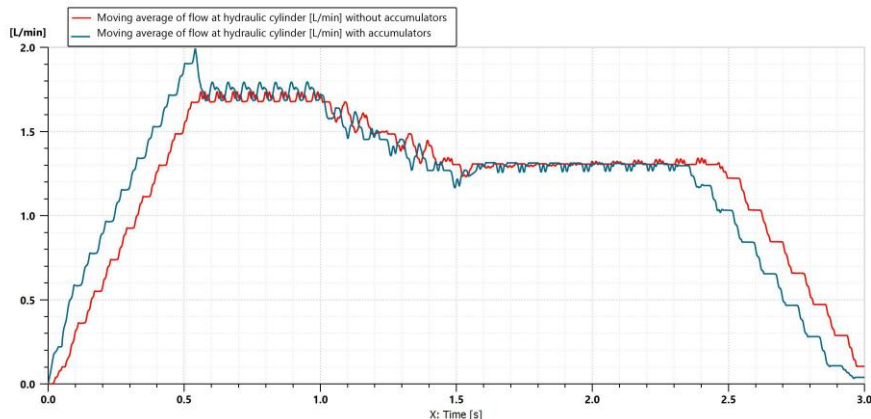

Fig. 10. Variation of the moving flow rate average at the hydraulic cylinder port over time

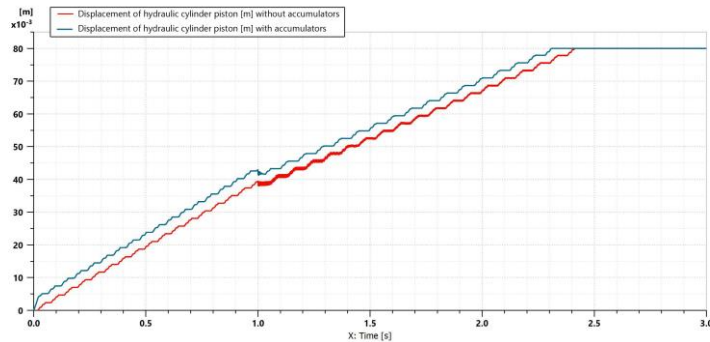

Fig. 11. Variation of the displacement of the hydraulic cylinder piston over time

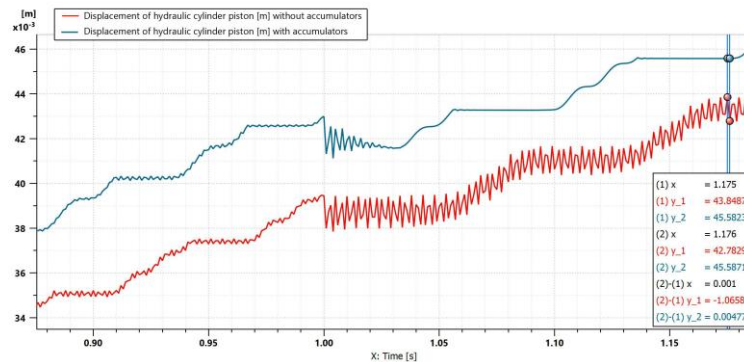

Fig. 12. Detail: displacement of the piston of the hydraulic cylinder

Fig. 11 and 12 show the time variation of the displacement of the hydraulic cylinder piston. On them, one can notice that the accumulator helps even out the displacement of the piston of the hydraulic cylinder, in the case of loads that produce values of pressures of approx. 70 MPa, in which case the accumulator in the secondary of the intensifier was chosen and charged with nitrogen.

On the detail in Fig. 12, one can see that the vibration with an average amplitude of 1.07 mm, which corresponds to a pressure of 70 MPa, is considerably reduced, in the case of using hydraulic accumulators, to a value with an amplitude of 0.0048 mm. A visible reduction of the vibration amplitude can also be observed for the pressure of 30 MPa, this effect being a secondary one; so the accumulator helps with damping for this pressure as well, but the damping is not optimal.

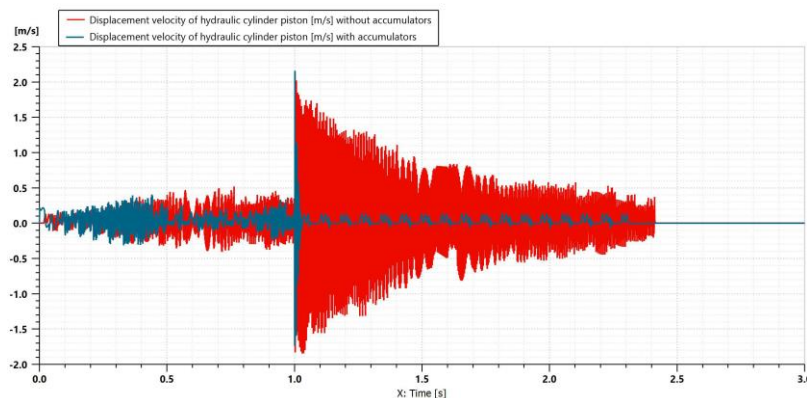

Fig. 13. Variation in time of the speed of movement of the hydraulic cylinder piston

Fig. 13 shows the variation of the speed of the hydraulic cylinder piston over time. One can easily notice the influence of the hydraulic oscillator on the speed of movement of the hydraulic cylinder rod, and how these speed variations are considerably reduced, if the load has values of 70 MPa and the two accumulators are connected.

The numerical simulation also shows:

- the amplitude of the speed variation was measured, in case of using hydraulic accumulators. This variation has a maximum value of 0.2 m/s, and without accumulators, the average value is 2 m/s, for pressure values of 70 MPa. Visible damping also occurs for the pressure of 20 MPa;
- the acceleration of the piston of the hydraulic cylinder. The accumulators restrict by a few orders of magnitude the variation of the amplitude of the acceleration;
- the force produced by the hydraulic cylinder piston and the force that opposes the displacement of the hydraulic cylinder piston;
- the force produced by the piston of the hydraulic cylinder. For the working pressure of 70 MPa; the average amplitude of the force variation is 20000 N, this variation being reduced to a maximum value of 1277 N.

4. Discussion

Lack of public information about several constructive - functional characteristics of the miniboosters (piston diameters, oscillation strokes / frequencies of the piston assembly and the PCV, the size of the clearance between the moving parts and the bores in which they move, the flow to the primary output port of intensifier) requires obtaining them, by direct or indirect measurements, in the experimental identification on the stand, followed by adjustment of the numerical simulation model (experimental validation of the simulation model). This is the direction for the continuation and completion of this research.

5. Conclusions

Hydraulic accumulators can be used successfully for the partial damping of flow and pressure pulses, but they must be dimensioned for each specific application and work optimally for a relatively narrow pressure range. In order to ensure the effective operation of the accumulator, as a pressure pulsation filter for a frequency of 15 to 25 Hz (intensifier frequency average range), the natural frequency of the accumulator must be close to the lower limit of the above range, and the frequency of accumulators used is 14 Hz.

Using suitable hydraulic accumulators can sufficiently improve the uniformity of movement and travel speed of a hydraulic cylinder, so that it can be used in less demanding dynamic applications. The pressure pulsations in the intensifier's primary, those that reach the hydraulic gear pump, were also reduced due to the accumulator in the intensifier's primary; the shocks produced by the load in the secondary of the intensifier no longer reach the hydraulic pump, being compensated by the accumulator.

Acknowledgments

The research presented in this paper has been developed and funded under Financial Agreement no. 272/24.06.2020, signed by the Ministry of European Funds / Ministry of Education and Research and S.C. HESPER S.A. Bucharest for the Innovative Technological Project titled "Digital mechatronic systems for generating pressure of 1000 bar, using hydraulic pressure intensifiers" (SMGP), which is under implementation from 01.07.2020 to 30.06.2023. The authors of the paper are researchers from INOE 2000-IHP Bucharest, SMGP project partner. European funding has also been granted, under Competitiveness Operational Programme POC 2014-2020, call POC-A1-A.1.1.3-H-2016, Financial agreement no. 253/02.06.2020, signed between INOE 2000 and the Ministry of Education and Research for the project titled "Horizon 2020 Support Center for European project management and European promotion PREPARE", MYSMIS2014 code 107874.

References

- [1] Yongchao X., Jinyan S.: The Design of a comparative amplifier for deep sea. Advances in Engineering Research 2018 (8th International Conference on Manufacturing Science and Engineering (ICMSE 2018)), vol. 164, pp. 493-496, ISBN: 978-1-5108-6418-4
- [2] Wang F., Gu L., Chen Y.: A hydraulic pressure-boost system based on high-speed On Off valves. IEEE/ASME Trans. Mechatronics 2013, vol. 18, no. 2, pp. 733-743, DOI: 10.1109/TMECH.2011.2182654



- [3] Zwier M. P., vanGerner H. J., Wits W.W.: Modelling and experimental investigation of a thermally driven self-oscillating pump. *Applied Thermal Engineering* 2017, vol. 126, pp. 1126-1133, DOI: 10.1016/j.applthermaleng.2017.02.063
- [4] Khandekar S., Dollinger N., Groll M.: Understanding operational regimes of closed loop pulsating heat pipes: an experimental study. *Applied Thermal Engineering* 2003, vol. 23, no. 6, pp. 707-719, DOI: 10.1016/S1359-4311(02)00237-5
- [5] Fuqiang C., Rendong W., Chaolong Y., Wei W., Wei J.: Research on Velocity Fluctuation of High Pressure and High Flow Double Booster Cylinder Hydraulic System. *Hindawi Mathematical Problems in Engineering*, vol. 2020, Article ID 2648508, DOI: 10.1155/2020/2648508
- [6] Dobson R.T.: Theoretical and experimental modelling of an open oscillatory heat pipe including gravity. *International Journal of Thermal Sciences* 2004, vol. 43, no. 2, pp. 113-119, DOI: 10.1016/j.ijthermalsci.2003.05.003
- [7] Yang F., Tadano K., Li G., Kagawa T.: Analysis of the Energy Efficiency of a Pneumatic Booster Regulator with Energy Recovery. *Applied Sciences* 2017, vol. 7, no. 8, paper ID 816, DOI:10.3390/app7080816
- [8] Nazarov F., Rakova E., Weber J., Vardini A.R.: A Novel Approach for Pneumatic Pressure Booster. In: *Proceedings of 11th International Fluid Power Conference 11. IFK*, vol. 3, pp. 222-235, DOI: 10.18154/RWTH-2018-224786
- [9] Levinsen A.: Scanwill fluid power Unique hydraulic pressure intensifier solutions. https://www.luvra-hydraulik.de/fileadmin/web_data/downloads/Luvra-Hydraulik-Scanwill-0915.pdf [accessed: 13.09.2021]
- [10] Gannon M.: How can hydraulic pressure intensifiers improve your system design? <https://www.fluidpowerworld.com/can-hydraulic-pressure-intensifiers-improve-system-design/> [accessed: 11.09.2021]
- [11] <https://www.scanwill.com/files/documents/Scanwill-productsheet-en.pdf> [accessed: 11.09.2021]
- [12] Espersen C.: Pressure Boosters in Hydraulic Systems A Solution Which Is Often Overlooked. https://nanopdf.com/download/pressure-boosters-in-hydraulic-systems_pdf [accessed: 13.09.2021]
- [13] Pioneer Machine Tools, Inc.: The increase pressure actuation system of hydraulic boosters HC series. <http://www.pmt-pioneer.com/en/product-detail5.html> [accessed: 13.09.2021]
- [14] <https://www.minibooster.com/hc7/> [accessed: 13.09.2021]
- [15] Zardin B., Cillo G., Zavadinka P., Hanusovsky J., Borghi M.: Design and modelling of a cartridge pressure amplifier. In: *Proceedings of the ASME/JSME/KSME Joint Fluids Engineering Conference 2019*, vol. 1, article no. UNSP V001T01A043, DOI: 10.1115/AJKFluids2019-5474
- [16] Bartnicki A., Klimek A.: The research of hydraulic pressure intensifier for use in electric drive system. *IEEE Access* 2019, vol. 7, pp. 20172-77, DOI 10.1109/ACCESS.2019.2897148
- [17] Zardin B., Cillo G., Borghi M., Zavadinka P., Hanusovsky J.: Modelling and simulation of a cartridge pressure amplifier. In: *Proceedings of the ASME-BATH Symposium on Fluid Power and Motion Control 2018*, article no. V001T01A057
- [18] Popescu T.C., Chirita A.P., Popescu A.I.: Increasing energy efficiency and flow rate regularity in facilities, machinery and equipment provided with high operating pressure and low flow rate hydraulic systems. In: *Proceedings of 18th International Multidisciplinary Scientific GeoConference SGEM 2018*, vol. 18, pp. 401-408, DOI: 10.5593/sgem2018/4.1
- [19] Popescu T.C., Chiriță A.P., Popescu A.M.C.: Research on the assessment of flow and pressure pulses in oscillating hydraulic intensifiers. *Mining Machines* 2020, No. 4 (164), pp. 14-23, DOI: 10.32056/KOMAG2020.4.2
- [20] Günaydın A.C., Halkacı M., Ateş F., Halkacı H.S.: Experimental Research of the Usability on Double Acting Intensifiers in Hydroforming. In: *Proceedings of the MATEC Web of Conferences 220 ICMSC 2018*, 04001 (2018), https://www.matec-conferences.org/articles/mateconf/pdf/2018/79/mateconf_icmsc2018_04006.pdf [accessed:13.09.2021]