

ROBUST MODEL PREDICTIVE CONTROL FOR AUTONOMOUS UNDERWATER VEHICLE – MANIPULATOR SYSTEM WITH FUZZY COMPENSATOR

Hossein Nejatbakhsh Esfahani

Gdansk University of Technology, Poland

ABSTRACT

This paper proposes an improved Model Predictive Control (MPC) approach including a fuzzy compensator in order to track desired trajectories of autonomous Underwater Vehicle Manipulator Systems (UVMS). The tracking performance can be affected by robot dynamical model uncertainties and applied external disturbances. Nevertheless, the MPC as a known proficient nonlinear control approach should be improved by the uncertainty estimator and disturbance compensator particularly in high nonlinear circumstances such as underwater environment in which operation of the UVMS is extremely impressed by added nonlinear terms to its model. In this research, a new methodology is proposed to promote robustness virtue of MPC that is done by designing a fuzzy compensator based on the uncertainty and disturbance estimation in order to reduce or even omit undesired effects of these perturbations. The proposed control design is compared with conventional MPC control approach to confirm the superiority of the proposed approach in terms of robustness against uncertainties, guaranteed stability and precision.

Keywords: UVMS, Model Predictive Control, Fuzzy Compensator

INTRODUCTION

Nowadays, engaging the underwater autonomous mobile platforms has been adopted by various operators and industries in order to explore underwater environment, accomplish inspections of undersea structures using non-destructive tests, detect damage revealed inside of the nuclear reactor containment and kinds of other works which are limited by the rigorous circumstances of an unknown environment. The two main parts of an autonomous system are navigation and control which recently striking researches have been presented in [15,16,17] applied to the marine navigation area such as optimized path planning and collision avoidance strategies. Regarding the control part of an underwater

autonomous platform, due to the high nonlinear terms of the Underwater Vehicle-Manipulator System (UVMS) dynamics, some robust control strategies were used or contributed by the researchers as high-performance control approaches against all the uncertainties and external disturbances. The hydro-static and hydro-dynamic uncertainties discovered during underwater manipulator movement are comprised of the added mass, added Coriolis, buoyancy force, drag force and frictional forces. As a common robust approach, the Sliding Mode Controller (SMC) has been chiefly applied for controlling the robotic systems under uncertainties and nonlinear parameters [1, 2]. Nevertheless, beside of the robustness attribute in SMC, the actuator flaws and finally decreasing of the control performance, particularly

for trajectory tracking goals, has been brought about by the chattering phenomenon. As literature reviews concerning SMC application for underwater robotic systems, an optimal SMC has been designed in [3] which the critical coefficients of sliding surface have been estimated using wavelet theory in order to acquire most suitable coefficients and gains for producing the optimal input torques. In [4] a perfect robust method as a Time Delay Control (TDC) algorithm is applied for controlling the UVMS autonomously. In this work, TDC in conjunction with the Terminal Sliding Mode (TSM) was considered to promote the robustness feature and tracking accuracy. However, some of the most important parameters in the TDC control law were not adjusted adaptively and this automatic gain tuning was regarded just for SMC by the fuzzy rules. Another contribution regarding SMC improvement has been done in [5] which is dedicated to the chattering reduction issue. In this case, a new reaching mode including an exponential function was designed in order to mitigate chattering frequencies. Concerning some researches addressed to the MPC approaches, an obstacle avoidance application using MPC associated with Fuzzy logic and the model predictive control of a floating manipulator is contributed in [13] and [14] respectively. An effective method for nonlinear MPC was considered for a 6 D.O.F manipulator in [6]. In this work, the model has first been linearized and decoupled by feedback and then an MPC algorithm has been implemented. A robust multi-loop control scheme including an Integral Sliding Mode (ISM) loop and MPC loop has been presented in [7] which the ISM role is rejection of uncertain terms due to unknown dynamics. Due to the problem of planning a trajectory for robots starting in an initial state and reaching the final state, research concerning the application of MPC for reference-tracking problems has been done in [8]. In [9] a novel combination of MPC and SMC with motivation of constraint satisfaction and robustness property has been presented. In this research, the proposed control algorithm is designed based on the MPC concepts. The staple achievement of this work is increasing the robustness attribute of MPC using fuzzy rules for omission of perturbation effects upon the UVMS.

Indeed, a novel perturbation compensating algorithm is proposed to fulfill the more accurate path tracking in the presence of environmental disturbances which finally lead to a robust MPC. The capability of the novel Robust Model Predictive Fuzzy (RMPF) algorithm is first analyzed. Then, the proposed RMPC algorithm is adopted to solve the UVMS tracking problem, and its performance is compared with a conventional MPC controller.

Nevertheless, the proposed control is a combination of MPC and uncertainty estimation and fuzzy compensator as the constraint satisfaction, optimal force/torque and robustness property are provided. Also, due to the high nonlinearities, uncertainties exerted to the UVMS and applied severe external disturbance, the compensating strategy or other robust control approach must be adopted to overcome the problems raised by this issue. However, for many nonlinear applications in the robotics area, the model

predictive control approach has been used as an optimal and model-based control strategy but should be enhanced in terms of the robustness factor to be more usable regarding mobile robots particularly when one uses them in more uncertain and disturbance conditions. Indeed, the motivation is to inherit the ability to explicitly deal with state and input constraints from MPC and the good perturbation effects reduction from fuzzy compensator. In the rest of this paper, the UVMS dynamical model with 4 degrees of freedom (DOF) is described and all the added forces and parameters for circle moving of the mobile spherical platform and coupled planar manipulator are shown in the next section. The third section is dedicated to explaining model predictive control approach. Then proposed robust MPC control law based on the fuzzy compensator and uncertainties estimator are presented in section IV. In section V, the computer simulation results and their comparison are shown to confirm high performance of the proposed control. Finally, the conclusion of this work is provided in section VI.

UNDERWATER MANIPULATOR DYNAMICS

In a UVMS, an underwater manipulator is mounted on the vehicle. Fig. 1 illustrates a 2 DOF underwater manipulator mounted on the spherical vehicle. The coupled effect between the manipulator and the vehicle is considered. The spherical vehicle is similar to the Omni-directional Intelligent Navigator (ODIN) underwater robot [18].

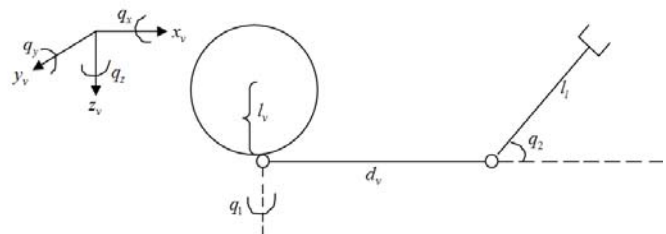

Fig.1. Underwater Vehicle-Manipulator System

The motion of ODIN consists of 3 linear motions and 3 revolute motions. Three linear motions are along the x , y and z axes that are named surge, sway and heave respectively. Also, three revolute motions are on x , y and z axes that are named roll, pitch and yaw, respectively. The Denavit-Hartenburg (D-H) parameters for UVMS with considering only revolute motions are shown in Table. 1.

Tab.1. D-H Parameters of UVMS

| Joint | a | α | d | θ |
|-------|-------|----------|-------|----------|
| 1 | 0 | -90 | 0 | q_x |
| 2 | 0 | +90 | 0 | q_y |
| 3 | 0 | 0 | l_v | q_z |
| 4 | d_v | +90 | 0 | q_1 |
| 5 | l_1 | -90 | 0 | q_2 |

where
 a, α, d, θ are link length, link twist, link offset and joint angle, respectively.

Fig. 2 illustrates an underwater vehicle-manipulator system 5 DOF with only revolute motions.

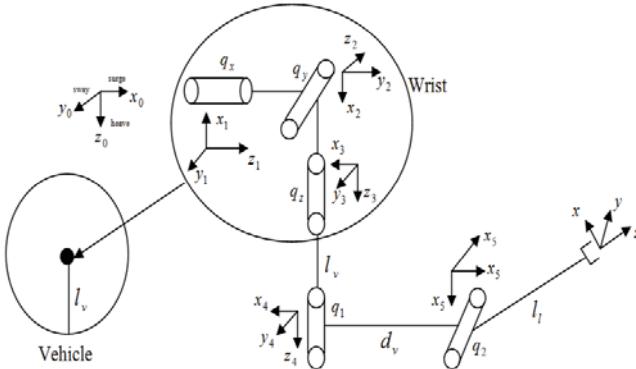

Fig. 2. UVMS with only revolute motions

KINETIC ENERGY

Added mass of an underwater vehicle-manipulator system is included in the system dynamics in the form of kinetic energy. Neglecting the kinetic energy of the manipulator due to added mass, the total kinetic energy of the UVMS can be written as

$$T = T_{RB} + T_A \quad (1)$$

Kinetic energy of the UVMS due to a rigid body is expressed as

$$T_{RB} = \frac{1}{2} m_d \dot{x}_{c_1}^2 + \frac{1}{2} m_l \dot{x}_{c_2}^2 + \frac{1}{2} I_1 \dot{q}_1^2 + \frac{1}{2} I_2 \dot{q}_2^2 + \frac{1}{2} I_z \dot{q}_z^2 + \frac{1}{2} I_y \dot{q}_y^2 + \frac{1}{2} I_x \dot{q}_x^2 + \frac{1}{2} m_v (\dot{x}_v^2 + \dot{y}_v^2 + \dot{z}_v^2) \quad (2)$$

In the above equation, x_{c_1} and x_{c_2} are mass centers of the first link (d_v) and the second link (l_l) of manipulator, respectively. Also \dot{x}_v, \dot{y}_v and \dot{z}_v are the linear velocities of the spherical vehicle along the x, y and z axes, respectively. I_1, I_2 are the moment of inertia of the manipulator. Also, I_x, I_y and I_z are the moments of inertia of spherical vehicle that is expressed as (3) [18].

$$I_x = I_y = I_z = \frac{8}{15} \pi \rho l_v^5 \quad (3)$$

where ρ is the water density and l_v is the radius of spherical vehicle. Kinetic energy of the spherical vehicle due to added mass is

$$T_A = \frac{1}{2} v_v^T M_{Av} v_v, v_v = [\dot{x}_v, \dot{y}_v, \dot{z}_v, \dot{q}_z, \dot{q}_y, \dot{q}_x]^T \quad (4)$$

when M_{Av} the inertia matrix of the spherical vehicle is expressed as the following [18].

$$M_{Av} = \text{diag}(\frac{2}{3} \pi \rho l_v^3, \frac{2}{3} \pi \rho l_v^3, \frac{2}{3} \pi \rho l_v^3, 0, 0, 0) \quad (5)$$

LAGRANGE FORMULATION

The UVMS is considered as an 8 DOF dynamic system. The Lagrange equation of motion in the matrix form is

$$\frac{d}{dt} \left(\frac{\partial T}{\partial \dot{q}} \right) - \left(\frac{\partial T}{\partial q} \right) = Q \quad (6)$$

$$= [F_1, F_2, F_3, \tau_4, \tau_5, \tau_6, \tau_7, \tau_8]^T$$

where T is the total kinematic energy of the system and it is obtained from equation (1). Also, q is the vector of generalized positions and \dot{q} is the vector of generalized velocities. The vector of generalized positions is

$$q = [x_v, y_v, z_v, q_z, q_y, q_x, q_1, q_2]^T \quad (7)$$

$Q_{n \times 1}$ in the equation (6) is the vector of generalized forces and torques applied to the UVMS. Substituting the above expression in equation (6), one obtains the dynamic equations of motion which include rigid body and added mass as follows

$$Q = M(q) \ddot{q} + C(q, \dot{q}) \dot{q} \quad (8)$$

where,

$M_{n \times n}(q)$ is total inertia matrix including rigid body inertia matrix and added inertia matrix.

$C_{n \times n}(q, \dot{q})$ is total Coriolis and centripetal matrix including rigid body and hydrodynamic Coriolis and centripetal matrix.

DRAG FORCE

Drag force in UVMS is divided in two parts. The first part includes drag force applied on link_1 and link_2 of the manipulator that are derived from following equations

$$D_1 = \frac{\rho}{2} c_d dia_1 \int_0^{d_v} v_1^2 dx_1, \quad (9)$$

$$D_2 = \frac{\rho}{2} c_d dia_2 \int_0^{l_l} v_2^2 dx_2$$

where dia_1, dia_2 and c_d are the diameter of link_1, the diameter of link_2 and the drag coefficient, respectively. Also, v_1, v_2 are translational velocities of links. The second part is the drag force applied on the spherical vehicle that is [18]

$$D_v = \text{diag}(d_t |\dot{x}_v|, d_t |\dot{y}_v|, d_t |\dot{z}_v|, d_1 |\dot{q}_z| + d_2, d_1 |\dot{q}_y| + d_2, d_1 |\dot{q}_x| + d_2) [\dot{x}_v, \dot{y}_v, \dot{z}_v, \dot{q}_z, \dot{q}_y, \dot{q}_x]^T \quad (10)$$

where d_r , d_l and d_a are translational quadratic damping factor, angular quadratic damping factor and angular linear damping factor respectively. Therefore, the total drag force applied on the UVMS is expressed as

$$D(q, \dot{q}) = [D_v \quad D_l \quad D_a]^T \quad (11)$$

GRAVITATIONAL AND BUOYANT FORCES

Buoyancy force is equal to the weight of the fluid displaced by link/body and acts through the center of buoyancy of the link/vehicle. Also, buoyant force is in the opposite direction of gravitational force.

$$F_U(q) = G(q) - B(q) = mg - \rho g v \quad (12)$$

where v is the volume of the link/vehicle. Therefore, this force has affected the heave motion of vehicle and link_2. By calculating the force ($F_U(q)$) in all motion directions, the potential energy (U) is calculated. Therefore, the matrix $h(q)$ is expressed as

$$h(q) = -\frac{d}{dt} \left(\frac{\partial u}{\partial \dot{q}} \right) - \left(\frac{\partial u}{\partial q} \right) = \left(\frac{\partial u}{\partial q} \right) \quad (13)$$

$$h(q) = [h_1, h_2, h_3, h_4, h_5, h_6, h_7, h_8]^T \quad (14)$$

In the recent vector, all the components are zero except h_3, h_4 .

$$h_3 = gm_v - g\rho v_v \quad (15)$$

$$h_8 = -0.5l_l m_l g \cos(q_2 + q_y) + 0.5g \cos(q_2 + q_y) \rho v_l l_l \quad (16)$$

where v_v, v_l are volume of the spherical vehicle and the cylindrical link, respectively.

FINAL DYNAMIC EQUATION OF UVMS

Using equations (8), (12), (14) one can write the final form of the dynamic motion equations of the UVMS as

$$Q = M(q)\ddot{q} + C(q, \dot{q})\dot{q} + D(q, \dot{q}) + h(q) \quad (17)$$

MODEL PREDICTIVE CONTROL

The objective of the nonlinear MPC is to accomplish a control law $\tau(t)$ in order to track the desired output path q_d at the next time ($t + t_h$) via the minimization of Cost Function (CF).

$$CF = f(e_q(t + t_h), X, \tau) \quad (18)$$

Where $e_q(t + t_h)$ is a predicted error, $q(t + t_h)$ is a t_h -step ahead prediction of the output and $t_h > 0$ is a prediction horizon. The Taylor series expansion is derived by Lie derivatives [11] for extracting a prediction model for robotic underwater manipulator as follows:

$$q(t + t_h) = q(t) + t_h \dot{q}(t) + \frac{t_h^2}{2!} \ddot{q}(t) \quad (19)$$

The state-space model of underwater robotic manipulator is expressed as follows:

$$Q(t) = \begin{bmatrix} q(t) \\ \dot{q}(t) \\ \ddot{q}(t) \end{bmatrix} = \begin{bmatrix} X_1 \\ X_2 \\ -M^{-1}(X_1)(C(X_1, X_2)X_2 + h(X_1) + D(X_1, X_2)) \\ 0 \\ 0 \\ M^{-1}(X_1)\tau(t) \end{bmatrix} + \quad (20)$$

Then, the prediction model (19) is rewritten as

$$q(t + t_h) = T(t_h)Q(t) \quad (21)$$

where,

$$T(t_h) = \begin{bmatrix} I_{nn} & t_h * I_{nn} & \left(\frac{t_h^2}{2!}\right) * I_{nn} \end{bmatrix}$$

Based on the same approach, the predicted desired trajectory q_d is shown as

$$q_d(t + t_h) = T(t_h)Q_d(t) \quad (22)$$

where,

$$Q_d(t) = [q_d \quad \dot{q}_d \quad \ddot{q}_d]^T$$

Now, the predicted error can be calculated by

$$e_q(t + t_h) = q(t + t_h) - q_d(t + t_h) = T(t_h)(Q(t) - Q_d(t)) \quad (23)$$

The cost function based on the tracking error is presented upon the future horizon:

$$CF = \frac{1}{2} \int_0^{t_d} (q(t + t_h) - q_d(t + t_h))^T (q(t + t_h) - q_d(t + t_h)) dt_h \quad (24)$$

The control effort can be achieved by tuning t_d . By the prediction model of error (23), the CF can be rewritten as

$$\begin{aligned} CF &= \frac{1}{2} \int_0^{t_d} e_q(t + t_h)^T e_q(t + t_h) dt_h \\ &= \frac{1}{2} \int_0^{t_d} (T(t_h)(Q(t) - Q_d(t)))^T (T(t_h)(Q(t) - Q_d(t))) dt_h \\ &= \frac{1}{2} (Q(t) - Q_d(t))^T R (Q(t) - Q_d(t)) \end{aligned} \quad (25)$$

where,

$$\begin{aligned} R &= \int_0^{t_d} T(t_h)^T T(t_h) dt_h \\ &= \begin{bmatrix} t_d * I_{nn} & \left(\frac{t_d^2}{2}\right) * I_{nn} & \left(\frac{t_d^3}{6}\right) * I_{nn} \\ \left(\frac{t_d^2}{2}\right) * I_{nn} & \left(\frac{t_d^3}{3}\right) * I_{nn} & \left(\frac{t_d^4}{8}\right) * I_{nn} \\ \left(\frac{t_d^3}{6}\right) * I_{nn} & \left(\frac{t_d^4}{8}\right) * I_{nn} & \left(\frac{t_d^5}{20}\right) * I_{nn} \end{bmatrix} = \begin{bmatrix} R_1 & R_2 \\ R_2^T & R_3 \end{bmatrix} \end{aligned}$$

The required condition, in order to minimize CF, is

$$\frac{\partial (CF)}{\partial \tau} = 0 \quad (26)$$

The above mentioned condition can be rewritten by the (20) and (25) as

$$\begin{aligned} &\left(\frac{\partial (M^{-1}(X_1)\tau(t))}{\partial \tau(t)}\right)^T [R_2^T \quad R_3] (N(t) - Q_d(t)) \\ &+ \left(\frac{\partial (M^{-1}(X_1)\tau(t))}{\partial \tau(t)}\right)^T R_3 M^{-1}(X_1) \tau(t) = 0 \end{aligned} \quad (27)$$

Hence, the optimal control is

$$\tau(t) = -\hat{M}(X_1) \{ [R_3^{-1} R_2 \quad I_{nn}] (N(t) - Q_d(t)) \} \quad (28)$$

where,

$$\begin{aligned} N(t) &= \begin{bmatrix} q(t) \\ \dot{q}(t) \\ -M^{-1}(X_1)(C(X_1, X_2)X_2 + h(X_1) + D(X_1, X_2)) \end{bmatrix} \\ [R_3^{-1} R_2 \quad I_{nn}] &= \begin{bmatrix} \frac{10}{(3t_d^2)} * I_{nn} & \frac{5}{(2t_d)} * I_{nn} & I_{nn} \end{bmatrix} \end{aligned}$$

Finally, the control law (28) of MPC is rewritten as

$$\tau_{MPC}(t) = -M(X_1) \left\{ \begin{array}{l} K_1(q - q_d) + \\ K_2(\dot{q} - \dot{q}_d) \\ -M^{-1}(X_1)(C(X_1, X_2)X_2 + h(X_1) + D(X_1, X_2)) - \ddot{q}_d \end{array} \right\} - \delta_{est}(t) \quad (29)$$

where,

$$k_1 = \frac{10}{(3t_d^2)} * I_{nn} \quad (30)$$

$$k_2 = \frac{5}{(2t_d)} * I_{nn} \quad (31)$$

$\delta_{est}(t)$ is the estimation of uncertainties which the approach calculation can be found in the next section.

ROBUST MPC

PERTURBATION ESTIMATOR

The stability analysis of the proposed control approach is carried out by the Lyapunov's second method [12] by which the stability of this highly uncertain robotic system is guaranteed. Due to the underwater circumstances, the matrices of M , C and h are affected by added mass, added Coriolis and buoyancy effects respectively. The changing of these matrices can be expressed by ΔM , ΔC , Δh as uncertainties. In addition to these uncertainties, drag force D , and external disturbance U_d are also considered and the entire perturbation effect δ is written as

$$\delta = -\{\Delta M \ddot{q} + \Delta C \dot{q} + \Delta h(q) + D(q, \dot{q}) + U_d\} \quad (32)$$

Based on the Lie derivatives and UVMS dynamical model, without considering the perturbation, one can write

$$\begin{aligned} \dot{q} &= L_f h_1(x) = X_2 \\ \ddot{q} &= L_f^2 h_1(x) + L_{g_2} L_f h_1(x) \tau \\ &= -\hat{M}^{-1}(q) \left(\hat{C}(q, \dot{q}) \dot{q} + \hat{h}(q) + \hat{D}(q, \dot{q}) \right) + \hat{M}^{-1}(q) \tau \end{aligned} \quad (33)$$

Substituting the MPC control law (29) in the dynamical model (33) and with considering the δ in (32), dynamical equation of the tracking error can be extracted as

$$\ddot{e}_q(t) + k_2 \dot{e}_q + k_1 e_q = M^{-1} e_\delta(t) \quad (34)$$

where, $e_\delta(t) = \delta - \delta_{est}$.

The state-space of the above dynamical equation concerning tracking error is expressed as

$$\dot{\tilde{e}} = \alpha \tilde{e} + \beta M^{-1} e_{\delta} \quad (35)$$

$$\text{with } \tilde{e} = \begin{bmatrix} e_q \\ \dot{e}_q \end{bmatrix}, \alpha = \begin{bmatrix} 0_{nn} & I_{nn} \\ -k_1 & -k_2 \end{bmatrix}, \beta = \begin{bmatrix} 0_{nn} \\ I_{nn} \end{bmatrix}$$

One can express the following Lyapunov equation if one declares the matrix α as Hurwitz. With determining the positive definite matrix ψ the equation is written as

$$\alpha^T \psi + \psi \alpha = -\varphi \quad (36)$$

The Lyapunov function is defined as

$$V = \tilde{e}^T \psi \tilde{e} + e_{\delta}^T \xi e_{\delta} \quad (37)$$

where, the matrix ξ is considered as a positive definite symmetric.

The time derivative of equation (37) is expressed in regards with (35) and (36) as

$$\dot{V} = -\tilde{e}^T \varphi \tilde{e} + 2e_{\delta}^T \{(M^{-1})^T \beta^T \psi \tilde{e} + \xi \dot{e}_{\delta}\} \quad (38)$$

If one determines \dot{e}_{δ} as

$$\dot{e}_{\delta} = -\xi^{-1} (M^{-1})^T \beta^T \psi \tilde{e} \quad (39)$$

Regarding uncertainty variations, because these are not considered, one can assume $\dot{\delta}(t) = 0$. The estimation of uncertainties can be written as dynamical equation based on (39) as

$$\dot{\delta}_{est} = \xi^{-1} (M^{-1})^T \beta^T \psi \tilde{e} \quad (40)$$

The globally stability is guaranteed by satisfying the $\dot{V} \leq 0$ which this satisfaction can be proven by substituting (38) in (39) and finally the derivative of Lyapunov is expressed as

$$\dot{V} = -\tilde{e}^T \varphi \tilde{e} \leq 0 \quad (41)$$

Since matrix φ is assumed as a positive definite symmetric matrix, the condition $\tilde{e}^T \varphi \tilde{e} > 0$ is true for all vectors $\tilde{e} \neq 0$. Therefore, $\dot{V} \leq 0$ and this assure that \tilde{e} and e_{δ} and are bounded based on the propriety of boundedness. By LaSalle's invariance theorem, the origin is also asymptotically stable. The global asymptotic stability of the estimated closed loop system with uncertainties is guaranteed.

FUZZY COMPENSATOR

If one considers $\tilde{e} = g_1(e, \dot{e})$ and $\rho = g_2(e, \dot{e})$ it can be written as $\rho + \tilde{e} = g_3(e, \dot{e})$ and the equation (40) can be changed to

$$\delta_{est} = \int \xi^{-1} (M^{-1})^T \beta^T \psi g_3(e, \dot{e}) - \int \rho \xi^{-1} (M^{-1})^T \beta^T \psi + \varepsilon_1 \quad (42)$$

$$\delta_{est} = \hat{L}_1(e, \dot{e}) + \hat{L}_2(e, \dot{e}) + \varepsilon_1, \hat{k} = \hat{L}_1 + \hat{L}_2$$

$$\rho \delta_{est} = \rho \hat{k}(e, \dot{e}) + \rho \varepsilon_1 \quad (43)$$

The output of fuzzy compensator is defined as follows

$$u_{fuzzy} = \rho(x) \delta_{est} + \varepsilon \quad (44)$$

where $\rho(x)$, is output of fuzzy compensator after defuzzification computed by the Center of Gravity (COG) approach as follow

$$z = \frac{\sum_{i=1}^n c_i \mu_{A_i}(x) \mu_{B_i}(y)}{\sum_{i=1}^n \mu_{A_i}(x) \mu_{B_i}(y)} \quad (45)$$

Regarding compensator architecture, a two-input single-output Mamdani's inference fuzzy engine is adopted. $\rho(x)$ is determined by inference on input linguistic variables $e(t)$ and $\dot{e}(t)$. Also, fuzzy inference engine is implemented using 49 rules of Table 2 in which the following symbols have been used:

NB: Negative Big; NM: Negative Medium; NS: Negative Small; ZE: Zero; PS: Positive Small; PM: Positive Medium; PB: Positive Big.

Fuzzy implication is modeled by Mamdani's minimum operator, the conjunction operator is Min, the t-norm from compositional rule is Min and for the aggregation of the rules the Max operator is used.

For the fuzzy compensator, the error signal and its derivative are adopted as input signals which fuzzification stage is conducted by the membership function shown in Fig. 3.

Tab. 2. Fuzzy Inference Rules

| \dot{e}/e | NB | NM | NS | ZE | PS | PM | PB |
|-------------|----|----|----|----|----|----|----|
| NB | NB | NB | NB | NB | NM | NS | PS |
| NM | NB | NM | NM | NM | NS | ZE | PS |
| NS | NB | NM | NS | NS | ZE | PS | PM |
| ZE | NM | NM | NS | ZE | PS | PM | PM |
| PS | NS | NS | ZE | PS | PS | PM | PB |
| PM | NS | ZE | PS | PM | PM | PM | NB |
| PB | ZE | PS | PM | PB | PB | PB | ZE |

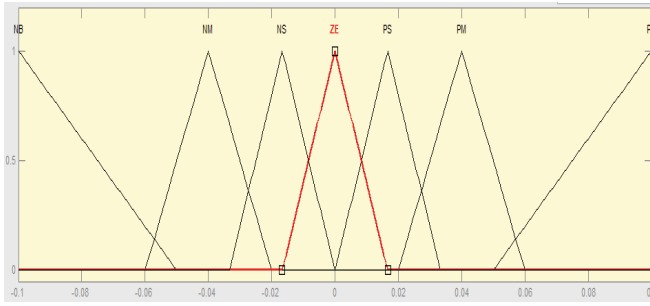

a) input membership function (e, \dot{e})

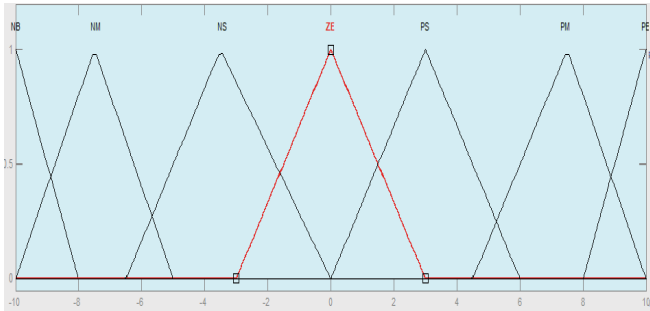

b) output membership function ρ

Fig. 3. Input-Output Membership Functions

Concerning promoted control law, the proposed Robust Model Predictive Fuzzy (RMPF) control law is considered as

$$U_{RMPF}(t) = U_{MPC}(t) - U_{fuzzy}(t) + U_d \quad (46)$$

The proposed control system of UVMS is shown in Fig. 4.

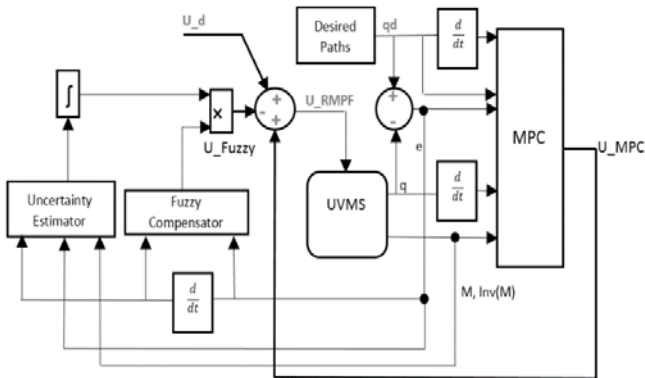

Fig. 4. Proposed Control RMPF

COMPUTER SIMULATIONS

In this section, in order to argue the mathematical model of the proposed controller, the simulations of proposed design RMPF and also MPC are done. The desired trajectories which must be tracked in the time interval of 20 seconds by 4 degree of freedom UVMS are chosen as.

A circle trajectory for mobile platform using X (surge motion) and Z (heave motion) axis and also with a pitch motion. Initial conditions are considered zero.

$$X = \sin\left(\frac{\pi}{5}t\right)$$

$$Z = \cos\left(\frac{\pi}{5}t\right)$$

$$q_{Pitch} = \pi(1 - e^{-\frac{t}{2}})$$

For a 1 degree of freedom movement for a coupled manipulator the initial condition is considered zero.

$$q_{Link} = \pi(1 - e^{-\frac{t}{2}})$$

Fig. 5 illustrates a four degree of freedom underwater vehicle-manipulator system with the following vector of positions:

$$q = [X, Z, q_{Pitch}, q_{Link}]^T$$

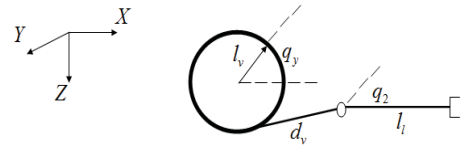

Fig. 5. UVMS with 4 Degree of Freedom

Also, external disturbances are shown in Fig. 6 and variable mass of manipulator is expressed as

$$m_{Link}(t) = m_0 + 10\cos(0.5t)$$

Table. 3 gives the parameters of underwater vehicle-manipulator system that was used in computer simulations.

Table. 3. Parameters of UVMS

| | |
|-----------------------------------|--------------------------------------------------------------------------------------|
| Added Mass Force Coefficient | $E_1 = 2 \text{ kg}, E_2 = 2 \text{ kg}$ $E_3 = 1 \text{ kg}, E_4 = 1 \text{ kg}$ |
| Drag Force Coefficient | $F_1 = 5 \text{ kg}, F_2 = 5 \text{ kg}$ $F_3 = 1 \text{ kg}, F_4 = 1 \text{ kg}$ |
| Mass of Spherical Vehicle m_v | 100 (kg) |
| Mass of Link m_l | 20 (kg) |
| Radius of Spherical Vehicle l_v | 1 (m) |
| Length of Link l_l | 1 (m) |

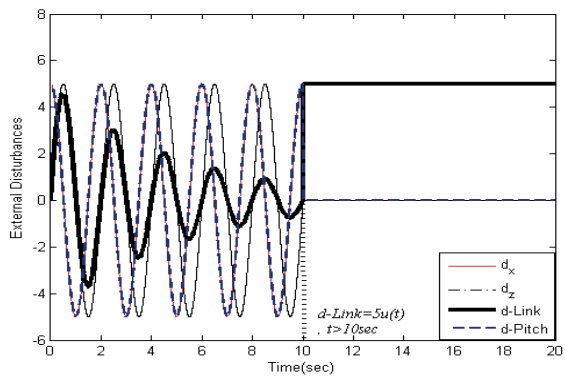
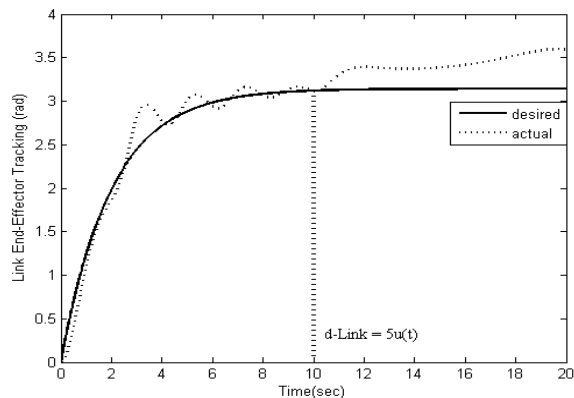
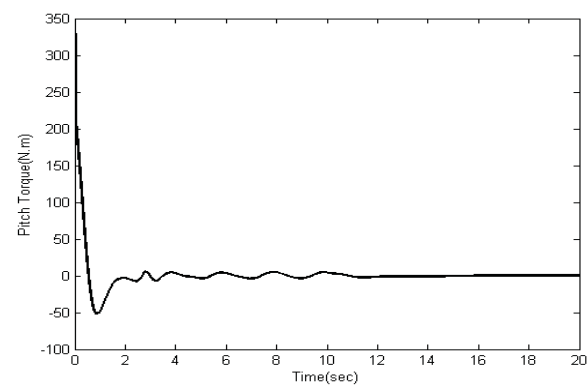
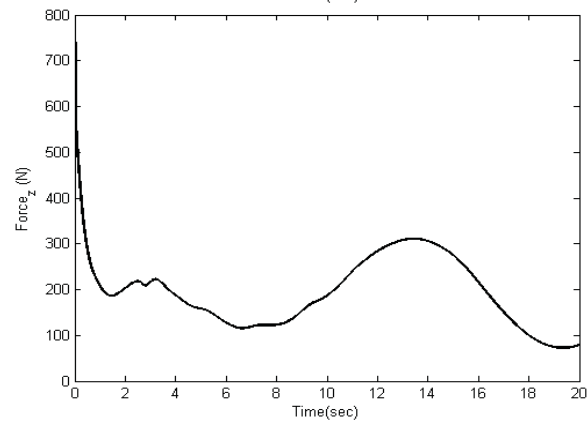
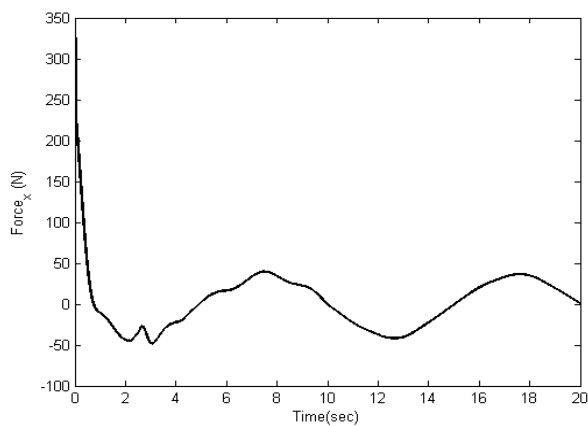
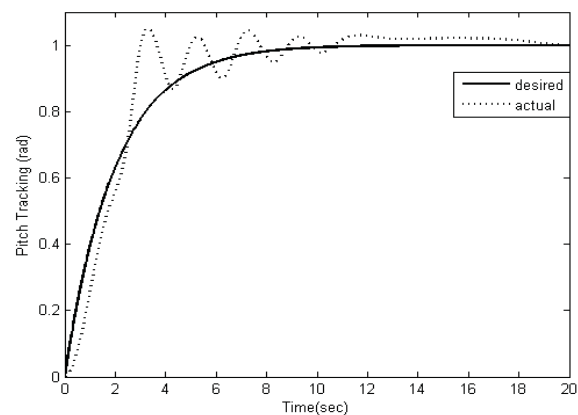
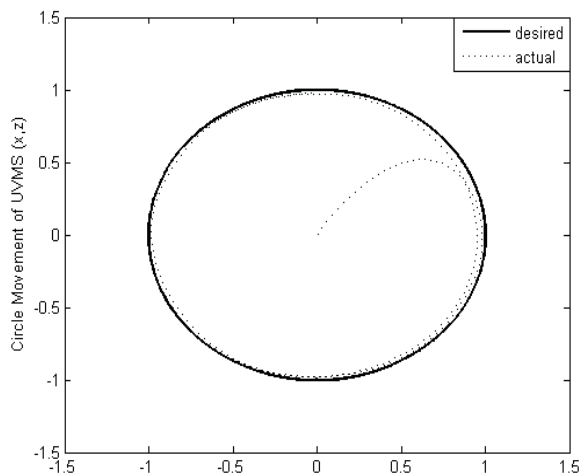

Fig. 6. External Disturbances



A1-Trajectory tracking

Also, concerning adjustable coefficient of MPC, the value of τ_r is given by 1. The simulation results of MPC are shown in Fig. 7 and with sustaining of the same perturbation conditions, the simulated results of the proposed controller are shown in Fig. 8.



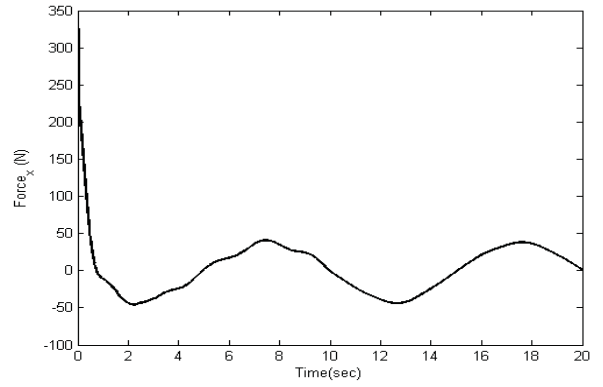
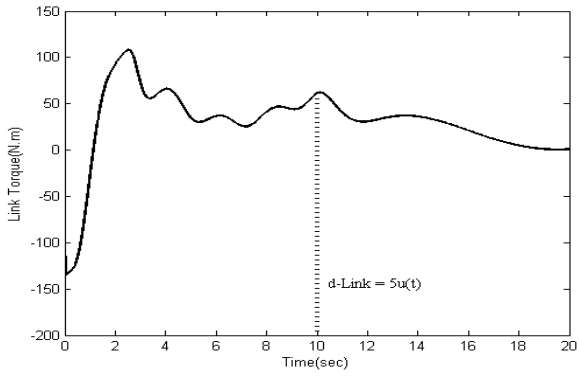

B1-Input control signals
Fig. 7. MPC approach

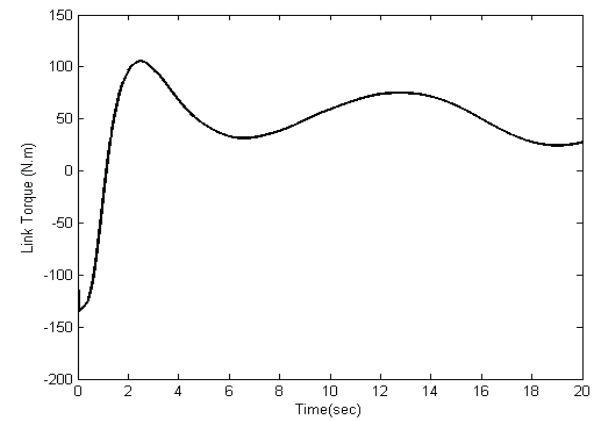
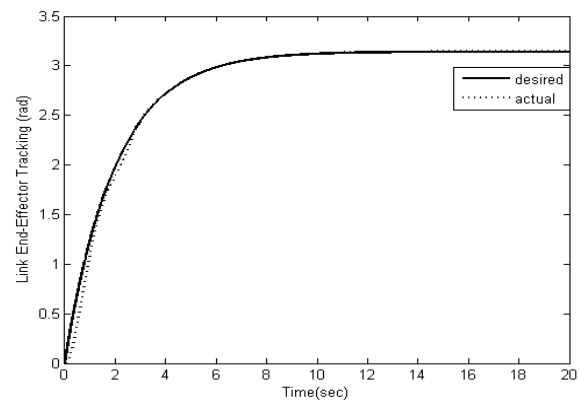
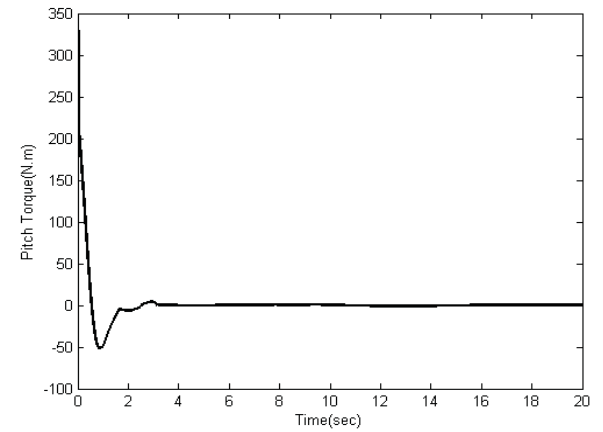
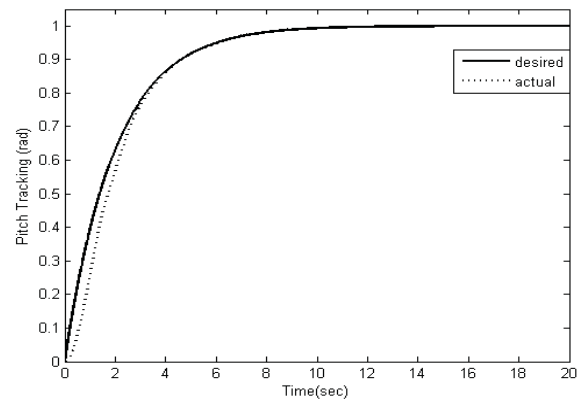
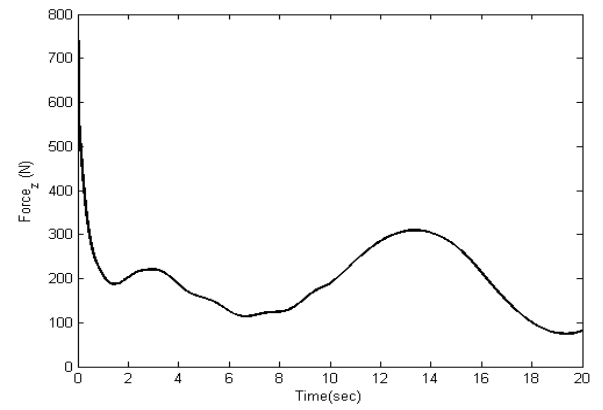
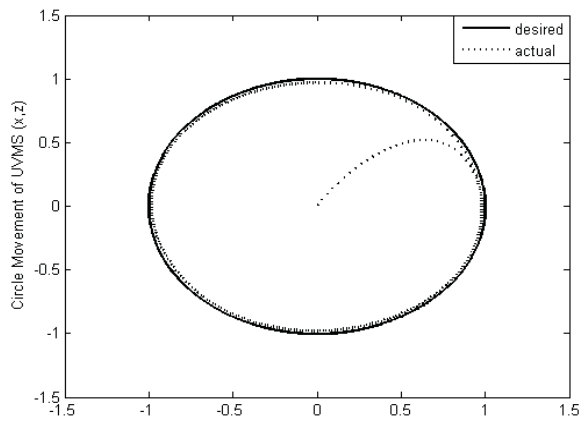

B2-Input control signals

A2-Trajectory tracking

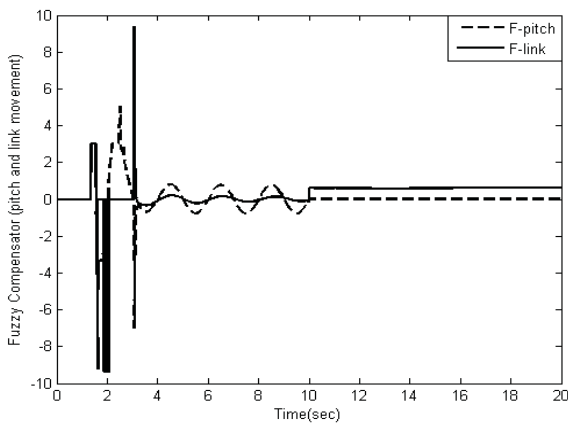
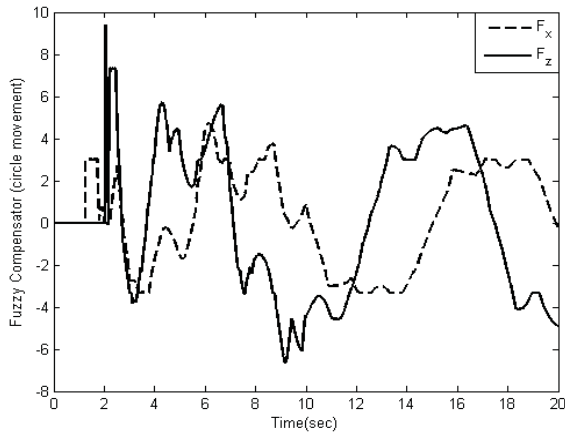

C-Output of fuzzy compensator
Fig. 8. Proposed control approach RMPF

The proficient performance of the proposed controller is obviously observed by a comparative appraisal. Indeed, when the applied external disturbance considered for coupled manipulator is switched over to the other kind of disturbance signal shown in Fig. 6, the MPC is not capable to follow the rest of the desired link path shown in Fig. 7-A1. For a similar condition, in terms of switching over of applied external disturbance of coupled link while the proposed controller RMPF is operated, the tracking duty is literally provided by this controller and there is no divergence shown in Fig. 8-A2 because of good operation of the fuzzy compensator. Also, concerning the pitch motion of UVMS, the control response for the proposed controller is much more applicable than MPC. The RMPF response is critically damped and all the under damping symptoms observed in MPC response are removed.

CONCLUSION

Water depths are one of the environments in which operation of the robotic systems such as Autonomous UVMS, Remotely Operated Vehicle (ROV), and fixed underwater manipulators is intensively influenced by the special forces

and finally high nonlinear terms and uncertainties are unfolded by the rewritten dynamical equations. Commonly, robustness property of designed controllers for the mentioned underwater systems is achieved by applying the robust strategies such as SMC. However, SMC in conjunction with the chattering effects on the input control signals is particularly visible in the presence of severe external disturbances. In this research, because of gathering the robustness property and MPC attributes simultaneously, MPC based approach with two main subsystems including perturbation estimator and fuzzy compensator is chosen as the proposed method. The computer simulations are done with high accuracy in tracking and are obviously observed in comparison with conventional MPC.

REFERENCES

1. Islam S., Liu J.: *Robust Sliding Mode Control for Robot Manipulators*. IEEE Transactions on Industrial Electronics, vol. 58(6), pp. 2444-2453, 2011.
2. F. Piltan and B. Sulaiman.: *Review of Sliding Mode Control of Robotic Manipulator*. World Sciences Journal, vol. 18(12), pp. 1855-1869, 2012.
3. Esfahani H. N., Azimirad V., Eslami A., Asadi S.: *An optimal sliding mode control based on immune-wavelet algorithm for underwater robotic manipulator*. Proceedings of the 21st Iranian Conference on Electrical Engineering (ICEE). Mashhad, Iran, 2013. DOI: 10.1109/IranianCEE.2013.6599587.
4. Esfahani H. N., Azimirad V., Danesh M.: *A time delay controller included terminal sliding mode and fuzzy gain tuning for underwater vehicle-manipulator systems*. Ocean Engineering, vol. 107, pp. 97-107, 2015.
5. Esfahani H. N., Azimirad V., Zakeri M.: *Sliding Mode-PID Fuzzy controller with a new reaching mode for underwater robotic manipulators*. Latin American Applied Research, vol. 44(3), pp. 253-258, 2014.
6. Vivas A., Mosquera V.: *Predictive functional control of a PUMA robot*. Proceedings of the Conference on Automatic Control and System Engineering (ACSE 05), CICC. Cairo, Egypt, 2005.
7. Incremona G. P., Ferrara A., Magni L.: *Hierarchical Model Predictive/Sliding Mode Control of Nonlinear Constrained Uncertain Systems*. Proceedings of the 5th IFAC Conference on Nonlinear Model Predictive Control (NMPC). Seville, Spain, 2015. DOI: 10.1016/j.ifacol.2015.11.268.
8. Ghazaei Ardakani M., Olofsson B., Robertsson A., Johansson R.: *Real-Time Trajectory Generation using Model Predictive Control*. Proceedings of the IEEE International Conference on Automation Science and

Engineering (CASE). Gothenburg, Sweden. pp. 942 – 948, 2015. DOI: 10.1109/CoASE.2015.7294220.

9. Wang Y., Chen W., Tomizuka M., Alsuwaidan B. N.: *Model predictive sliding mode control: for constraint satisfaction and robustness*. ASME 2013 Dynamic Systems and Control Conference, Palo Alto, California, USA. vol. 3, ISBN 978-0-7918-5614-7, 2013.
10. Fossen. T. I.: *Marine Control Systems: Guidance, Navigation and Control of Ships, Rigs and Underwater Vehicle*. Marine Cybernetics AS, Norway. pp. 570-579, ISBN 82-92356-00-2, 2002.
11. Krid. M, Benamar. F, and Lenain. R.: *A new explicit dynamic path tracking controller using Generalized Predictive Control*. International Journal of Control, Automation and Systems, Springer, vol. 15, Issue 1, pp. 303-314, 2017.
12. Spong M.W., Hutchinson S., Vidyasagar M.: *Robot Dynamics and Control*. 2nd ed. John Wiley & Sons, Inc.; Hoboken, NJ, USA: 2004.
13. Jasour A. M., Farrokhi M.: *Path Tracking and Obstacle Avoidance for Redundant Robotic Arms Using Fuzzy NMPC*. Proceedings of the American Control Conference, pp. 1353-1358. St. Louis, MO, USA, 2009. DOI: 10.1109/ACC.2009.5160408.
14. Rubus. T, Seweryn. K, and Sasiadek. J. Z.: *Application of predictive control for manipulator mounted on a satellite*. Archives of Control Sciences, vol. 28(LXIV), pp. 105–118, 2018.
15. Lisowski. J.: *Analysis of Methods of Determining the Safe Ship Trajectory*. TRANSNV-INTERNATIONAL JOURNAL ON MARINE NAVIGATION AND SAFETY OF SEA TRANSPORTATION, Vol. 10(2), pp. 223-228, JUN 2016.
16. Lisowski. J.: *Optimization-supported decision-making in the marine mechatronics systems*. mechanics and material II. Book series: solid state phenomena, Vol. 210, pp. 215-222, 2014.
17. Tomera. M.: *Ant colony optimization algorithm applied to ship steering control*. KNOWLEDGE-BASED AND INTELLIGENT INFORMATION & ENGINEERING SYSTEMS 18TH ANNUAL CONFERENCE, KES-2014 Book Series: Procedia Computer Science, Vol. 35, pp. 83-92, 2014.
18. Sun, Y. C., Cheah, C. C.: *Adaptive set point control for autonomous underwater vehicles*. In: Proceedings of IEEE Robotics Decision and Control Conference, Hawaii USA, 2, pp. 1262–1267, 2003.

CONTACT WITH THE AUTHOR

Hossein Nejatbakhsh Esfahani

e-mail: nejatbakhsh.application@yahoo.com

Gdansk University of Technology
ul. G. Narutowicza 11/12 , 80-233 Gdansk

POLAND