

Control methods for PWM rectifier cooperating with variable speed PM generator

WITOLD MAZGAJ, ZBIGNIEW SZULAR and TOMASZ WĘGIEL

The paper deals with cooperation between pulse width modulation (PWM) rectifier and variable speed synchronous generator which is applied especially in small water or wind plants. In such applications, the synchronous generator, which is usually permanent magnet (PM) generator, rotates at a variable speed which depends on water or wind energy. Therefore, this energy should be converted to the parameters of the three-phase power grid with the use of a power electronic unit. The main aim of the control strategy is to transfer a maximum possible amount of energy produced by the water turbine or the wind turbine connected to a synchronous generator. The second purpose of the control method is to decrease the amount of higher harmonics of generator currents. The paper describes two basic methods which are used in control systems of the PWM rectifiers. The first one is the sinusoidal PWM method, and the second method relates to the hysteresis switching of the PWM rectifier transistors. A significant part of the paper is devoted to control principles of the PWM rectifier which cooperates with a variable speed PM synchronous generator. Special attention is paid to higher harmonics of PM generator currents with respect to individual methods.

Key words: PM synchronous generator, PWM rectifier, sinusoidal PWM method, hysteresis control method, higher harmonics

1. Introduction

Energy in small water or wind plants is often produced by permanent magnet (PM) synchronous generators which quite often work at variable rotational speed. Therefore, this energy should be converted to the parameters of the three-phase power grid (3×400 V, 50 Hz) by means of a power electronic unit. In practice, two schemes of energy conversion are used. The first one is based on an uncontrolled rectifier and DC-DC converter which can increase DC voltage. In the second one the pulse width modulation (PWM) rectifier is applied. In both cases, the voltage source inverter is coupled with power grid using transformer or induction chokes. The first method of energy conversion is quite rarely applied, and it is not recommended because the diode rectifier can cause significant distortion of the generator currents with respect to sinusoidal shapes [2]. As a result

The Author are with Cracow University of Technology, Institute of Electromechanical Energy Conversion 31-155 Krakow, Warszawska 24. E-mails: pemazgaj@cyfronet.pl, aszs@poczta.fm, pewegiel@cyfronet.pl

Received 12.08.2013.

of this distortion the generator torque contains an alternating component with relatively high amplitude. It is a certain disadvantage since the presence of this alternating component of the torque can significantly influence durability and reliability of the turbine - generator unit. In this case, we do not have the possibilities to decrease directly the amount of higher harmonics of the PM generator current. An application of the PWM rectifier results in almost sinusoidal shapes of the generator currents, so it enables to reduce alternating component of the PM generator torque. The energy conversion system with the PWM rectifier is presented in Fig. 1. Energy produced by the PM generator is converted into direct current energy (DC link), and then it is transferred to the power grid via voltage source inverter [1, 3, 5].

The task of the control system is not only the switching of transistors in both converters but also allowing us to adjust the position of turbine blades. The correct operation of the control system requires measurements of suitable currents and voltages of the power electronic unit and the wind or water speed should be controlled. Therefore, the characteristics $P = f(\omega)$ describing the relation between the power of the PM generator and its rotational speed must be stored in the memory of the control system.

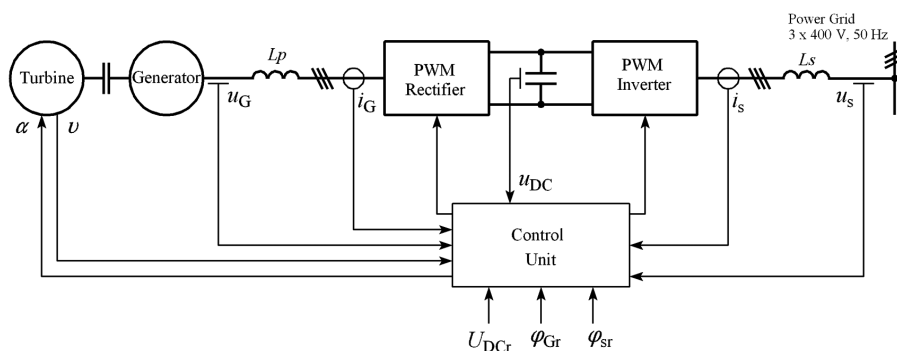

Figure 1. Energy conversion system with the PWM rectifier for a small water or wind plant: U_{DCr} – assumed voltage of the DC link, i_s – output current of the PWM voltage source inverter, u_s – voltage of the power grid, φ_{Gr} , φ_{sr} – assumed phase angle of the generator and output current respectively, u_G , i_G – voltage, and current of the PM generator, v – speed of wind or water, α – angle of the turbine blades.

The main aim of the control method in the energy conversion system is to transfer a maximum possible amount of energy produced by the turbine – PM generator unit to the power grid. The second purpose of the control strategy is to decrease the amount of higher harmonics in converter currents. The Total Harmonic Distortion factor depends on the assumed method of transistor switching in power electronic converters.

2. Sinusoidal PWM method in control of the rectifier

In energy conversion systems, the space vector control (SVC) method is sometimes used for the control of the PWM rectifier. In this case the three-phase PM synchronous generator is treated as an induction motor which rotates at a constant speed. The use of this control method is not recommended because electromechanical time-constants of the turbine - PM generator unit are much higher with respect to the electrical time-constants in power transmission systems. The sinusoidal PWM method and the hysteresis current control (HCC) method are simpler than the SVC methods.

In the sinusoidal PWM method the sinusoidal signal is compared with a saw-tooth signal. The amplitude of this sinusoidal signal is determined by the assumed root mean squared (rms) value of the PM generator current. The pulse sequence, obtained from this comparison, is applied to the switching of converter transistors. In this method, the switching frequency is constant and it is equal to the frequency of the saw-tooth signal. Unlike the PWM converters which are applied in power transmission systems, the phase of the assumed sinusoidal signal has to depend on the phase of the PM generator output voltage. Phasor diagrams of voltages in the generator - PWM rectifier system are shown in Fig. 2.

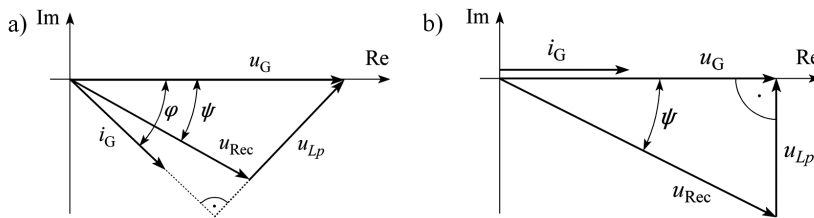

Figure 2. Phasor diagram in the PM generator – PWM rectifier system: U_G , I_G – output phase voltage and current of the PM generator respectively, U_{Rec} – input phase voltage of the PWM rectifier, U_{Lp} – voltage drop on the choke L_p .

Using the presented phasor diagram the phase angle between the output phase voltage and the phase current of the PM generator can be determined by the following relation [4]:

$$\varphi = \arctg \left(\frac{3U_G^2}{\omega L_p P} - \frac{\cos \psi}{\sin \psi} \right) \quad (1)$$

where P is the power which can be generated at the given speed of wind or water stream, L_p denotes inductance of the choke connecting the PM generator with the PWM rectifier, and ψ is the angle between the phasor of the output phase voltage and the phasor of the first harmonic of the PWM rectifier phase input voltage.

It comes from the formula (1) that the angle ψ depends on the phase angle and it also depends on the PM generator output voltage. Omitting voltage drops on both the internal resistance and the inductance of the PM generator it can be assumed that the output voltage depends directly proportional on the rotational speed of the turbine - generator

unit i.e. $U_G = k\omega$, where k has a constant value. Thus, on the basis of the formula (1) it can be written as follows:

$$\psi = \arctg \left(\frac{L_P P}{3k^2 \omega - \text{tg}\varphi L_P P} \right). \quad (2)$$

It seems that the recommended value of the angle φ should be equal to zero. However, in some cases it is necessary to take into account not only the internal resistance but particularly the inductance of the PM generator. As a result of this fact the φ angle will be different than zero. It is also worth underlining that the value of the power P , which is transferred to three-phase grid, can change due to variable hydrological conditions or changeable wind power.

In small water or wind plants the rotational speed of the turbine – PM generator unit is variable owing to different hydrological conditions or changeable wind force. Hence the generator output voltage and also the reactance X_P depend on this rotational speed. The application of the PWM rectifier allows us to keep the U_{DC} voltage in the DC link. On the basis of the phasor diagram presented in Fig. 2 it can be proved that the U_{DC} voltage can be written as follows:

$$U_{DC} = \frac{2\sqrt{2}\omega L_P P}{3U_G(\omega) m \sin\psi(\omega)} \quad (3)$$

where m denotes the coefficient of the modulation depth. Assuming that $U_G = k\omega$ the coefficient m is equal:

$$m = \frac{2\sqrt{2}L_P P}{3k \sin\psi(\omega) U_{DCr}} \quad (4)$$

where U_{DCr} is the assumed voltage in the DC link.

The coefficient m of the modulation depth depends on the angle ψ which is the function of the speed of the turbine – PM generator unit. It means that the setting of the coefficient m should be carried out simultaneously with the adjustment of the angle ψ . Figures 3 and 4 show the family of the characteristics $\psi = f(\omega)$, and the family of the characteristics $m = g(\omega)$ for two values of the L_P choke (Fig. 1) and for some values of the angle φ and for some values of the power P .

Numerical calculations were made for the following nominal parameters of the PM synchronous generator: $P_N = 30\text{kW}$, $U_N = 500\text{V}$, $I_N = 35\text{A}$, $f = 50\text{Hz}$. In the analyzed case, the choke inductance which connects the PM generator with the PWM rectifier was equal to 5 mH. For example, Fig. 5 presents waveforms of the generator output phase voltage u_G and current i_G , and input phase voltage u_{Rec} of the PWM rectifier for two assumed values of the phase angle between the output phase voltage and the phase current of the PM generator.

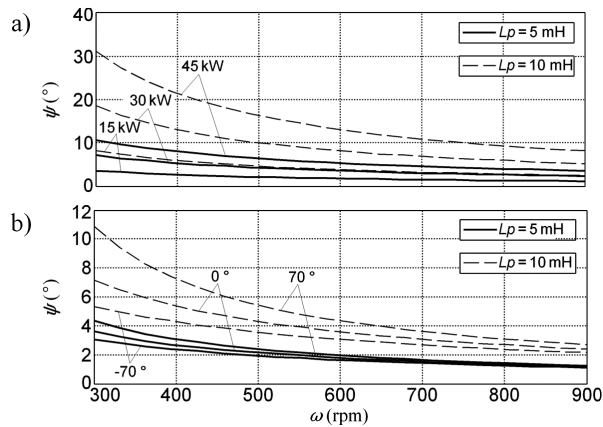

Figure 3. The angle ψ as the function of the rotational speed ω of the turbine – PM generator unit for assumed: a) power P ($\varphi = 0^\circ$), b) phase angle φ ($P = 30\text{kW}$).

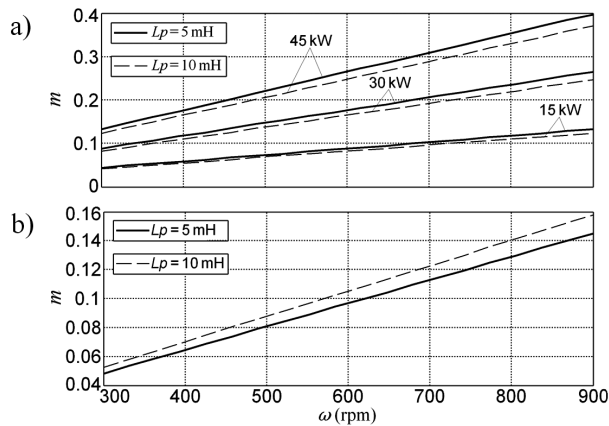

Figure 4. The coefficient m of the modulation depth as functions of the rotational speed ω of the turbine – PM generator unit for assumed: a) power P ($\varphi = 0^\circ$), b) phase angle φ ($P = 30\text{kW}$).

3. Hysteresis current control method in the PWM rectifier

In the HCC method the phase current flowing from the PM generator to the PWM rectifier can change between the exactly determined sinusoidal curves in respect to the assumed sinusoidal waveform $i_a(t)$ (Fig. 6). Similar waveforms to those presented in Fig. 5 for the HCC method are shown in Fig. 7. Each phase current is controlled separately by means of hysteresis controllers. However, the phase current does not change regularly as in the one-phase voltage source inverter since the current in the given phase depends on the transistor state in other phases.

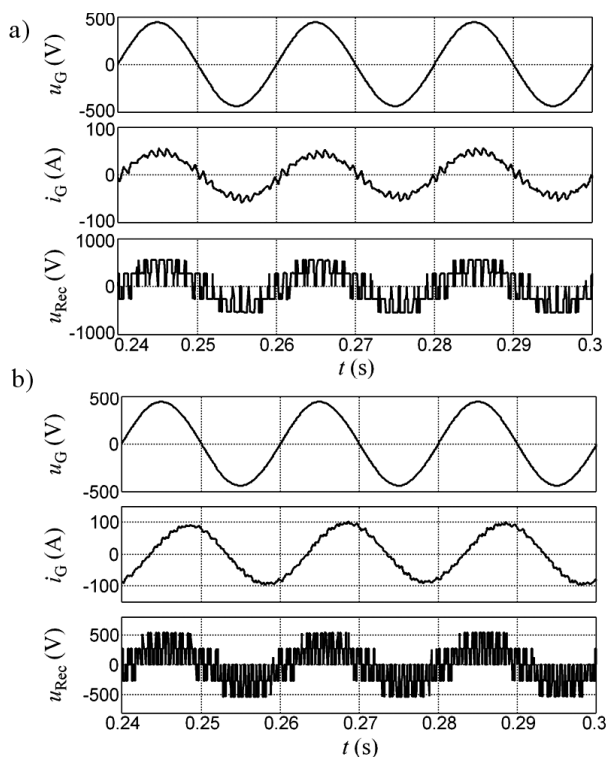

Figure 5. Generator output phase voltage u_G and current i_G , and input phase voltage u_{Rec} of the PWM rectifier: a) $\varphi = 0^\circ$, $\psi = 9.7^\circ$, b) $\varphi = 60^\circ$, $\psi = 12.5^\circ$.

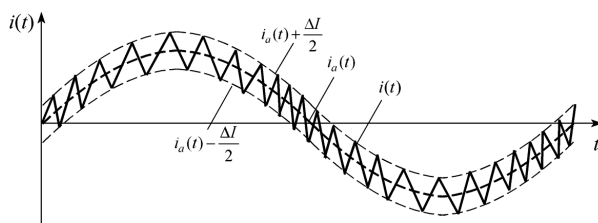

Figure 6. Phase current in the PWM rectifier controlled with the HCC method; $i_a(t)$, ΔI – the assumed sinusoidal current waveform and value of the current changes respectively.

In this case the PWM rectifier operates at a variable frequency which depends on both the assumed ΔI value and the choke inductance which connects the PM synchronous generator with the PWM rectifier. It is worth stressing that this method allows us to control directly the PWM rectifier currents. The assumed sinusoidal current signals should be synchronized with the output voltage of the PM generator. In general, phase shifts between voltages and currents of the PM generator should be equal to zero, al-

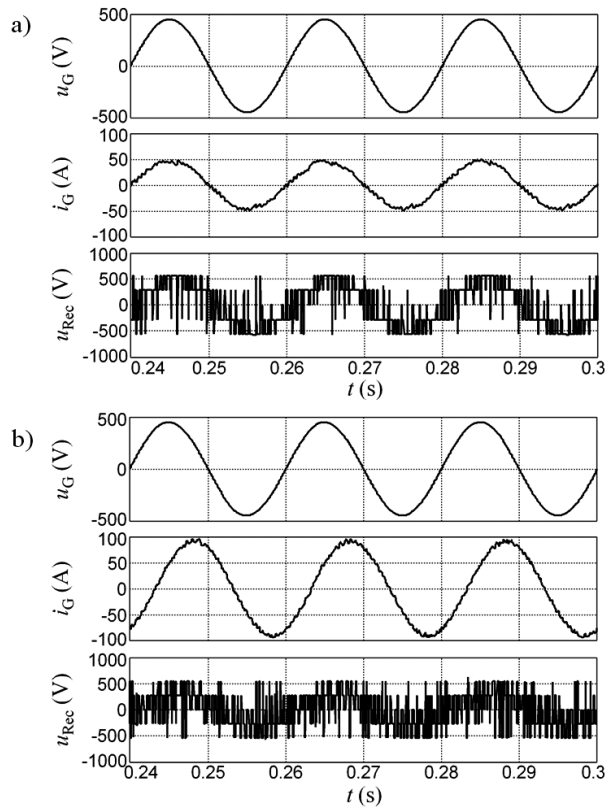

Figure 7. Generator output phase voltage u_G and current i_G , and input phase voltage u_{Rec} of the PWM rectifier controlled with the HCC method: a) $\varphi = 0^\circ$, $I_{Gmax} = 50\text{A}$, b) $\varphi = 60^\circ$, $I_{Gmax} = 94\text{A}$.

though, these shifts can be adjusted. As mentioned previously, in the HCC method the PM generator currents can change only between exactly determined sinusoidal waveforms. However, it does not guarantee that THD factor of the PM generator currents has relatively low value.

4. Comparison of higher harmonics of the PM generator currents

As it was mentioned above, the second task of the control methods is to reduce the amount of higher harmonics of the PM generator currents. At first, numerical calculations were performed for the HCC method, and permissible current changes ΔI were assumed. Studies have shown that in this case the harmonic spectrum of the converter currents includes almost all harmonic, which significant influence the value of the THD factor [6]. The main reason resides in quite wide range of transistor switching frequency during hysteresis current control. A much better spectrum of current harmonics occurs

when the rectifier works with the use of the PWM method, although in this case the PM generator currents can not be adjusted directly. On the basis of numerical calculation results the average frequency of the transistor switching was determined. For each ΔI value the THD factor was calculated for the first one hundred harmonics. Changes of the THD factor and the average switching frequency as the function of the $\Delta I/I_a$ value are shown in Fig. 8, where $\Delta I/I_a$ denotes a relative value of current changes with respect to the amplitude of the generator current.

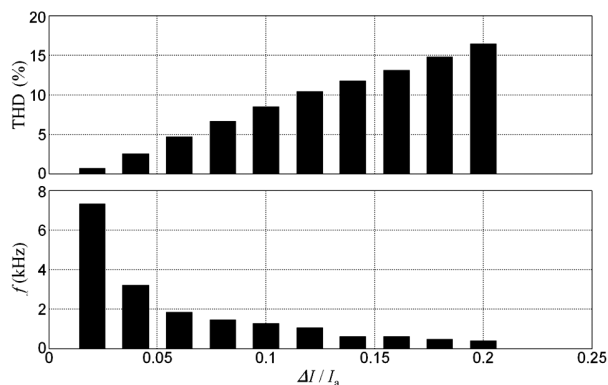

Figure 8. THD factor and average switching frequency as a function of the $\Delta I/I_a$ value in the HCC method.

It was assumed that the frequencies of the saw-tooth signal in the sinusoidal PWM method were equal to the average frequencies calculated previously (transistor switching with the HCC method). Fig. 9 shows the THD factor depending on the assumed saw-tooth signal frequency in the sinusoidal PWM method.

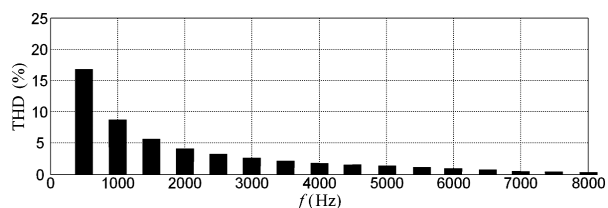

Figure 9. THD factor as a function of the assumed saw-tooth signal frequency in the sinusoidal PWM method.

An increase in the transistor switching frequency during the decrease in the ΔI value in the HCC method is rather obvious. However, quite surprising is the fact that the THD factor in the HCC method has relatively significant values in comparison with the amount of higher harmonics in the sinusoidal PWM method. The main reason resides in a fact that the current changes in the given phase depend on the working state of transistors in two other phases. As a result of this interaction, the transistor switching frequency changes in wide range (from a few hundreds of hertz to even a dozen or so kilohertz).

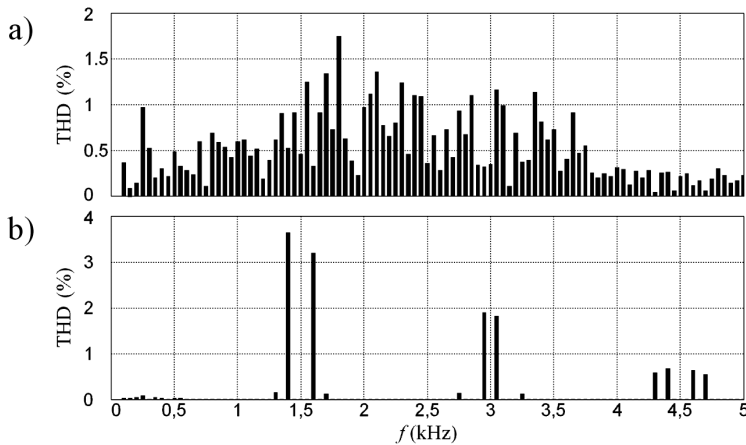

Figure 10. Spectrum of current higher harmonics of the PWM rectifier working with: a) the HCC method, b) the sinusoidal PWM method; the first harmonic is not shown, switching frequency was equal to 1500 Hz.

It means that almost all current harmonics have significant influence on the THD factor value. It is worth stressing that power receivers connected to the three-phase grid have quite often non-linear characteristics. In this case, when the sinusoidal PMW method is applied the amount of current higher harmonics increases significantly in comparison to the use of the HCC method. The appropriate harmonic spectrums are shown in Fig. 10.

5. Conclusions

The variable rotational speed of the turbine - generator unit has a direct impact on values of the coefficient m of the modulation depth and the angle ψ , unlike the case when the PWM rectifier is supplied from the grid with constant frequency 50 Hz. An increase of the rotational speed of the turbine – PM generator unit causes a decrease of the angle ψ value but the coefficient m increases.

It is worth underlining that first of all the power P has influence on values of the angle ψ and the coefficient m . Changes of this angle increase when the rotational speed of the turbine – generator unit decreases. However, changes of the coefficient m have an opposite character. The influence of the inductance L_p on the angle ψ and coefficient m is visible at low rotational speed values.

The HCC method does not guarantee a relatively low value of the higher harmonic amount of the PM generator current, despite the a priori assumed permissible current changes with respect to the given sinusoidal waveform. Amplitudes of higher harmonics can be reduced by decreasing the ΔI value but then the switching frequency of the PWM rectifier transistors increases. A more advantageous spectrum of current harmonics occurs when the PWM rectifier operates with the use of the PWM method, but then the

PM generator currents can not be adjusted directly. Therefore, before choosing one of the transistor switching methods it is necessary to compare the THD factors for similar working conditions.

References

- [1] J. BAROUDI, V. DINAHAHI and A. KNIGHT: A review of power converters topologies for wind generators. *Renewable Energy*, **32**(14), (2007), 2369-2385.
- [2] Y. DANILEVICZ, P. DROZDOWSKI, W. MAZGAJ, T. SOBCZYK and Z. SZULAR: The influence of failures of a multiphase PM synchronous generator and a static voltage converter system on the generator electromagnetic torque. *Proc. PowerTech 2005 Conf.*, Sankt Petersburg, Russia, (2005), paper no. 520.
- [3] W. MAZGAJ, Z. SZULAR, T. WĘGIEL and T. SOBCZYK: Small hydropower plant with variable speed PM generator. *Przełąd Elektrotechniczny*, **87**(5), 2011, 282-287.
- [4] M. RASHID: *Power Electronics Handbook*. 3rd Edition, Butterworth-Heinemann, Burlington (USA), Oxford (UK), 2010.
- [5] T. SOBCZYK, W. MAZGAJ, Z. SZULAR and T. WĘGIEL: Energy conversion in small water plants with variable speed PM generator. *Archives of Electrical Engineering*, **60**(2), 2011, 159-168.
- [6] T. SOBCZYK, W. MAZGAJ, Z. SZULAR and T. WĘGIEL: Higher harmonics of converter currents in energy conversion system of small water plants. *Proc. 20th IEEE Int. Symp. on Industrial Electronics*, Gdańsk, Poland, 27-30 June 2011.