

## SMART GRID CONDITION ASSESSMENT: CONCEPTS, BENEFITS, AND DEVELOPMENTS\*

SHADY S. REFAAT, HAITHAM ABU-RUB

Texas A&M University at Qatar, Doha, Qatar,  
e-mail: shadysamir@ieee.org, haitham.abu-rub@qatar.tamu.edu

**Abstract:** Power delivery infrastructures are overstrained and suffer from overaged conditions, not only in the developed, but also in the more industrialized countries. The aim of the smart grid is to provide a more reliable and efficient electric power grid. Condition assessment is an essential and effective part of the reliability for electric grid components; also, it reflects the physical state of the electricity asset in a generation, transmission, distribution, and consumers sides. In this paper, condition assessment of electric grid assets will be discussed and illustrated within the context of smart grid principle. In addition, the proposed condition assessment architecture and the objective of condition assessment for smart grid equipment will be explored and analyzed. Moreover, the potential benefits of such smart system as compared to the traditional power system will be presented. This paper aims to add significant contribution to a smart grid theory.

**Keywords:** *condition assessment, smart grid, electric grid reliability, smart grid reliability*

### 1. INTRODUCTION

Traditional grids are one-way electricity flow while smart grid (SG) is a two-way flow of electricity and digital information in order to efficiently and reliably control various appliances at consumers side [1]. There are many major differences between smart grids and conventional power grids [2]–[5]. Traditional grid is based on a one-way blind network. The smart grid principle is rather based on a hierarchical structure and on the acceptability of intermittent resources such as renewable energies. SG acceptability of the choppy different renewable energy sources and its power outage self-healing capability are the major advantages over traditional power grid. Electric power grid includes three main generation systems with similar assets; systems that are responsible for the production of electricity from fossil fuel, renewable energy sources such as solar and wind, and nuclear power through centralized power plants that may include generators, diesel engines, gas turbines, step-up power transformers,

---

\* Manuscript received: September 12, 2016; accepted: December 29, 2016.

motors, compressors, pumps, switchgear equipment, etc. Smart grid enhancements include various technologies used to improve the stability and reliability of the generation in addition to intelligent controls and generation mix consisting of various renewable energy resources.

Transmission system is responsible for transmitting generated electrical energy from generation sources to the distribution system, which may include overhead lines and underground cables. Intelligent transmission systems include a smart and intelligent network, self-monitoring and self-healing capability, and the adaptability and predictability of generation and demand that is robust enough to handle congestion, instability, and reliability issues.

Distribution system transmits electricity from the transmission side to different end-use sectors (e.g., residential, commercial, industrial, etc.). This system may include smart meters, switchgears, cables, switches, fuses, isolators, circuit breakers, relays, control panels in addition to energy storage technologies. Energy storage systems may include pumped hydro, advance batteries, flow batteries, compressed air, super-conducting magnetic energy storage, super-capacitors, and flywheels.

In spite of the fact that these grid networks may be running for decades without significant changes on its infrastructure, there are different components that degrade with time and operating stress. Such grid experiences an inability when the demand for power delivery and consumption boosts, which happens frequently in recent years. The main reason that acts on the decrease of efficiency in traditional power grid is the lack of information exchange [6]. Most power devices still operate in an isolated manner while their operation principle is based on electrical properties rather than on information exchange, which makes traditional power grid fragile. Much of this progressive deterioration can be specified by condition assessment system to enable life-extending intervention, increase electrical power maneuvering capability, increase power grid reliability, and reduce electrical equipment outages and unscheduled downtime.

Reliability is a measure of the system ability to provide a regular and continuous service for particular time [7]. The need for increased reliability and optimum economic performance of smart grid has become of greater importance in recent years. A major factor in achieving these objectives is a provision of efficient condition assessment of the wide range of equipment. Unfortunately, condition assessment of all electrical equipment in grid network has received relatively little attention in the research community.

Some authors attempted to monitor changes in many components and rate the deterioration stage of electrical grid equipment [8]–[26]. Several of these assessment condition techniques are focused on insulation materials of: different electric grid components [8]–[10], generators [11]–[13], power transformers [14]–[16], underground power cables [17], [18], circuit breaker [19], [20], switchgear [21], relays [22], and motors [23]–[25]. These studies show one fact: when any equipment of traditional power grid infrastructure is degraded beyond the point of economical repair or replacement, the grid

economic life ends. Although there exist a monitor and a control for the network which is built above the traditional power grid, most power devices still operate in an isolated manner and their operation is based on electrical properties rather than on information exchange. For example, a relay makes the decision to open a circuit breaker only when the detected current on a feeder exceeds the threshold. It neither tells other relays its own status nor takes information from other relays to help itself make a decision. Therefore, it is too late in many situations to take action when there is a noticeable physical change. The smart grid has an ability to improve safety and efficiency by making better use of existing assets; it enhances reliability and power quality, reduces dependence on imported energy, and minimizes environmental impacts. Condition assessment in smart grid could be the first step in a more formal asset management system, which allows utilities to reflect the physical state of different electric grid equipment, estimates remaining useful time of the electrical equipment for a more reliable smart grid, and identifies future maintenance requirements. It also provides an analysis of functional and physical deficiencies of electrical equipment for equipment replacement program and for making timely decisions about electrical equipment rehabilitation.

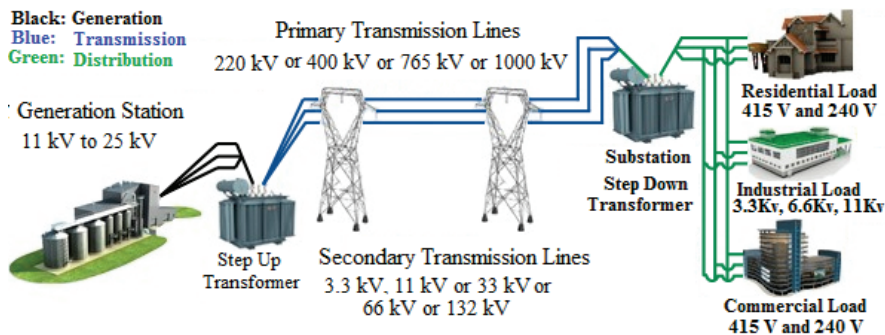

Fig. 1. General Electricity Delivery System; generation, transmission and distribution

All the aforementioned benefits show that condition assessment is a crucial step to improve smart grid elements reliability and stability across various sectors.

The main contribution of this paper is presentation of the benefits of implementing condition assessment system as a crucial step to improve smart grid reliability and stability across the three key area of the electrical grid (generation, transmission, distribution) as depicted in Fig .1.

## 2. CONDITION ASSESSMENT CONCEPT

Condition assessment reflects the physical state of the electric grid equipment, which may significantly affect its performance. The performance of the grid equip-

ment is the ability to provide the required level of service to customers. Generally, this can be measured by identifying system reliability, availability, capacity, and equipment criticality. Condition assessment provides information about equipment technical details, collected data analysis, maintenance history, repair, and replacement. All of this is considered as essential information for extending the remaining useful life of electrical grid equipment and more importantly for the timely intervention steps to bring beneficial levels of service. Condition assessment system of smart grid contains equipment assessment along with their current condition, the useful lifetime of that equipment, permanent monitoring of the grid component, planning, designing, operation, and maintenance programs. Implementing condition assessment to the smart grid one achieves several potential benefits, that are driving newfound interest. Condition assessment results in the following:

- Develop; assist the maintenance, replacement and renewal strategy of the electrical equipment in a smart grid.
- Online monitoring of the physical state of electrical grid equipment.
- Provide an early indication of faults, diagnose problems, failure production.
- Determine whether the grid equipment is in a suitable operation condition.
- Obtain reference results to assist in the diagnostic tests of electrical machines after failure.

The proposed condition assessment process consists of five major stages as shown in Fig. 2. Each stage is described briefly in this section.

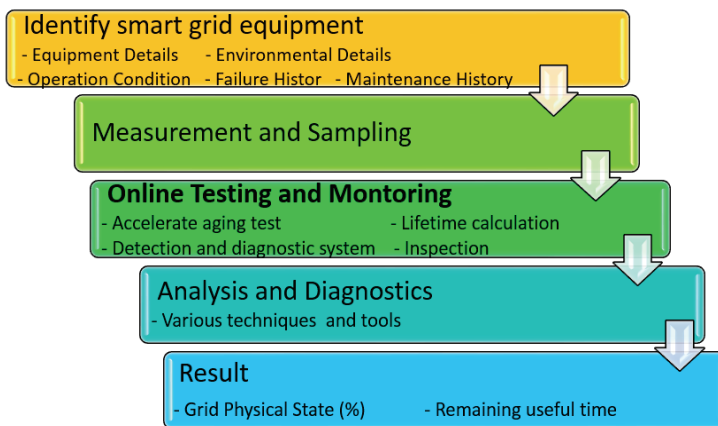

Fig. 2. The power grid condition assessment stages

### 2.1. IDENTIFYING SMART GRID EQUIPMENT

It is important to identify equipment technical details, i.e., rated power, age, material, installation, operating modes, protection, maintenance history, i.e., routine re-

pairs, overhauls, lubrication, downtimes, equipment failures; environmental details, i.e., indoor, outdoor, contamination rates, high humidity, aggressive chemicals, and ambient stress; critical equipment as well as the critical failure modes. Critical equipment is defined as that having high consequence of failure such as:

- Structural: where the physical condition of the equipment is the measure of deterioration.
- Capacity/utilization: where it is necessary to understand the level of under or overcapacity against the required level of service to establish remaining life or timing for renewal.
- Level of service failures: e.g., reliability and image, where performance targets are not achieved
- Obsolescence: technological change or lack of replacement parts can render assets uneconomical to operate or maintain.

Understanding the above points about the grid equipment will help to plan for the probabilities and impacts of an event.

## 2.2. MEASUREMENT AND SAMPLING

Condition assessment and performance monitoring involve inspection of equipment, either fully or by way of appropriate sampling. Accuracy in measurement and sampling in data is the opportunity for ongoing improvement on condition assessment program toward a smart grid solution. The idea behind the “smart grid” is that the grid will respond to real-time demand; in order to do this, it will require sensors to provide this “real-time” information. During the last few decades, a wide variety of sensors and measurement appliances have been developed for measurement and monitoring of power grid, including electrical (e.g., partial discharge), mechanical (e.g., vibration), thermal (e.g., temperature), and chemical (e.g., acidity in oil). Sensors are input devices that convert physical stimulus into an electrical signal. Smart grid sensors are used to monitor and control different assets in smart grid. Sensor types of smart grid are: light, temperature, current, voltage, heat, speed, strain, image, motion, magnetism, pressure, position, and airflow, as shown in Fig. 3. The data acquisition process is typically designed to integrate data collected from analysers, smart meter, smart appliances, renewable energy resources, and energy efficiency resources. Smart grid to reach its potential, needs to respond to real-time demand. Sensors will be a key enabler for the smart grid to reach such potential. The recorded measurements can be stored as reference information (fingerprints) for later comparison with repeated measurements. The aging process and identification of new damage can thus be assessed and recorded. Smart grid sensors are generating a huge volume of different variety of data sets, so called big data. Data from sensors could alert substation operators to abnormal conditions that might point to problems in the power grid, help improving the reliability and resiliency of electric grid, and optimize the asset man-

agement and operating costs. Big data can be divided into three main areas. **Visualization** which represents accurate distribution grid connectivity information, accurate meters data, energy storage information, and cyber security data. Visualization helps condition assessment program perform analyses and make decisions much faster and better. **Situational awareness** represents demand response and distributed generation contributions, grid management reliability, and system resiliency. **Predictive forecasting** represents wide area of situational awareness, system protection and restoration, and grid security information.

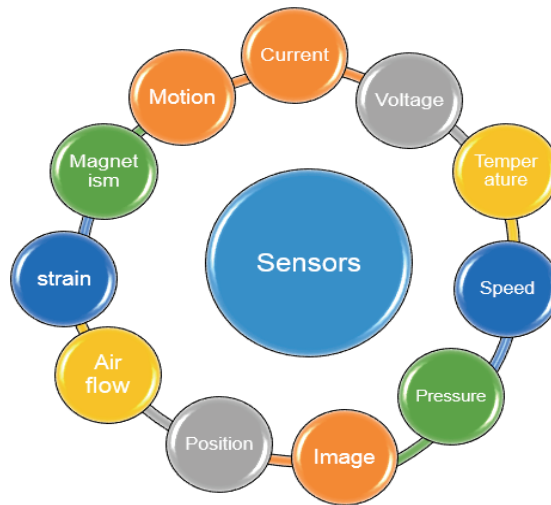

Fig. 3. Sensor types in smart grid

Processing and analyzing these big data reveals deeper insights that can help to improve the operation of power grid, achieve better performance, improve decision making, integrate legacy systems for improved data flow. The challenges are present in increasing volumes of data and accessing the level of details needed; all at high speed. Moreover, it takes a lot of understanding efforts to get the data in the right shape so that one can use visualisation as part of data analysis. Even if data is analyzed quickly and put in the proper context, the value of data for decision-making and assessment purposes will be useless if the data is not accurate or complete.

### 2.3. TESTING AND MONITORING

Condition assessment performance is precursors to determining the optimal level of maintenance that should be carried out to ensure equipment delivery of standard of service required. A major challenge for the technique is striking the right balance of planned maintenance (inspections, scheduled maintenance, etc.) and unplanned

maintenance (arising from unexpected failures). Implementation of these strategies will require an inspection for the cause of previous failures and their impacts. Furthermore, the probability of failure and its criticality, and lifetime calculation in addition to the accelerate age test and monitoring will be needed. The testing and monitoring methods are divided into two types: offline-monitoring, which requires disconnecting the equipment from service for testing and an online monitoring, which can be implemented for operating equipment. Both methods are intrusive or non-intrusive to the equipment operation. Offline testing is commonly more direct and more accurate, but requires higher costs. Online testing techniques include: (i) frequency domain measurements of: dissipation factor, complex capacitance, and permittivity of the equipment insulation, and (ii) time domain measurement techniques such as return voltage measurement (RVM), the polarization and depolarization current (PDC) measurements. The online methods can provide not exact, but sufficient, relevant information about the physical state of the equipment with lower cost.

#### 2.4. ANALYSIS AND DIAGNOSTIC

When a large quantity of data is collected from monitoring, the useful information about defects and their severity may be hard to find. It is important to analyze and diagnose the data intelligently. Different types of diagnostic techniques may be employed; online diagnosis is used to provide a quick diagnose in case of material degradation and off-line diagnosis is used periodically to determine the exact cause and location using trend analysis, phase comparison, digital signal processing, and artifi-

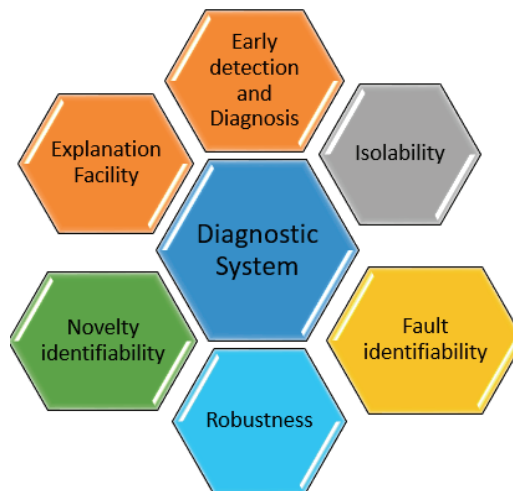

Fig. 4. Attributes of diagnostic system

cial intelligence techniques [26], [27]. Failure investigations should be carried out using a structured and systematic approach. Honest and objective appraisal is necessary. An in-depth examination may help to determine whether a failure is an isolated case or is due to a type of fault that may affect other equipment [28], [29]. The objective of the analysis and diagnostic testing is to identify defects that result in equipment degradation and predict the time required for overcoming these defects. The analysis and diagnostic stage has significant attributes, such as early detection and diagnosis, isolability, fault identifiability, robustness, novelty identifiability, explanation facility, and adaptability, as shown in Fig. 4 [30].

**Adaptability** is the ability of the system to adapt any environmental changes and disturbances due to operating conditions. **Novelty identifiability** is the ability of the system to detect novel faults (relatively easy to achieve) and to identify and isolate faults (extremely difficult to accomplish). **Explanation facility** refers to diagnostic system that has to explain and diagnose the place of fault and how it can be propagated. **Robustness** is essentially the measure of disturbance and modeling uncertainty in practical implementation. **Fault identifiability** is the ability of the system to identify the type or the nature of the fault; fault identification in accurate way is very difficult to achieve due to system disturbance and measurement noise. **Isolability** refers to the capability of a diagnostic system in distinguishing the points of the fault or determine the faulty components. Isolation capability depends on the way the fault affects a system. It is a serious challenge to achieve high degree of isolability. **Early detection and diagnosis** is the ability of a diagnostic system to detect and isolate the incipient faults.

## 2.5. RESULTS

Condition monitoring provides information that is essential to enable network operation to identify imminent failures and assess real time condition. With the communication of the data acquisition and processing system, the measurable data can be processed automatically while any failure can be diagnosed intelligently. Figure 5 shows the proposed condition assessment framework in detail beginning from collecting all physical parameters information. A series of sensors provide the monitoring unit with information on key parameters necessary to process all the available information and make a report to help in diagnosing and classifying the failures. The collected data is processed using real-time signal processing for having data update in the main control center and providing update maintenance patch notes.

In the future, smart grid equipment will be able to form electrical cooperative communities. Such communities will be able to take the role of electric power manoeuvring with another grid equipment for continuous electricity supply. It is expected that SGs can also form a network to maximize the utilization of renewable energy resources.



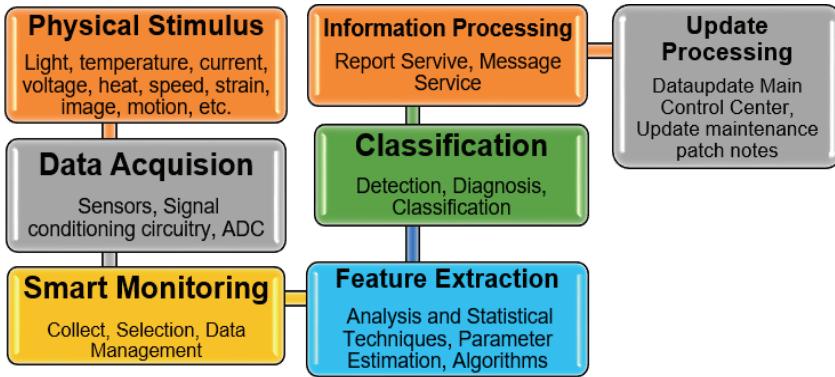

Fig. 5. Proposed condition assessment framework

### 3. SMART GRID CONDITION ASSESSMENT ARCHITECTURE

The architecture of a condition assessment specifies the arrangement of the smart grid components and analyzes the performance of each part. The proposed condition assessment architecture is composed of two modules. The first module gathers maintenance strategies of the grid components. The second one is a detection and diagnosis module, which aims to detect the occurrence of drifts from the known and unknown failure modes for determining the current state of the process. In this case, it will be necessary to update the database of the system, and to give information to the supervisor of the process in order to reactualize the dysfunctional analysis. This analysis is realized according to expert knowledge on the process and other information about the process. Figure 6 shows that condition assessment is conducted based on the equipment monitoring, e.g., physical state, inspection, downtime pre-

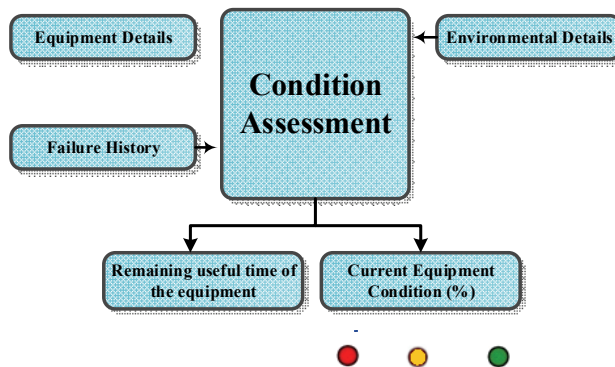

Fig. 6. Condition assessment architecture

vention, maintenance planning, failure production, performance monitoring, and equipment calibration. All this information is used to perform the detection and diagnosis functions and finally to detail the general scheme of the condition monitoring.

#### 4. CONDITION ASSESSMENT MODEL

Smart grid allows for greater possibility of energy delivery and power flows. It enables two-way flow of electricity and digital information between utilities and customers. Such grid is supported by smart meters, sensors, detectors, measurement units, etc. Those elements may provide a continuous stream of data to support awareness of smart grid performance characteristics and physical state. Today, there is still no reliable and convenient methodology for online condition and aging assessment of electric equipment in smart grid [31]. The most significant challenge to smart grid condition assessment is the quantification of information on the physical layer of different electric grid equipment through the development of technologies toward objective and accurate condition assessment for reliable evaluation. In addition, a number of problems still do exist in terms of practical application.

The smart grid includes many electric equipment on generation, transmission, distribution, and consumers sides. Transformer is an essential equipment in all electrical grids. It is the heart of electric utility and smart grid system. In this work, a case study is discussed on a large power transformer condition assessment for the smart grid. Several condition assessments of electric grid machine are based on current signature analysis [32], vibration analysis [33], dissolved gas analysis [34], furan analysis [35], degree of polymerization [36], temperature analysis, and field analysis [37]. Recently, new techniques based on artificial intelligence (AI) approaches have been introduced using concepts such as fuzzy logic [38] and neural network [39], [40]. The condition assessment model focuses on the fundamental frequency component to evaluate the condition of electric machine online [41]–[43]. The core vibration amplitude is proportional to the squared value of terminal voltage and the square value of current, respectively [44].

$$\alpha_{core} \propto U^2, \quad (1)$$

$$F(t) \propto I^2, \quad \alpha_{winding} \propto I^2. \quad (2)$$

The winding vibration variation could be given by

$$\Delta w = \sqrt{\alpha_1^2 + \alpha_2^2 - 2\alpha_1\alpha_2 \cos \beta} \quad (3)$$

where  $\alpha_1$ ,  $\alpha_2$  are the total vibrations Magnitudes under different loads and  $\beta$  is the phase angle between the total vibrations. As the core vibration is extremely small,

short time interval between two samples of the total vibration changes is little, and consequently the angle  $\beta$  is small. The winding vibration variation may be written as

$$\Delta w = |\alpha_2 - \alpha_1|, \quad (4)$$

the winding vibration variations are calculated for each sensor.  $\Delta\omega_{ij}$  is the result of the  $j$ -th sensor obtained from the  $i$ -th and the  $(i + 1)$ -th core vibration samples of power transformer in the grid. The winding vibration variations from all sensors are proportional to the current squared variation

$$\Delta\omega_{ij} \propto (I_{i+1}^2 - I_i^2). \quad (5)$$

The selection of the feature extraction method that permits an effective characterization of the sensors plays a crucial role for condition assessment in terms of reliability and accuracy. In [40], principal component analysis (PCA) is used to analyze the vibration variations from different sensors in the core of the transformer to build the matrix and determine sampling rates of the sensors

$$W = \begin{pmatrix} \Delta w_{11} & \dots & \Delta w_{1m} \\ \vdots & \ddots & \vdots \\ \Delta w_{n1} & \dots & \Delta w_{nm} \end{pmatrix}. \quad (6)$$

The first step of condition assessment model is to obtain the covariance matrix. The normalized vibration variation matrix  $X$  in the PCA model could be given by

$$X = \begin{bmatrix} x_1^T \\ \vdots \\ x_n^T \end{bmatrix} \in R^{n \times m}, \quad x_i = \begin{bmatrix} x_{i1} \\ \vdots \\ x_{im} \end{bmatrix}, \quad (7)$$

the covariance matrix is decomposed as

$$C_{xx} = \frac{1}{m-1} X^T X = U \Lambda U^T \quad (8)$$

where the columns of  $U$  are the eigenvectors, and they are also known as PCs.  $\Lambda = \text{diag}\{\lambda_1 \lambda_2 \dots \lambda_m\}$  contains eigenvalues in descending order of magnitude  $\lambda_1 \geq \lambda_2 \geq \dots \geq \lambda_m$ .

Only one main principal component exists after PCA transformation. Main principal contribution (MPC) is used as parameter and given by

$$MPC = \lambda_1 / \sum_{i=1}^m \lambda_i. \quad (9)$$

The degree of the winding vibration variation from different sensors provides the monitoring unit with the deviation level. The MPC value moves closer to 0, which means that the condition of the transformer had been affected. If it is close to 1, it means that the winding vibrations from different sensors follow the same rule. According to this, the available information is beneficial to make a report to help in diagnosing, classifying and assessment of the transformer performance characteristics and physical state. The steps are normally linked together in order to collect the data and process it using real-time signal processing for having real data update in the main control center and for providing updated maintenance patch notes.

### A CASE STUDY OF ONLINE CONDITION ASSESSMENT OF ELECTRICAL MOTOR FOR INCIPIENT FAULTS DETECTION

There are many types of techniques that can be used for condition assessment of electrical machine as mentioned previously. Another case study is discussed in this section to demonstrate the online condition assessment for incipient faults detection in smart grid. In this study, the condition assessment model focuses on the fundamental frequency component to online evaluate the condition of electric motor as given in [42], [43]. Hence, to achieve long life of motor, it is necessary to monitor the condition of insulation frequently. Condition assessment increases the motor reliability and lifetime by making proactive decisions in case of incipient fault. It also reduces the maintenance cost of the system. Incipient stator winding fault has been considered the most challenging fault type. In this investigation, it is found that the magnitude of the stator current harmonics changes after the occurrence of stator turn fault. Characteristics analysis of stator line currents with stator turn faults, using the developed simulation model in [42], reveals that winding inter turn fault causes a significant increase in the fundamental component and odd harmonic values of stator line currents compared to healthy situation, as shown in Fig. 7. The ratio of third harmonic to fundamental FFT magnitude components versus different percentages of stator turn faults at different load conditions is approximately linear with the fault severity and inversely proportional with loading condition. This ratio could be used as a reliable indicator for assessment of machine stator winding which may help in preventing unexpected shutdowns of machine in smart grid. Simulation investigation has been carried out using MATLAB/SIMULINK® to verify the performance of the proposed technique. In order to validate the simulation results, a series of experiments were conducted for the assessment of motor stator windings. The machine used in the test is three-phase, 50 Hz, 2-pole, 2.2 kW, squirrel cage induction motor with several taps on each phase. The taps are provided approximately a 1, 2 or 3% of the stator turns that can be shorted to create the fault at any phase. The stator current and voltage signals are provided to the Data Acquisition Card (DAQ) which acquires the data for processing at a sampling rate of 12 kHz.

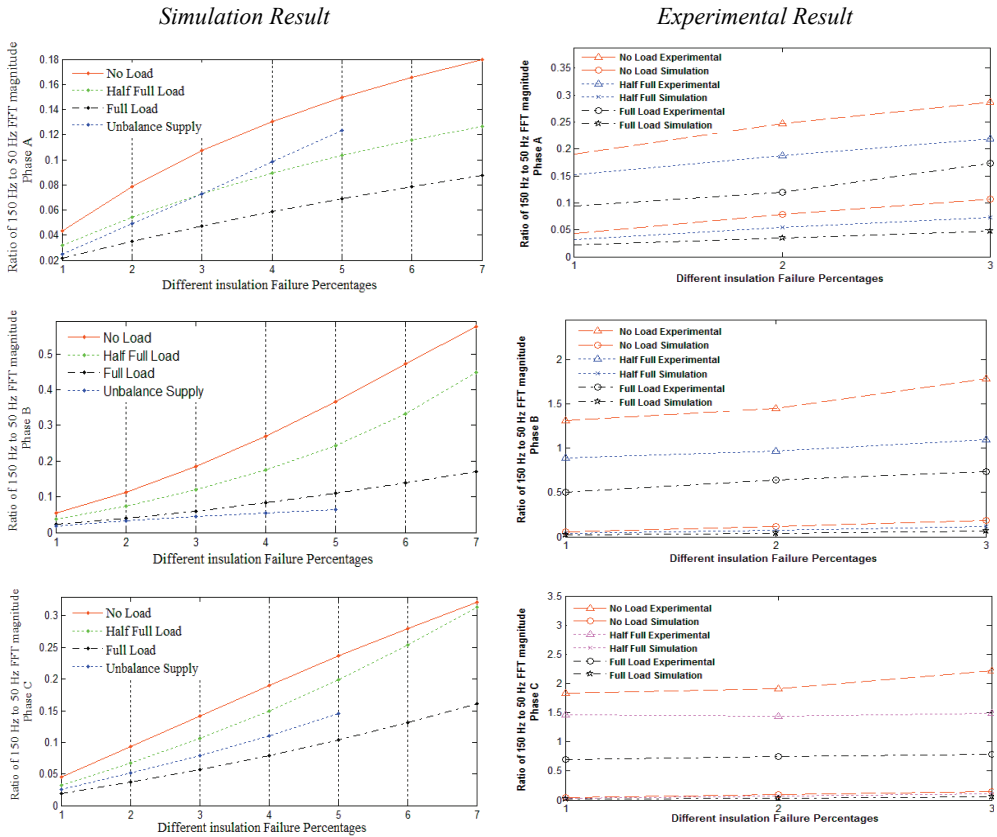

Fig. 7. Simulation and experimental results – ratio of third harmonic to fundamental FFT magnitude components versus different percentages of a fault for: (a) phase (A); (b) phase (B); (c) phase (C)

Once the three-phase stator currents acquisition is completed, the program is used to process and analyse the obtained data. The results of experimental investigations are compared with the simulation ones as shown in Figs. 7a,b,c. The simulation results match with the experimental. The scheme is capable to assess motor winding and identify the severity level of the incipient fault. The correctness of the condition assessment scheme is achieved, which proves the validity of the proposed approach.

## 5. EXPECTED POTENTIAL BENEFITS OF CONDITION ASSESSMENT FOR SMART GRID

Reliability of the whole grid can be highly improved by the implementation of adequate condition assessment system in smart grid. The benefits obtained from con-

dition assessment of electric power networks are divided into two types, direct benefits and indirect benefits. The direct benefits are the following:

- Improve different electricity systems reliability, higher asset utilization.
- Increase equipment efficiency.
- Improve maintenance procedures and extending service life.
- Provide an opportunity for a planned shutdown for correction of the problem before failure.
- Condition status and availability of facility records.
- Reduce the overall operating cost, while boosting the productivity of the plant.
- Reduce outage duration.
- Avoidance of premature asset fault.

The indirect benefits of the condition assessment include: reduction of overall expenses, decreasing the risk of premature failure, increasing the reliability of electric grid components, and providing an excellent opportunity for improving both energy efficiency and reducing production cost. The benefits also include an improved approach to enhance power grid maintenance strategy. This helps to increase the availability of electric grid components, and to minimize the possibility of catastrophic events occurring.

Cost-benefit analysis of condition assessment of electric equipment in smart grid directly compares benefits and costs. Calculation of the cost of electric equipment in smart grid includes operations, installation, maintenance and repair costs. The condition assessment benefits of electric equipment are made based on the following definitions [45]:

*Risk = Probability of occurrence of an event X Consequently of this event*

*Benefit = Risk with out assessment – Risk with assessment*

The costs of condition assessment system often appear to be high because equipment is massive, not accessible, and difficult to examine. But, the most recognized benefit of condition assessment is the major savings that can be achieved on repair costs and on increasing electrical power maneuvering capability. In addition, the cost benefits of condition assessment are high compared with the expenses that could result in sudden equipment failure or in unscheduled outages.

## 6. CONCLUSION

In this paper, there was presented possible future direction in electrical smart grid. A smart grid condition assessment system was introduced through three main areas of electrical grid; generation, transmission and distribution. The presented system is essential for a robust and reliable smart grid. The presented idea is crucial for more reli-

able smart grid. It increases the reliability, safety, and lifetime of the grid equipment and components. It presents a timely and effective maintenance that is based on accurate inspection and good knowledge of equipment condition. The proposed solution can reflect the physical state of the electric grid equipment, which positively affects its performance, function monitoring, and the health of grid devices. The solution provides outage detection and power quality disturbance identification. This system does not require any change in the smart grid infrastructure. Smart grid condition assessment vision is expected to be a critical part of the future smart grid management systems.

#### ACKNOWLEDGMENTS

This publication was made possible by NPRP grant (NPRP 7-106-2-053) from the Qatar National Research Fund (a member of Qatar Foundation). The statements made herein are solely the responsibility of the authors.

#### REFERENCES

- [1] FANG X., MISRA S., XUE G., YANG D., *Smart grid – the new and improved power grid: A survey*, IEEE Commun. Surveys Tutorials, 2012.
- [2] BAYINDIR R., HOSSAIN E., VADI S., *The path of the smart grid -the new and improved power grid*, International Smart Grid Workshop and Certificate Program (ISGWCP), 2016, 1–8.
- [3] FARHANGI H., *The path of the smart grid*, IEEE Transactions on Power and Energy, 2010, 8, 1, 18–28.
- [4] ZHOU X., *Development prospects of power grid and power system technology in changes with renewable energy*, Huadian Technology, 2011, 33, 12, 1–3.
- [5] ZHOU, JINJU, LINA HE, CANBING LI, YIJIA CAO, XUBIN LIU, YINGHUI GENG, *What's the difference between traditional power grid and smart grid? – From dispatching perspective*, IEEE PES Asia-Pacific in Power and Energy Engineering Conference (APPEEC), 2013, 1–6.
- [6] WEI M., WANG W., *Greenbench: A benchmark for observing power grid vulnerability under data-centric threats*, INFOCOM, 2014.
- [7] DUBROVA E., *Fault-Tolerant Design*, Springer, 2013, 5–20.
- [8] OKUBO H., *Enhancement of electrical insulation performance in power equipment based on dielectric material techniques*, IEEE Conference on Electrical Insulation and Dielectric Phenomena, Cancun, Mexico, 2011, 1–19.
- [9] HAN J., MERTE R., HERMAN H., *Condition assessment of epoxy-impregnated insulating materials*, Conference Record of the 2010 IEEE International Symposium on Electrical Insulation (ISEI), 2010, 1–4
- [10] BAIRD P.J., HERMAN H., STEVENS G.C., *Rapid Non-Destructive Condition Assessment of Insulating Materials*, IEEE International Symposium on Electrical Insulation, ISEI 2008., 2008, 742–745.
- [11] NARANPANAWA W.M.L.B., RATHNAYAKE R.M.H.M., FERNANDO M.A.R.M., JAYANTHA G.A., *Condition assessment of generator stator insulation by DC ramp and IR tests*, IEEE International Conference on the Industrial and Information Systems (ICIIS), 2013.
- [12] FARAHANI M., BORSI H., GOCKENBACH E., *Dielectric Response Studies on Insulating System of High Voltage Rotating Machines*, IEEE Transactions on Dielectrics and Electrical Insulation, 2006, 13, 1, 383–393.

- [13] PENG S., JIAN L., YUANHONG W., YONGLONG Y., TIANYAN J., *Condition assessment of wind turbine generators based on cloud model*, IEEE International Conference on Solid Dielectrics (ICSD), 2013, 146–151.
- [14] WANG, SONG, XIANG-LONG LI, JUN-HAO LI, XIAO-HUI ZHAO, YAN-MING L.I., *Experimental Study for Outside Propagation Characteristic of the UHF Signal Emitted by Partial Discharge in Transformers*, Electrical Insulation Conference (EIC), 2014, 286–289.
- [15] MIRZAIIE M., GHOLAMI A., TAYEBI H.R., *Insulation Condition Assessment of Power Transformers Using Accelerated Ageing Tests*, Turkish Journal of Electrical Engineering and Computer Sciences, 2009, 17, 1, 39–54.
- [16] WANG M., VANDERMAAR A.J., *Review of condition assessment of power transformers in service*, IEEE Electr. Insul. Mag., 2002, 18, 5, 8–17.
- [17] HALIM H.S.A., GHOSH P., *Condition assessment of medium voltage underground PILC cables using partial discharge mapping and polarization index test results*, IEEE International Symposium on Electrical Insulation Conference, 2008, 32–35.
- [18] ANANDAKUMARAN K., SEIDL N., CASTALDO P.V., *Condition assessment of cable insulation systems in operating nuclear power plants*, IEEE Transactions on Dielectrics and Electrical Insulation, 1999, 6, 3, 376–384.
- [19] LAULETTA J.L., SOZER Y., DE ABREU-GARCIA J.A., *A novel sensing device for underground cable condition assessment*, IEEE Electrical Insulation Conference (EIC), 2015, 523–528.
- [20] STEPHEN B., STRACHAN S.M., MCARTHUR S.D.J., McDONALD J.R., HAMILTON K., *Design of trip current monitoring system for circuit breaker condition assessment*, IET Generation, Transmission & Distribution 1, 2007, 1, 89–95.
- [21] BEATTIE S., *Circuit breaker condition assessment by vibration and trip coil analysis*, IEEE Colloq. Monitors and Condition Assessment Equipment Digest, 1996, 186.
- [22] DONGMEI Z., WEICHEN L., XU Z., *Relay protection condition assessment based on variable weight fuzzy synthetic evaluation*, IEEE Conference on Technologies for Sustainability (SusTech), 2014, 115–120.
- [23] STONE G.C., LLOYD B.A., CAMPBELL S.R., *On-line monitoring for condition assessment of motor and generator stator windings*, IEEE on Pulp and Paper Industry Technical Conference, 1994, 94–103.
- [24] LLOYD B.A., STONE G.C., STEIN J., *Motor insulation condition assessment using expert systems software*, IEEE Pulp and Paper Industry Technical Conference, 1994, 60–67.
- [25] KUUSIK A., NOMM S., OVSJANSKI S., ORUNURM L., REILENT E., *Wearable system for patient motor condition assessment and training monitoring*, IEEE on Point-of-Care Healthcare Technologies (PHT), 2013, 192–195.
- [26] SU Q., *Insulation condition monitoring of electrical plant – How to interpret the collected data and diagnose incipient faults*, Keynote speech in International Conference on Machines, 2009, 12–20.
- [27] SU Q., MI C., LAI L.L., AUSTIN P., *A fuzzy dissolved gas analysis method for the diagnosis of multiple incipient faults in a transformer*, IEEE Trans. Power Sys., 2000, 15, 2, 593–598.
- [28] SU C.Q., *Case studies: Lessons learnt from the failure of a new 230kV transformer-cable termination*, IEEE Electr. Insul. Mag., 2010, 26, 1, 15–19.
- [29] SU Q., *Failure analysis of three 230 kV XLPE cables*, in Proceedings of IEEE Transmission and Distribution Conference, 2010, 22–25.
- [30] SOBHANI-TEHRANI, EHSAN, KHASHAYAR KHORASANI, *Fault diagnosis of nonlinear systems using a hybrid approach*, Springer Science & Business Media, 2009, 383.
- [31] GAGE M., *Equipment Maintenance and Replacement Decision Making Processes*, PhD diss., California Polytechnic State University, San Luis Obispo, 2013.
- [32] ARIVAMUDHAN M., SANTHI S., ABIRAMI S., SUGASINI G., *Improved Detection Sensitivity with Combined WPT and HHT for Power Transformer Winding Deformation Analysis*, International Journal of Computer Applications, 2014.



- 
- [33] BEATTIE S., *Circuit breaker condition assessment by vibration and trip coil analysis*, Monitors and Condition Assessment Equipment (Digest No. 1996/186), IEE Colloquium on, 9–1. IET, 1996.
- [34] WANG M., VANDERMAAR A.J., SRIVASTAVA K.D., *Review of condition assessment of power transformers in service*, IEEE Elect. Insul. Mag., 2002, 18, 6, 12–25.
- [35] ZHIMIN HE, YADONG LIU, JING CHEN, WANJIAN BAI, GEHAO SHENG, XIUCHEN JIANG, *A Multi-parameter Comprehensive Analytical Method for Online Assessing Power Transformer Condition*, Przegląd Elektrotechniczny, 2013, 89, 1a, 219–222.
- [36] IEC, IEC 61198 1993-09, Mineral Insulating Oils Methods for the Determination of 2-furfural and Related Compounds, 1993.
- [37] ROBALINO D., *Accurate temperature correction of dissipation factor data for oil-impregnated paper insulation bushings: Field experience*, Electrical Insulation and Dielectric Phenomena (CEIDP), Annual Report Conference on, 2011, 251–254.
- [38] BALZER G., *Condition assessment and reliability centered maintenance of high voltage equipment*, Proceedings of 2005 International Symposium on Electrical Insulating Materials, (ISEIM 2005), 2005, 1, 259–264.
- [39] FENG Q., YONG LIANG LIANG, *Condition assessment of substation equipment based on intelligence information fusion*, IEEE PES Innovative Smart Grid Technologies, 2012, 1–5.
- [40] MEHDI BIGDELI, JAFAR AGHAJANLOO, *Condition assessment of transformer insulation using dielectric frequency response analysis by artificial bee colony algorithm*, Archives of Electrical Engineering, 2016, 65, 1, 45–57.
- [41] HONG, KAIXING, HAI HUANG, JIANPING ZHOU, *Winding condition assessment of power transformer based on vibration correlation*, IEEE Transactions on Power Delivery, 2015, 30, 4, 1735–1742.
- [42] REFAAT SHADY S., ABU-RUB HAITHAM, SAAD M.S., ABOUL-ZAHAB E.M., ATIF IQBAL, *Detection, Diagnoses and Discrimination of Stator Turn to Turn Fault and Unbalanced Supply*, IEEE International Conference on Power and Energy (PECON 2012), 2012, 2–5.
- [43] REFAAT SHADY S., HAITHAM ABU-RUB, SAAD M.S., ABOUL-ZAHAB E.M., ATIF IQBAL, *Discrimination of Stator Winding Turn Fault and Unbalanced Supply Voltage in Permanent Magnet Synchronous Motor Using ANN*, IEEE – Powereng 2013, International Conference on Power Engineering, Energy and Electrical Drives, Turkey, 2013, 858–863.
- [44] GARCIA B., BURGOS J.C., ALONSO Á.M., *Transformer tank vibration modeling as a method of detecting winding deformations – Part I: Theoretical foundation*, IEEE Trans. Power Del., 2006, 21, 1, 157–163.
- [45] SPARLING B.D., AUBIN J., *Power Transformer Life Extension Through Better Monitoring*, General Electric, 2007.