

# INFLUENCE OF NATURAL CONDITIONS ON THE IMAGING OF THE BOTTOM OF THE GDAŃSK BAY BY MEANS OF THE SIDE SCAN SONAR

Dominika Witos-Okrańska<sup>1</sup>

Grażyna Grelowska<sup>1</sup>

Eugeniusz Kozaczka<sup>1,2</sup>

<sup>1</sup> Gdańsk University of Technology, Poland

<sup>2</sup> Polish Naval Academy, Gdynia, Poland

## ABSTRACT

*The interest in underwater resources is the reason for the development of modern hydroacoustic systems, including side sonars, which find numerous applications such as: research of seabed morphology and sediment characteristics, preparation of sea sediment maps, and even in special cases of biocenoses such as sea grass meadows, detection of specific targets at the bottom such as shipwrecks, mines, identification of suitable sites for maritime infrastructure. Such applications require precise information about the position of the objects to be observed. Errors affecting the depiction of the bottom using hydroacoustic systems can be divided into errors associated with improper operation of measuring and support devices, systematic errors and random errors. Systematic errors result from the changing conditions prevailing in the analyzed environment affecting the measurement system. The errors affecting the correct operation of hydroacoustic systems can include: changing angle of inclination of the beam caused by the vessel's movement on the wave or refraction connected to changes in the sound speed as the depth function.*

**Keywords:** side scan sonar imaging, Gdańsk Bay seabed, refraction of sound ray in sea, influence of ship's movement on the wave on underwater imaging

## INTRODUCTION

The basic task of hydroacoustic devices are used to observe the underwater environment [1, 2, 8, 9, 14, 15]. Their basic task is to search, locate and identify objects at the bottom of the sea or in water space. In active systems, the information carrier is an acoustic wave, which is sent towards the bottom, after encountering an obstacle, which may be an object, or the seabed returns to the device as an echo signal. Knowledge of the sound speed propagation of in a water and the measurement of the time from the moment of sending the probe pulse to the moment of receiving the echo impulse makes it possible to determine the depth.

The Baltic Sea is characterized by variable hydrological conditions during the year affecting hydroacoustic conditions

of the basin [3, 6, 7, 10, 12, 13, 19]. Surface water sound speed ranges from 1420 to 1490 m / s during the year. (Fig.1) presents the sound speed distribution for selected months of 2009 for the Gdańsk Deep region. Based on the measurement of salinity, temperature and depth using the Del-Grosso empirical formula [5], the sound speed distribution was determined. The largest differences are observed in the surface layer, because the sound speed is most dependent on the temperature of the water, which changes according to the seasons. Throughout the year, the minimum value of the sound speed occurs in the intermediate layer - an unusual feature of shallow water, then it grows towards the bottom, where it reaches the value of 1450-1460 m / s.

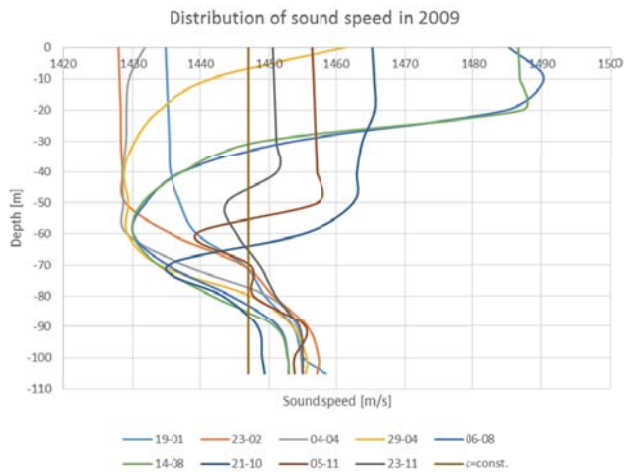

Fig. 1 Statistics of sound speed distribution at the Gdańsk Deep

Nowadays during underwater observation there is a tendency to use a wide beam in order to cover the largest possible bottom surface (multi-beam echo sounder, side scan sonar). Consequently, the beam, or its part, is directed to water at a high angle. Side scan sonars allows to obtain a high distinguishability of objects thanks to a suitably shaped beam, which is very narrow in the horizontal plane (from  $0.5^\circ$  to  $2^\circ$ ), and wide in the vertical plane ( $30^\circ$  -  $75^\circ$ ) (Fig. 2).

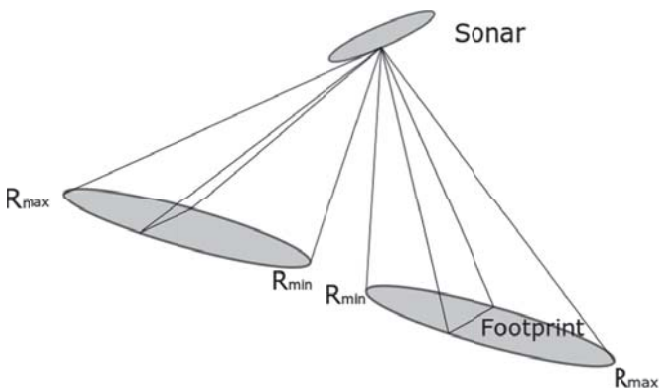

Fig. 2. Side scan sonar beams

The width of the beam depends, among others on the operating frequency of the device. It is connected with on the type of sonar, the resolution that increases with the depth is from about 1 cm to several centimeters (transverse resolution) and from several to several tens of centimeters (longitudinal resolution) [17]. Resolution is not the only parameter determining the accuracy and quality of the mapping. An important role is played by environmental factors such as the spatial distribution of temperature, salinity, water density, which determines the spatial distribution of the sound speed, and consequently the refraction of the acoustic beam. Also the course and speed, as well as the movement caused by the waving of the sea surface of the sonar antenna in relation to the bottom and antenna, distance from the bottom are the factors influencing the quality of sonar data.

The image in the side scan sonar is created by receiving successively sent impulses and connecting them together in

the imaging device [16]. The short pulse length allows for high discrimination (Fig. 3). Thanks to combing the bottom with a narrow impulse, we obtain a high resolution. If in this case we applied a long pulse, we would not be able to distinguish objects on the bottom - only a strong reflection would be visible.

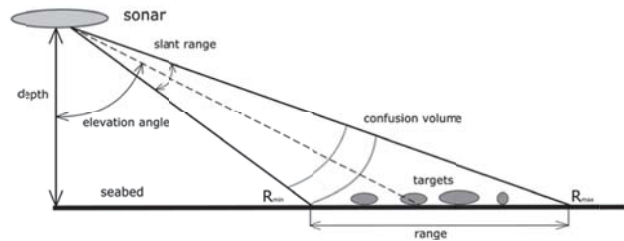

Fig. 3. Creation of seabed image by means of side scan sonar

The quality of the signal is influenced by the shape of the bottom surface and the type and coverage of the sediment. Gas bubbles contained in sediments and the presence of benthos, change the elastic properties of the bottom [18]. Soft acoustic floor - covered with silt disperses less energy, due to lower acoustic impedance. Hard bottom with high acoustic impedance disperses more backward energy. This affects the diversity of the acoustic image for different geological structures (Fig. 4). A brighter image means the occurrence of objects with good acoustic properties, e.g. rock or gravel.

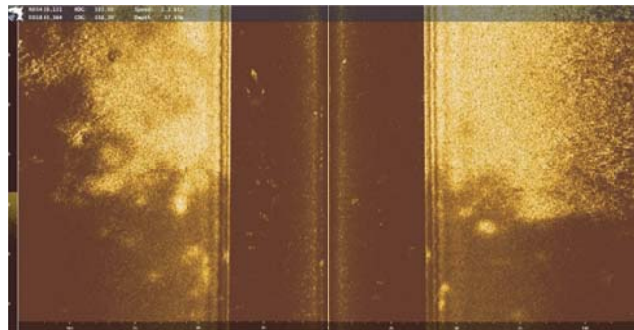

Fig. 4. Change of seabed kind in the vicinity of Hel Peninsula

## REFRACTION OF SOUND BEAM IN REAL SEA CONDITION

Two factors influencing the obtained results will be considered in the article. The first is related to the non-uniform distribution of the sound speed as a function of depth, the second relates to the movements of the measuring ship on the undulated surface of the sea.

Changing the sound speed as a function of depth makes the phenomenon of refraction important in the case of devices using acoustic waves as an information carrier. Refraction affects the accuracy of determining the position of objects when the acoustic wave is radiated to the water at a certain

angle. Snell's laws [11] were used to determine the effect of refraction:

$$\frac{\sin\theta_1}{c_1} = \frac{\sin\theta_2}{c_2} = \frac{\sin\theta_n}{c_n} = \text{const.} \quad (1)$$

where:  $c_1, c_2$  are the values of sound speed in subsequent layers,  $\theta_1$  is the angle of incidence of the beam on the boundary of layers, and the angle  $\theta_2$  is the angle of refraction into the second layer,  $n$  is the number of layers. The water column has been divided into layers characterized by a different value of the sound speed, the number of layers depends on the sound speed distribution. Currently used computational equipment allows the division into any number of layers, which ensures high accuracy.

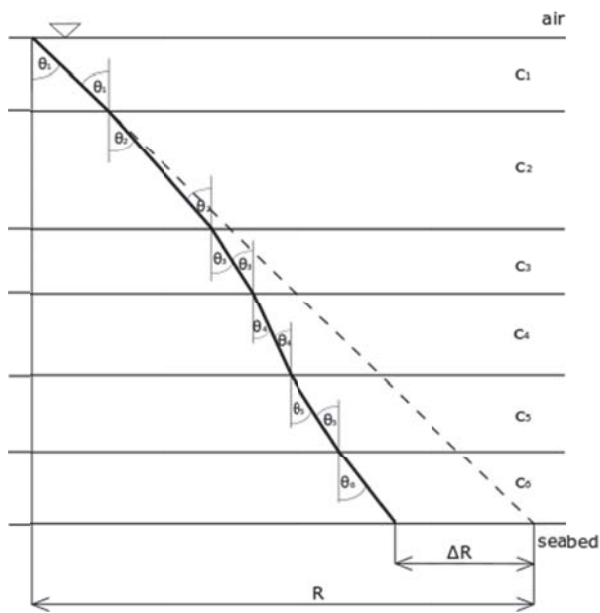

Fig. 5 Refraction of acoustic ray when crossing the boundary of layers with different sound speed

If  $c_1$  is greater than  $c_2$ , the direction of the acoustic wave propagation is altered and the refraction angle will be smaller than the angle of incidence (negative refraction). In contrast, if  $c_1$  is smaller than  $c_2$ , the direction of the acoustic wave propagation is changed and the angle of refraction will be greater than the angle of incident (positive refraction).

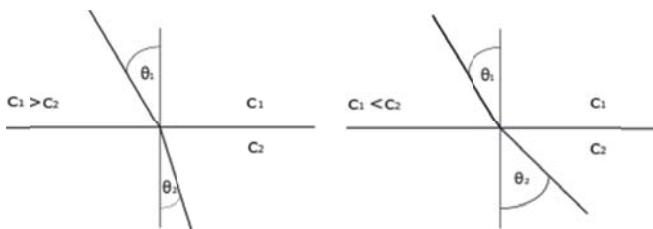

Fig. 6 Refraction principle

The most common assumption in hydroacoustic devices is the uniform distribution of the sound speed. The fact of changing the speed as a function of depth is not taken into account. The graph in (Fig. 7) shows the change in range for internal and external rays of side scan sonar caused by the phenomenon of refraction, assuming that the beam is directed at the angle of 52.5 degree.

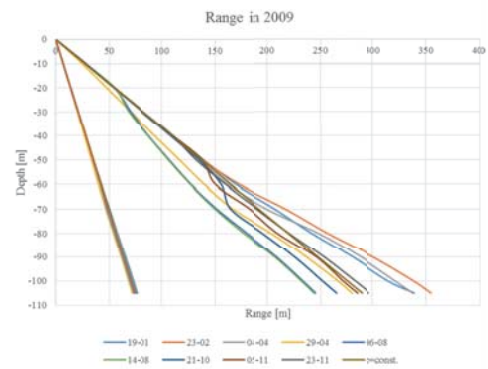

Fig. 7. Side scan sonar range for the speed distribution given at the Fig. 1 ( $\alpha_{min} = 35^\circ, \alpha_{max} = 70^\circ$ )

For the internal radius changes are small, at the bottom of more than 2 meters depending on the regardless of the season (Fig. 8).

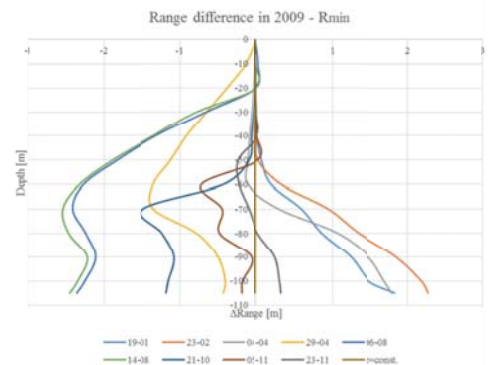

Fig. 8. Range difference for the inner radius of side scan sonar ( $\alpha_{min} = 35^\circ$ )

We observe much greater range differences for the external radius (Fig. 9). The sonar range varies to over 100 meters in a year.

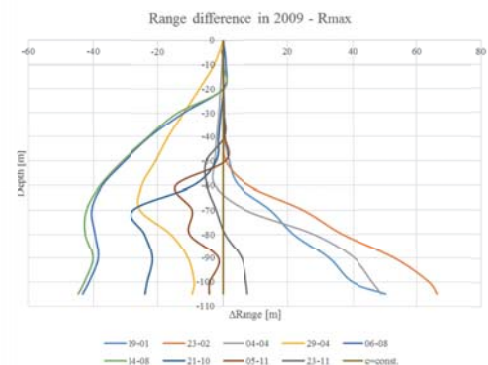

Fig. 9. Range difference for external radius of side scan sonar ( $\alpha_{max} = 70^\circ$ )

A ship moving on a wavy sea has 6 degrees of freedom [4] - three related to a linear shift along the x, y, z axis and three related to the rotation around these axes (Fig. 10).

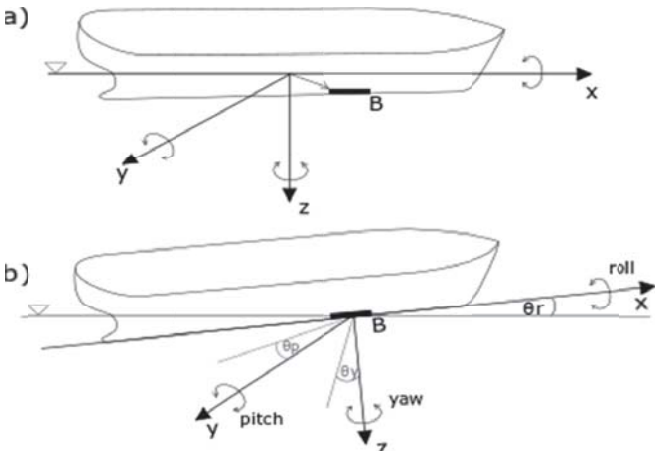

Fig. 10. Ship motions caused by sea surface waving

Movements of the measuring ship cause movement of the sonar transducer mounted to the hull. This affects the intensity and shape of the reflected signals. Transverse and longitudinal swaying of the ship's hull causes changes in the angle of incidence of the acoustic beam, and hence changes in the field of exposure to the seabed. The instantaneous position of the transducer is determined in accordance to the formula [18]:

$$B' = R_r^{-1} R_p^{-1} R_y^{-1} B \quad (2)$$

where:  $R_r$  - rotation matrix around the x axis (3);  $R_p$  - rotation matrix around the y axis (4);  $R_y$  - rotation matrix around the z axis (5), B - initial position of the transducer (Fig. 10).

$$R_r = \begin{vmatrix} 1 & 0 & 0 \\ 0 & \cos\theta_r & \sin\theta_r \\ 0 & -\sin\theta_r & \cos\theta_r \end{vmatrix} \quad (3)$$

$$R_p = \begin{vmatrix} \cos\theta_p & 0 & -\sin\theta_p \\ 0 & 1 & 0 \\ \sin\theta_p & 0 & \cos\theta_p \end{vmatrix} \quad (4)$$

$$R_y = \begin{vmatrix} \cos\theta_y & \sin\theta_y & 0 \\ -\sin\theta_y & \cos\theta_y & 0 \\ 0 & 0 & 1 \end{vmatrix} \quad (5)$$

The relationships described in the formulas (3), (4), (5) have been used to assess the change in radiation surface of the acoustic wave and the change in the range of hydroacoustic devices.

## EFFECT OF REFRACTION

Effect of refraction is shown below basing on the results of investigation in June 2017. During the research, images of the bottom's fragments of Gdańsk Bay and information

on the conditions of propagation of acoustic waves during measurements were obtained. The registration of bottom images was carried out in a continuous mode. Conditions for the propagation of the acoustic wave in June 2017 in the vicinity of the Hel Peninsula are presented in the (Fig. 11).

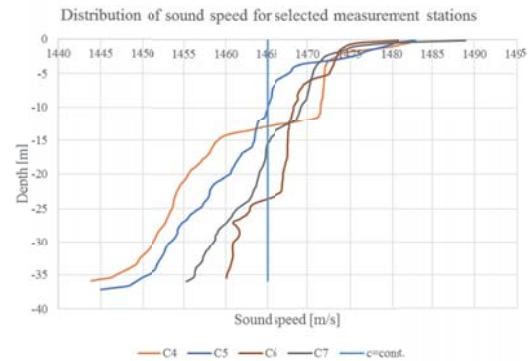

Fig. 11. Sound speed distribution at different stations in the Gdansk Bay in vicinity of the Hel Peninsula in June 2017



Fig. 12. Measuring stations on the Puck Bay

The sound speed at the surface layer varies from 1480 to almost 1490 m/s. For station C4 (Fig. 12), at a depth of about 12 meters, there is a thermocline characterized by a sharp drop in the water temperature by 4 degrees Celsius visible in the distribution of the sound speed. The sound speed at the bottom reaches the value from 1445 to 1460 m/s.

Anomalies in the distribution of the sound speed cause negative refraction. The curves in the (Fig.13) show the range of the side sonar beam under natural conditions and the one determined when assuming a constant sound speed.

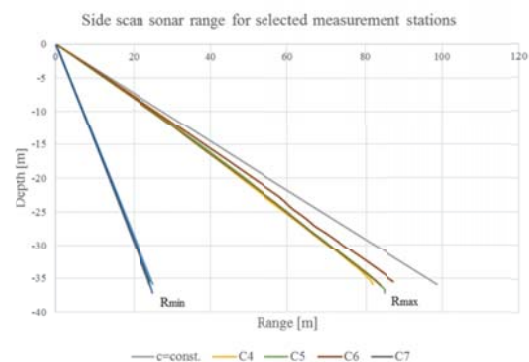

Fig. 13. Side scan sonar range for the speed distribution of given in the (Fig. 10)



The largest changes in range are observed at the bottom. The distance difference for the inner radius does not exceed 70 cm.

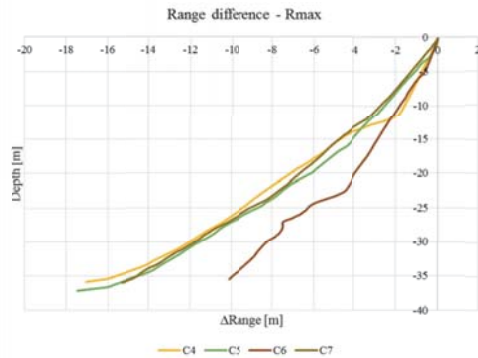

Fig. 14. Range difference for external radius of side scan sonar ( $\alpha_{max} = 70^\circ$ )

The phenomenon of refraction, even at a small depth, significantly changes the range of the side scan sonar compared to the case where the distribution of sound velocity is homogeneous, but also for different distributions measured on the same day at points slightly distant from each other (Fig. 14). The measurement stations were located close to each other, but the difference in range reaches almost 18 meters compared to the case with uniform distribution, and about 8 meters for different measuring stations. Changing the range affects the footprint area.

Tab. 1. Footprint for measuring stations

	C4	C5	C6	C7
Footprint [m <sup>2</sup> ]	187,46	194,69	206,06	193,47
$\Delta$ Footprint [m <sup>2</sup> ]	52,59	45,36	33,99	46,59

Negative refraction caused a reduction of the footprint area by more than 52 m<sup>2</sup> in relation to the footprint at the assumed constant value of the sound speed (Tab.1).

## INFLUENCE OF WAVING

The transverse and longitudinal swaying of a ship's hull and at the same a hydroacoustic transducer attached to it rigidly causes the change of the angle of incidence of the acoustic beam to the bottom and thus the change of the surface of the footprint.

Movements of the measuring ship change the surface of the footprint. Roll increases the beam area on one side of the transmitter, reducing it on the other side (Fig.15). As the roll angle increases, the footprint difference between the actual surface and the surface in the ideal center increases (Tab. 2).

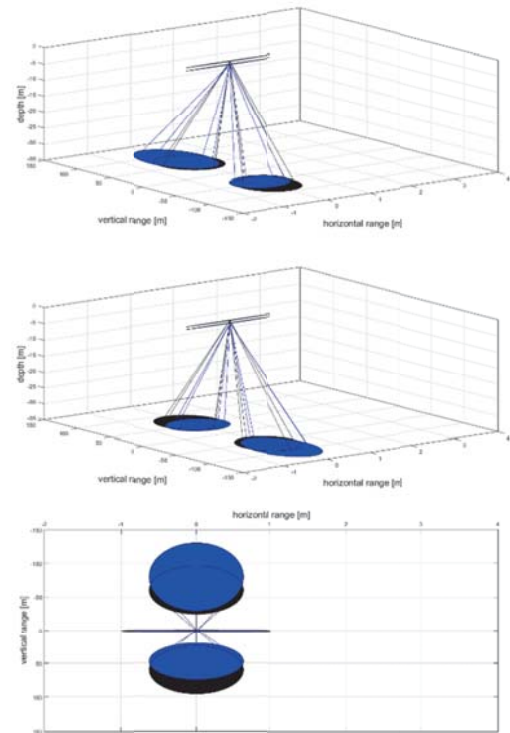

Fig. 15. Difference in footprint of the side scan sonar caused by roll  $\theta_r = 5^\circ, \theta_p = 0^\circ$

a),b) roll to starboard, portboard; c) vertical projection  
black figures - the ideal footprints; blue figures - instantaneous footprints

Tab.2. Footprint for different roll angles

Depth [m]		35
Footprint [m <sup>2</sup> ]	$\theta=0^\circ$	137,53
	$\theta=2^\circ$	139,38
	$\theta=5^\circ$	149,80
	$\theta=10^\circ$	199,41

Depth [m]		35
$\Delta$ Footprint [m <sup>2</sup> ]	$\theta=2^\circ$	1,85
	$\theta=5^\circ$	12,27
	$\theta=10^\circ$	61,88

Pitch does not change the surface of the footprint. Changing the angle of pitch causes the footprint to move along the axis associated with the movement of the measuring vessel (Fig. 16). The larger the pitch angle, the larger the displacement.

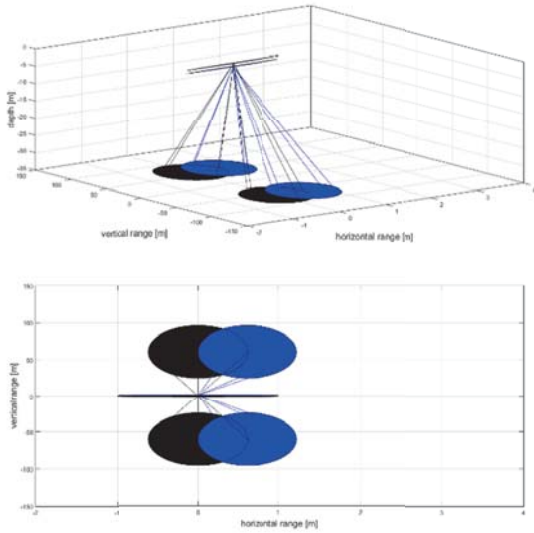

Fig. 16. Changes in the footprint of the side scan sonar caused by pitch  $\theta_r = 0^\circ, \theta_p = 1^\circ$

In real conditions we are dealing simultaneously with roll and pitch, which in effect causes a change of area and shift of the footprint (Fig. 17).

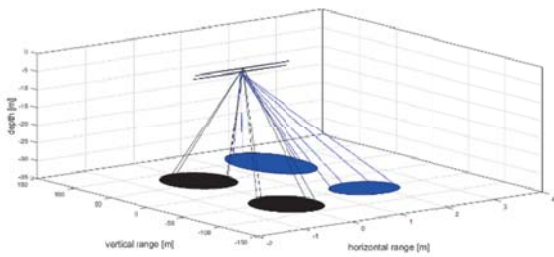

Fig. 17. Footprint of the side scan sonar  $\theta_r = 5^\circ, \theta_p = 3^\circ$

The height of the wave also affects the size of the footprint. the higher the wave height, the larger the footprint changes.

When the ship is at the top of the wave, the footprint is the largest (the distance between the transducer and the bottom increases), if in the valley of the wave the footprint is the smallest (the depth is reduced by a value equal to the wavelength). (Tab. 3) presents examples of footprint changes for different roll angles, with a main depth of 35 meters for a wavelength of 1 m

Tab. 3 Footprint for different roll angles and heave

Depth [m]		35
		$\lambda = 1 \text{ m}$
Footprint [m <sup>2</sup> ]	$\theta = 0^\circ$	129,77
	$\theta = 2^\circ$	133,77
	$\theta = 5^\circ$	141,37
	$\theta = 10^\circ$	188,18

Depth [m]		35
		$\lambda = 1 \text{ m}$
$\Delta$ Footprint [m <sup>2</sup> ]	$\theta = 0^\circ$	7,76
	$\theta = 2^\circ$	5,61
	$\theta = 5^\circ$	8,43
	$\theta = 10^\circ$	11,23

The lateral inclinations of the measuring vessel cause erroneous assessment of the dimension of the object located on the seabed (Fig. 18).

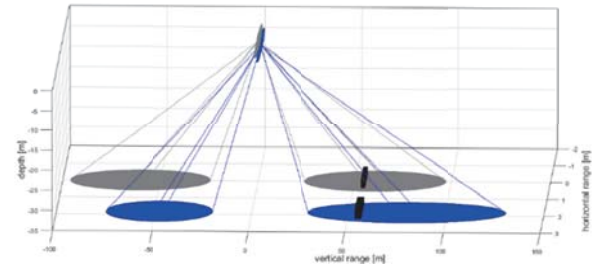

Fig. 18. Change the shape of the object

For example, there is a rectangular element with dimensions of 2m x 0.5m x 2m on the bottom. When roll equal 5° to the right side, its horizontal dimension will be 62% larger – (Fig. 18).

(Fig. 19) and (Fig. 20) show the effect of movement of the ship on the wave on the depiction of the bottom of the Gulf of Gdansk. A small roll distorts sonar images (Fig. 18).

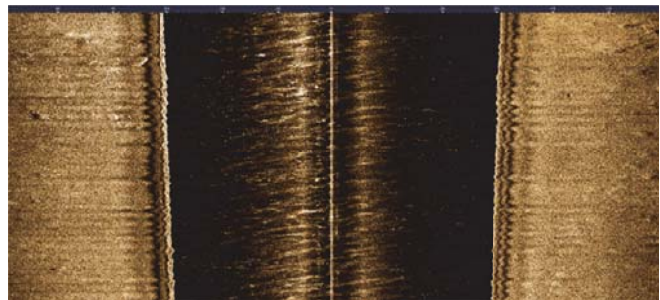

Fig. 19. Bottom image while rolling the ship

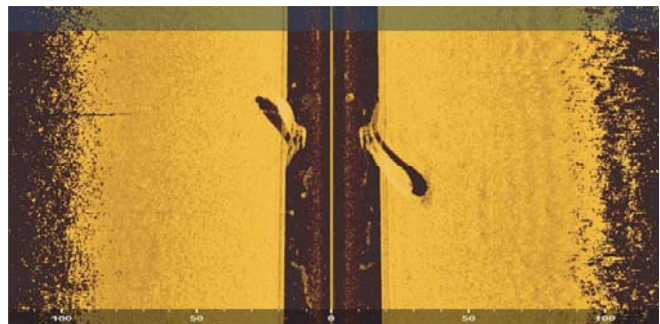

Fig. 20. Image of the bottom from the Puck Bay

## CONCLUSIONS

Natural conditions have a large impact on underwater images obtained using hydroacoustic devices. The spatial distribution of the sound speed field in the Baltic Sea is a consequence of seasonal changes in hydrological conditions into the basin. The water temperature is the factor having the greatest impact on changes in the sound speed. The non-uniform and changing in the annual cycle the distribution of the sound speed causes the refraction of the acoustic beam, which affects the accuracy of the imaging with the use of hydroacoustic devices. The waving is the second factor that influences underwater data imaging. It is a difficult issue, because the specificity of the ship's motion, and hence the measuring device, is not exactly known. It changes the range of the device and the way of displaying objects. The use of a motion sensor improves the situation to some extent. The presented results of our investigation in the Gdansk Bay show how natural conditions influence the range and the area of observation even at small depth of water.

## BIBLIOGRAPHY

1. Belderson R.B., Kenyon N.H., Stride A.H., Stubbs A.R.: *Sonographs of the Sea Floor a Picture Atlas*. Elsevier, Amsterdam, London, New York, 1972
2. Blondel P.: *The Handbook of Side-scan Sonar*. Springer Verlag, 2009
3. Dolecki A., Grelowska G., Oceanographic database – a component of naval operations oceanographic support, *Polish Journal of Environmental Studies*, Vol. 19, 4A, 9-14, 2010
4. Dudziak J., *Teoria okrętu*, Wydaw. Morskie, Gdańsk, 1988
5. Fofonoff N.P. and Millard Jr. R.C., *Algorithms for computation of fundamental properties of seawater (1983)*, UNESCO technical papers in marine science. No. 44, Division of Marine Sciences. UNESCO, Place de Fontenoy, 75700 Paris
6. Grelowska G., Study of seasonal acoustic properties of sea water in selected waters of the southern Baltic, *Polish Maritime Research*, V. 23, 1, 25-30, 2016
7. Grelowska G., Kozaczka E., The study of acoustic climate of the Southern Baltic, *Proc. Mtgs. Acoust.* 28, 005001, 2016; doi: 10.1121/2.0000342
8. Grelowska G., Kozaczka E., Underwater acoustic imaging of the sea, *Archives of Acoustics*, Vol. 39, 4, 439-452, 2014
9. Grelowska G., Kozaczka E., Kozaczka S., Szymczak W., Gdansk Bay seabed sounding and classification of its results, *Polish Maritime Research No 3 (79) Vol 20, s. 45-50, 2013*
10. Grelowska G., Witos D., Acoustic climate of the Gulf of Gdansk in years 2000-2010, *Hydroacoustics* vol. 19, 129-138, 2016
11. Jenkins F.A., White H.E., *Fundamental of Optics*. McGraw-Hill Book Company, 1957
12. Jones E.J.W., *Marine Geophysics*. Wiley, 1999
13. Kozaczka E., Grelowska G., Szymczak W., Kozaczka S., The examination of the upper layer of the seabed by means of the acoustic methods, *Acta Physica Polonica A*, Vol. 119, 6A, 1091-1094, 2011
14. Kozaczka E., Grelowska G., Kozaczka S., Images of the seabed of the Gulf of Gdansk obtain by means of the parametric sonar, *Acta Physica Polonica A*, Vol. 118, No 1, 91-94, 2010
15. Kozaczka E., Grelowska G., Kozaczka S., Szymczak W., Detection of objects buried in the sea bottom with the use of parametric echosounder, *Archives on Acoustics*, 38, 1, 99-104, 2013.
16. Lurton X., *An Introduction to Underwater Acoustics - Principles and Applications*, 2nd Edition, Springer Verlag, Berlin, 2003
17. Savini A.: *Side-Scan Sonar as a Tool for Seafloor Imagery: Examples from the Mediterranean Continental Margin*, Sonar Systems, InTech, Available from: <http://www.intechopen.com/books/sonar-systems/side-scan-sonar-as-a-tool-for-seafloor-imageryexamples-from-the-mediterranean-continental-margin>, 2011
18. Tęgowski J., *Akustyczna klasyfikacja osadów dennych*, *Rozprawy i Monografie*, 19/2006, PAN Instytut Oceanologii, Sopot 2006
19. The BACC Author Team, *Second assessment of climate change for the Baltic Sea basin*, Springer, 2015

## CONTACT WITH THE AUTHORS

Dominika Witos-Okraśńska  
*e-mail: dominika.witos@pg.gda.pl*

Gdańsk University of Technology  
11/12 Narutowicza St.  
80 - 233 Gdańsk  
**POLAND**