

*TOMASZ SEREDYN \**, *ROBERT ROWIŃSKI \*\**

## EXPERIMENTAL INVESTIGATIONS OF A DRIFTING CLOUD OF DROPLETS DISPERSED FROM AIRCRAFT

With widespread use of pesticides in modern agriculture, the impacts of spray drift have become a topic of considerable interest. The drifting of sprays is a highly complex process influenced by many factors. The paper presents results of experimental research on a drifting cloud of droplets dispersing from aircraft. Experiments were conducted to quantify spray drift from aerial applications of pesticide. Parallel to the blowing wind, the measurement line 800 m long was disposed. The relationships between the relative dose and the distance of drift as well as spray density and its structure on the measuring length have been established.

### 1. Introduction

Spreading of liquid chemicals from the air in the form of droplets, aerosols or water bombs, plays an important role in military and civilian applications. This applies, for example, to herbicide defoliation of areas being the enemy shelter terrain or directly the battlefield: fogging of warfare areas or spreading of liquid chemicals for various purposes. In civil applications, issues such as crop protection treatments or forestry plants protection, control and fire protection of forests including the implementation of liquid bombs dropping on the burning zones should be mentioned. They seem to be, in many cases, the only effective means of protection. The main advantage of the use of aviation technology is its speed, which allows one to reach the treatment area in the shortest possible time, ensuring the reduction of losses and high efficiency operation.

---

\* *National Security and Logistics Faculty, Polish Air Force Academy, Dywizjonu 303 12, 08-521 Dęblin, Poland; E-mail: t.seredyn@wsosp.deblin.pl*

\*\* *Aviation and Aeronautics Faculty, Polish Air Force Academy, Dywizjonu 303 12, 08-521 Dęblin, Poland; E-mail: robert.rowinski@op.pl*

The main limitations of the use of aviation in the prevailing meteorological conditions are posing a threat to the pilot as well as affecting the quality of the treatment. This is mainly, though not exclusively, due to the possibility of drifting of means beyond the treatment zone, what causes environmental pollution (other crops, water reservoirs, urban or recreational areas). On account of nature and complexity of these issues, the theoretical analyses were conducted, starting from the work of W. H. Reed in 1954 (NACA Report) and subsequent several works [1, 2, 5, 8, 9, 13, 15]. In these works, there were assumed the movement of cloud of droplets drifting with the cross-wind and turbulence in two models, contractually called the 'free' model and the 'fixed' model. The first model does not take into account the disturbance of velocity fields after flying aircraft on the movement and distribution of liquid droplets. The second model takes into account this factor as well as other parameters affecting the trajectory of a particle, for example the impact of the ground as well as the type of canopy. Due to the simplifications of mathematical models, also widespread experimental studies were carried out [3, 4, 7, 10, 14, 16] over 50 years. According to Elliot and Wilson [6], these studies were often too superficial and strongly limited. Moreover, different measurement techniques applied greatly hindered the comparison of the research results.

In the 70s and 80s, Poland was one of the largest manufacturers of agricultural aircraft and helicopters. Moreover, Poland led large-scale treatments for agriculture and forestry in the country and abroad. In Poland, they exceeded 3 million hectares in the years 1980–1989, while the export of services amounted to a total of 30 million hectares in the period from 1970 to 2000. In this situation, a fundamental issue has become a matter of the technical evaluation of agricultural aircraft and the treatments performed by means of the equipment. The applicable research methodology was developed [12] and it was the basis for the certification of this equipment. After international consultations and some supplements this methodology was recognized "for use" in Czechoslovakia, Bulgaria, Poland, East Germany and the Soviet Union. At that time, there were also many theoretical and experimental studies on this subject. Treatments for agriculture in Poland have been completed due to the liquidation of state-owned farms, which were the main recipient of these works. The treatments are continued only for forestry pest control and fire protection of forests. As a result of the EU Directive 2009/128/EC, which banned the use of aviation in plant protection treatments, useful and effective aviation operations have been completed. This paper outlines the research methodology and results of experimental tests conducted by means of helicopters never published so far. For these reasons, it seems appropriate from the scientific and application point of view, to start researches on physics of drifting spray dispersed by means of aviation technique.

The aim of this study was to conduct experimental research of liquid spreading from the aircraft – the Mi-2 helicopter, enabling the identification of the mass of liquid and sizes of settled droplets and, on the other hand, this part of the spray, which was lifted with the cross wind.

## 2. Material and methods

### 2.1. Object of research

As it was already mentioned, the object of research is the helicopter Mi-2, equipped with apparatus for ULV spraying in the form of two rotating sprayers (atomizers) AR-86.00.00 produced by the WSK PZL Świdnik, used in chemicalization treatment. For the study it has been assumed an altitude of the aircraft equal to  $h = 5$  m and a speed corresponding to the most commonly used in treatments by means of helicopters  $v_r = 22$  m/s. All apparatuses, before the agrotechnical experiments, were subjected to technical tests in accordance with the standard methodology [12], including: control of the correctness of installation in accordance with the technical documentation, tests of the flow characteristics as well as the flow rate as a function of adopted settings and the atomizers rotation. The helicopter was equipped with measuring equipment that allows registration of: flight speed, pump rotations, atomizers rotation, and the pressure behind the pump.

### 2.2. Working fluids

To avoid any risk to the environment and to staff, involved in experiment, the following model fluids were used in the studies.

1. 2% water solution of nigrosine assigned as N.
2. 30% water solution of urea with the addition of 2% of nigrosine assigned as M.

The physical properties of the model liquids are presented in Tab. 1. The first of the applied model fluids corresponds to the liquid chemicals,

Table 1.

The physical properties of the model fluids

Solution	Density	Surface tension	Viscosity
	[kg/m <sup>3</sup> ] $10^3$	[N/m] $10^3$	[Pa·s] $10^3$
N	1.001	64.14	1.10
M	1.086	36.85	2.81

based on a water carrier. The use of urea in the second liquid increased its density and viscosity as well as reduced the surface tension and evaporation. Moreover, the use of urea resulted in increased sedimentation velocity.

### 2.3. Location and measuring line

Field experiments were carried out in the years 1987–1992 on the Academy of Agriculture and Technology in Olsztyn research training ground constituted at the former airfield in Gryźliny near Olsztyn at the area 150 hectares covered with grass.

In this area, parallel to the direction of the wind, a 800 m long measurement line was delineated. Inside the line, the following samplers were laid out:

1. To measure the mass distribution – cellophane samplers ( $0.01 \text{ m}^2$  each) were distributed horizontally at grass level (0.20 m), every two meters over a distance of 140 m from the helicopter.
2. To measure the liquid dispersion – dispersion in this case is understood as the number of droplets and the structure of their spectrum obtained from the surface of samplers. Samplers were microfilm negative tapes, marked and plastified with  $6 \mu\text{m}$  of thick mineral oil. This tape was then cut and framed for slides (more in Rowiński et al., 1988).

The tests were conducted using indirect methods, by measuring fixed, coloured traces of model liquid on the surface of the samplers at  $7.03 \text{ cm}^2$ . This unique method allowed us to determine not only the size and density of the spray but also, which is very important, changes in the diameter of the droplets for the given drift distance, which is a kind of measure of the evaporation of the droplets. The above mentioned samplers depicted on a schematic drawing of the experimental site in Fig. 1 were placed:

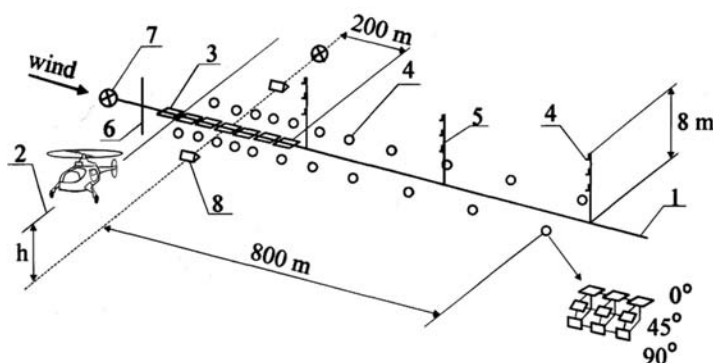

Fig. 1. The schematic drawing of the research experiment site and the measurement line:  
 1 – measure line, 2 – flight path, 3 – mass samplers, 4 – droplet samplers, 5 – masts,  
 6 – measurements of meteorological parameters, 7 – cameras, 8 – markers

- on stands, distributed horizontally ( $0^\circ$ ), at an angle of ( $45^\circ$ ) and vertically ( $90^\circ$ ). The stands with samplers were placed in two rows. One row had 9 samplers (three in each exposure), which were replaced after every test flight. The other row had 3 samplers (one in each exposure), which were replaced after each series of three test flights of an agricultural aircraft.
- on 8 meter tall masts, distributed 100 m, 300 m and 500 m from the beginning of the measure line. The samplers on the masts were distributed every one meter, one vertically and one horizontally along the whole mast length.

#### 2.4. Technical data and conditions of the treatment

Tab. 2 presents the adopted sets of feeders of rotary atomizers AR-86.00.00 in their minimum ( $d_1$ ) and maximum ( $d_5$ ) settings, applied pressure, the average atomisers rotational speed, flow rates and doses as well as the flight parameters of the aircraft.

Table 2.

Technical parameters of equipment and flight parameters

Liquid	Feeder setting	Liquid pressure	Flow rate	Dose for $B=30$ m	Flight velocity	Flight altitude
	$d$	$p$ [MPa]	$W$ [dm <sup>3</sup> /s]	$D$ [dm <sup>3</sup> /ha]	$v$ [m/s]	$h$ [m]
N	1	0.52	0.511	8.07	21.1	5
N	5	0.37	1.378	20.64	22.2	5
M	1	0.53	0.528	7.98	22.2	5
M	5	0.39	1.378	20.23	22.8	5

In Tab. 3 the meteorological conditions during the experiment are given. As for this kind of experiment, priority has to be given to the high stability of weather conditions, the repeatability of the meteorological conditions during the research is here important. Only in the average wind velocity the conditions were different.

Table 3.

Meteorological conditions

Liquid	Feeder setting	Temperature	Humidity	Average wind velocity	Wind direction
	$d$	$T$ [K]	$\psi$ [%]	$v_w$ [m/s]	$\alpha$ [ $^\circ$ ]
N	1	290.1	65	4.8	0
N	5	290.0	65	5.0	0
M	1	290.2	65	3.4	0
M	5	290.2	65	5.1	0

## 2.5. Directional flight line

Thirty meters from the zero point of the measure line a direction line perpendicular to it was determined for the agricultural aircraft flight. This was marked with markers which informed the pilot where to switch the spraying on and off. This distance was equivalent to 5 s of agricultural aircraft flight before and 5 s of the flight after the measuring line. Each flight was conducted at a speed and altitude accepted in research programmes and was rectilinear without rolling or yawing. The correctness and height of each flight were controlled by the pilot. Moreover, they were registered by two coupled cameras, perpendicular to each other. Close to the measuring line, at a height of two meters, meteorological conditions during the test were registered. The following data were measured and registered: temperature, wind velocity (gust velocity included) and its direction as well as relative humidity. The field research was carried out only under specified weather conditions, i.e. early in the morning till 8.00-8.30 am and in the afternoon until sunset. At this time the wind gusts are negligibly small. When the wind gusts exceed the given limit or change the wind direction results were not considered, and the measuring line was moved. Fig. 1 shows the scheme of the measure line. After the flight and subsidence of the spray cloud (8–10 min.) the samplers were collected and replaced by new ones. Each trial was repeated three times.

## 2.6. Analysis of research material

Mass distribution was analyzed using the colorimetric method on a spectral colorimeter with a length of  $\lambda = 580$  nm. After recalculation, the distribution was presented in the form of the dose distribution in the distance function  $D_p = f(y)$  for each performed flight. That was the basis for the analysis of the mass distribution as a function of distance from the axis of the aircraft flight. The starting dose used during the treatments is a technical dose. It is determined from the equipment settings, the operating speed of the aircraft and the working swath. The relative measure of the drifting fluid is the quantity:

$$\hat{D} = \frac{D_p}{D_T} \quad (1)$$

for the measuring point, and

$$\hat{D} = f(y) \quad (2)$$

as the variability of the relative value of the drift  $\hat{D}$  as a function of the distance perpendicular to the axis of the flight  $y$ . The number of drops, the

surface density and the spectrum of droplets were determined on a computer image analyzer, based on fixed coloured droplet traces. The traces were grouped into ranges, according to trace sizes. The collection of droplet traces, arranged according to droplet diameters, was converted into a collection of droplets, based on equations presented in Tab. 4. For the selected class ranges of droplets diameters traces, to convert the spectrum traces of drops on the spectrum of settled droplets, the computer software was used. The results are recorded in the form of the split, ordered series from each measuring point.

Table 4.

Scaling equations

Solution	Functional dependence of droplet diameter $d$ from the trace $d_s$	$d_s$
N	$d = 0.0087 + 0.54155d_s - 0.13643d_s^2 + 0.01459d_s^3$	$> 0 - 1.7$
M	$d = 100.707 + 0.5633d_s$	$> 0 - 600$

These results are presented as size, surface density (spray density), average diameters (arithmetic and volumetric) and medians (quantitative and volumetric). This made it possible to present the cumulative quantitative and volumetric distributions, representing the information about the structure of the droplet spectrum. The results were recorded for each measurement point, the sum of amount of drops from the different classes, therein separately for masts.

### 3. Results and discussion

Due to the obtained extensive research material, only the distribution of the mass, the spray density and the structure of the sprayed droplet spectrum are presented below. Some issues relative to drifting droplets settled on the masts, for example, the influence of the position of the probes on the density of the spray are not mentioned.

#### 3.1. Mass distribution

The cross wind caused the considerable drift of spraying at a distance greater than 120 m. The average drift distances from the three repetitions for both used liquids amounted to:  $N(d_1)$ –71 m,  $M(d_1)$ –101 m,  $N(d_5)$ –76 m and  $M(d_5)$ –117 m. An example of the nature of the liquid mass distribution from the averaged three air raids on the line measurement is shown in Fig. 2. The comparison with the theoretical distribution shows, that the 'free' models do not properly reflect the results of field experiments. The percentage distribution of the field dose  $D_P$  in 30-meters spraying strips is shown in Fig. 3.

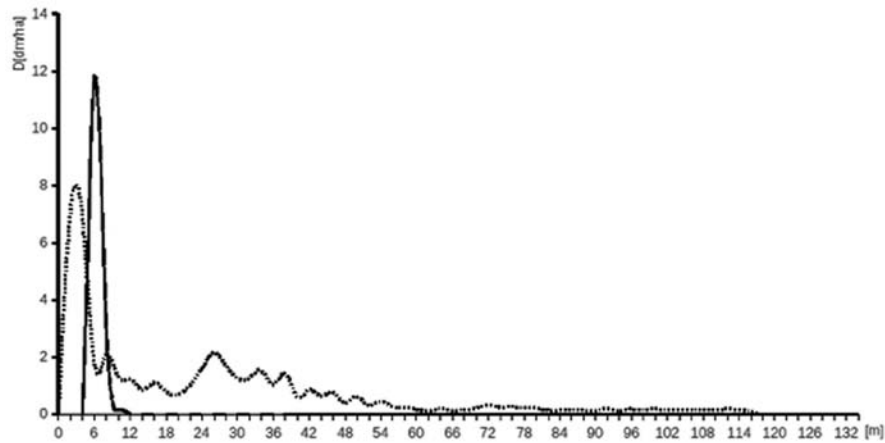

Fig. 2. Averaged distribution of the sprayed mass of liquid M: solid line – theoretical distribution [13], dotted line – setting  $d_5$

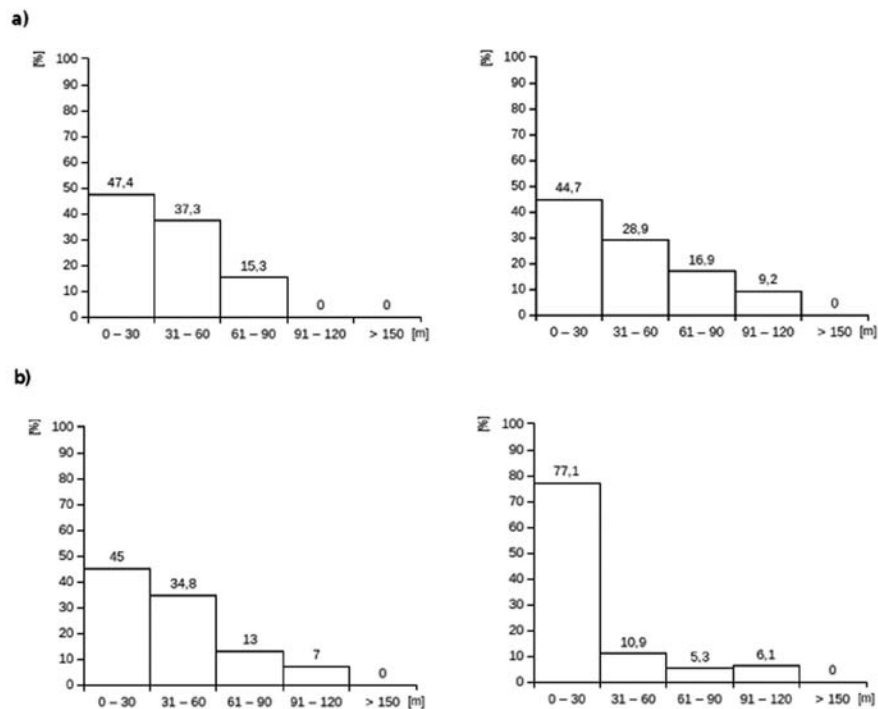

Fig. 3. Percentage distribution of the field dose in the 30 meter strip: a) setting  $d_1$ , left – liquid N, right – liquid M, b) setting  $d_5$ , left – liquid N, right – liquid M

The experiments were carried out with the airplane An-2, where rotary atomizers were built (the model AU-3000 developed by Atomizer GmbH, Germany). In these studies, due to the large amount of data, one could afford their statistical interpretation and derive mathematical relations specifying the



relative dose, expressed as the ratio of the field dose to the technical dose, as a function of dispersed liquid distance  $y$  in the form:

$$\hat{D} = \frac{D_P}{D_T} = 0.3032 - 0.0613 \ln(y/y_0) \quad (3)$$

with the correlation coefficient  $r^2 = 0.9932$  for  $15 \text{ m} < y < 140 \text{ m}$ .

### 3.2. Droplets distribution – subsidence

In the studies of liquid spraying, one used laboratory tests to determine any spectrum of generated droplets for the design of the nozzle, its diameter and the pressure applied (usually referred to water). These values are the basis for the application of plant protection products in the ground sprayers, where the machine operating speed is low. For agricultural aircraft, the structure of the spectrum is determined in flight, during the field tests.

There were drops, sedentary on the horizontal samplers, spaced within 800 meters measuring line under examination. The results indicate a divergence in the number of drops on samplers from  $n = 1423$  for the nigrosine solution and the feeder setting  $d_1$  to  $n = 6162$  for the urea and nigrosine solution with the feeder setting  $d_5$ . These differences may be explained by a higher dose and less evaporation of urea droplets.

From the measurements obtained from the measuring line it follows that for the cross wind  $v_w = 3 \text{ m/s} - 5 \text{ m/s}$ , regardless of the fluid used and the dose, the spray settles down to about 120 m. On the other hand the average number density of the spray varies from  $g = 4.8 \text{ drops/cm}^2$  for  $N(d_1)$  to  $g = 29.2 \text{ drops/cm}^2$  for  $M(d_5)$  in the working swath of  $B = 30 \text{ m}$ .

The characteristics of the liquid drops for the average volume diameter showed similar values for both liquids at the lower flow rates  $W = 0.5 \text{ m}^3/\text{s}$ . For the flow rates  $W = 1.4 \text{ m}^3/\text{s}$ , this difference was  $25 \mu\text{m}$ . This concerned the median volume as well, except that the difference for higher flow rates was about  $50 \mu\text{m}$ . An important characteristic constituted as well the cumulative distributions of droplets spectra (quantitative and volumetric) that were presented for model liquids in Fig. 4, 5, 6 and Fig. 7. The whole characteristics of the sedentary droplets along the measuring line are illustrated in Tab. 5.

### 3.3. Droplets distribution on the masts

The measure of cloud droplets lifted with the cross wind is their subsidence on samplers, spaced on 8-meter high masts at a distance of  $y = 100 \text{ m}$ ,  $300 \text{ m}$ ,  $500 \text{ m}$ , from the beginning of measurement line. In Fig. 8 and 9 a spray density distribution varying with a height and a distance of the mast

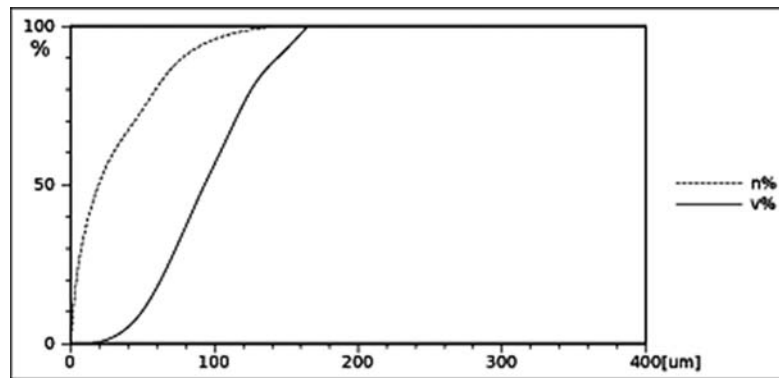

Fig. 4. Cumulative distribution of droplet spectra for the nigrosine solution with setting  $d_1$  (v% – mass, n% – number of droplets)

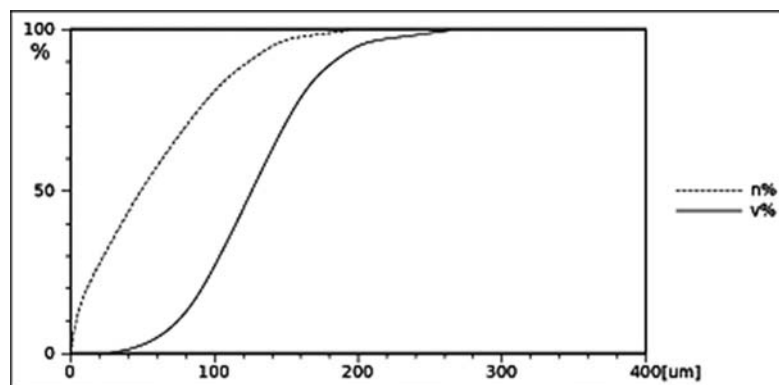

Fig. 5. Cumulative distribution of droplet spectra for the nigrosine solution with setting  $d_5$  (v% – mass, n% – number of droplets)

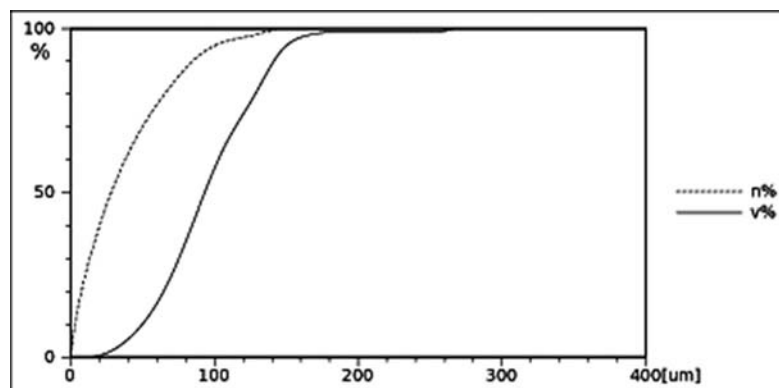

Fig. 6. Cumulative distribution of droplet spectra for the urea solution with the addition of nigrosine with setting  $d_1$  (v% – mass, n% – number of droplets)

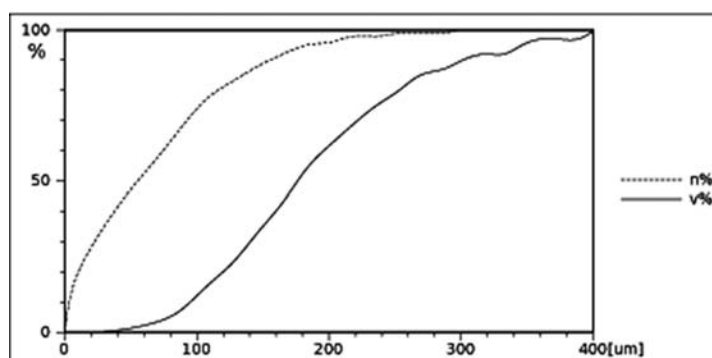

Fig. 7. Cumulative distribution of droplet spectra for the urea solution with the addition of nigrosine with setting  $d_5$  (v% – mass, n% – number of droplets)

Table 5.

Characteristics of liquid droplets in the spray strip

Liquid	Feeder setting	$n$ (number)	$g$ (drs/cm <sup>2</sup> ) for $B=30$ m	$d_v$ ( $\mu$ m)	$VMD$ ( $\mu$ m)	$B_0$ (m) max. drift
N	1	1423	4.5	62.9	93.6	83.7
N	5	4376	20.7	92.9	125.6	120.0
M	1	4720	14.9	67.1	93.8	120.0
M	5	6162	29.2	117.6	176.5	128.0

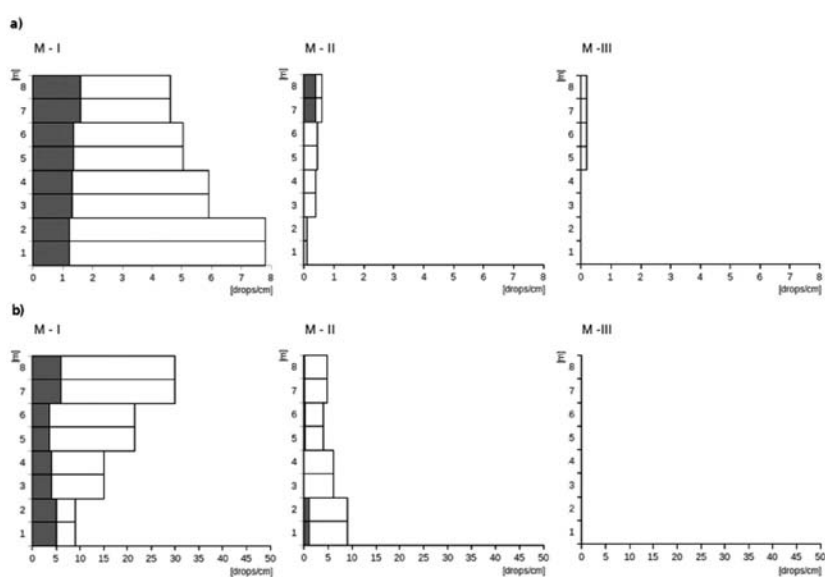

Fig. 8. Density distribution of the spray on masts for the nigrosine solution (gray color – horizontal samplers, white color – vertical samplers): a) setting  $d_1$ , b) setting  $d_5$

placing is shown. It is worth noting the considerably higher density values for the water solution of nigrosine with the urea addition.

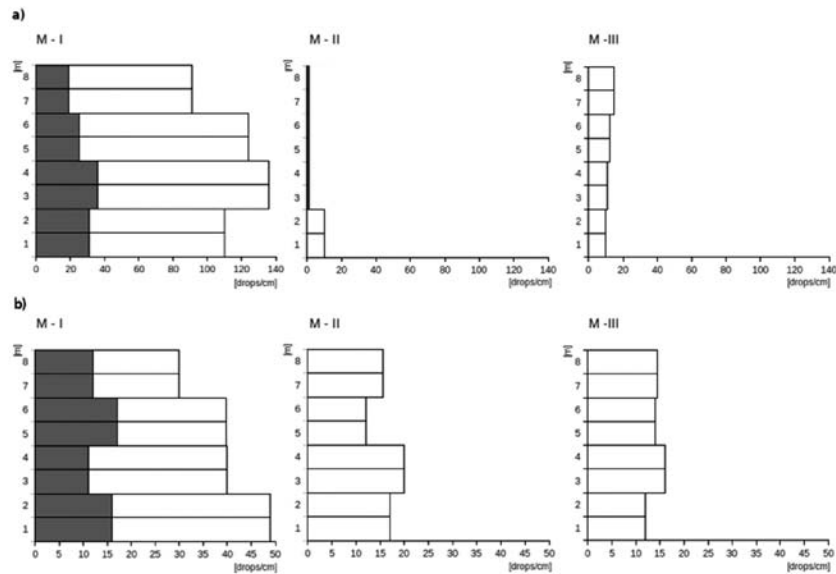

Fig. 9. Density distribution of the spray on masts for the urea solution with the addition of nigrosine (gray color – horizontal samplers, white color – vertical samplers): a) setting  $d_1$ , b) setting  $d_5$

Table 6.

Characteristics of liquid droplets settled on the masts

Liquid	Feeder setting	100 m	300 m	500 m
		$g$ (drs/cm <sup>2</sup> )	$g$ (drs/cm <sup>2</sup> )	$g$ (drs/cm <sup>2</sup> )
N	1	5.7	0.4	0
N	5	18.8	6.0	0.2
M	1	113.3	36.5	19.5
M	5	39.6	28.7	15.4
		$d_v$ ( $\mu\text{m}$ )	$d_v$ ( $\mu\text{m}$ )	$d_v$ ( $\mu\text{m}$ )
N	1	89.7	67.7	0
N	5	80.8	82.5	89.0
M	1	65.4	61.1	53.5
M	5	77.3	98.7	66.9

From the data contained in Tab. 6 it can be determined a significant density of the spray settled on the masts – also in the 300 m and 500 m distances. In the case of real fluids, it can constitute a very important toxic

factor, which could pose a threat to neighboring crops, water bodies, urban areas and parks. Therefore, the protective zones shall be determined, securing the area against any potential negative effects of the spray drift.

#### 4. Conclusions

1. The research allowed us to determine the mathematical relationships for the relative measure of the drifting fluid.
2. This allows one to determine protection zones consisting of insulating lanes and safety zones for applications of certain plant protection products.
3. It is advisable, from a scientific and application point of view, to carry out further research in this field, both experimental and theoretical to describe the physics of movement and sedimentation of liquid droplets distributed from an airplane.

#### Appendix

List of the major symbols and abbreviations:

$d$	$[\mu\text{m}]$	droplet diameter
$d_s$	$[\mu\text{m}]$	trace droplet diameter
$d_v$	$[\mu\text{m}]$	mean volume diameter
$d_{v_0}$	$[\mu\text{m}]$	initial mean volume diameter
$h$	$[\text{m}]$	aircraft altitude
$g$	$[\text{kg} \cdot \text{cm}^{-2}]$	spray density
$p$	$[\text{MPa}]$	pressure
$n$		total number of droplets
$D_P$	$[\text{dm}^3 \cdot \text{ha}^{-1}]$	field dose
$D_T$	$[\text{dm}^3 \cdot \text{ha}^{-1}]$	technical dose
$T$	$[\text{K}]$	temperature
$v_w$	$[\text{m} \cdot \text{s}^{-1}]$	average wind velocity
$v_r$	$[\text{m} \cdot \text{s}^{-1}]$	operating speed
$W$	$[\text{dm}^3 \cdot \text{s}^{-1}]$	flow rate
$VMD$	$[\mu\text{m}]$	volumetric median
$\alpha$		angle
$\psi$	$[\%]$	relative humidity
$\omega$	$[\text{s}^{-1}]$	angular velocity

$d_1$	number of feeder setting
$N$	2% water solution of nigrosine
$M$	30% water solution of urea and 2% of nigrosine
$ULV$	ultra low volume

Manuscript received by Editorial Board, April 18, 2012;  
final version, April 08, 2014.

#### REFERENCES

- [1] Bache D. H., Johnstone D. R.: Microclimate and Spray Dispersion. Chichester, Ellis Horwood Limited, 1992.
- [2] Bache D. H., Sayer W. J. D.: Transport of Aerial Spray, I. A Model of Aerial Dispersion. Agric. Meteorol., 1975, Vol. 15, No. 2, pp. 257-271.
- [3] Chladek Z.: Zagadnienia znoszenia kropeł cieczy przy maooobjętościowym opryskiwaniu lotniczym. Warszawa, Aero-Agro. Seminarium Europejskiej Komisji Gospodarczej ONZ, 1978, pp. 307-312.
- [4] Courshee R. J.: Drift of Spray Applied from Low Flying Aeroplanes. Cranfield, Raport of First International Agricultural Aviation Conference, 1959, pp. 148-157.
- [5] Csanady G. T.: Turbulent Diffusion in the Environment. Dordrecht, D. Reidel Publishing, 1973.
- [6] Elliot J. G., Wilson B. J.: The Influence of Weather on the Efficiency and Safety Pesticide Appliation. UK, Occasional Publication No. 3, Report of BCPC Res & Dev. Committe, 1983.
- [7] Hartley G. S.: Physics of Droplet Drift by a Wind. Cranfield, Raport of First International Agricultural Aviation Conference, 1959, pp. 142-147.
- [8] Kaul P., Mayer E., Gebauer S.: Direkte Abtrift von Pflanzenschutzmitteln – Flugzeug. Nachrichtenbl. Deut. Pflanzenschutzd., 1995, 47, pp. 36-44.
- [9] Lawson T. J., Uk S.: The Influence of Wind Turbulence, Crop Characteristics and Flying Height on the Dispersal of Aerial Sprays. Atmospheric Environment, 1979, Vol. 13, No. 5, pp. 711-715.
- [10] Parkin C. S., Merritt C. R.: The Measurement and Prediction of Spray Drift. UK, ICAP. Cranfield Institute of Technology, 1989.
- [11] Ranz W. E., Marshall W. R.: Evaporation from Droplets. Chemical Engineering Progress, 1952, Vol. 48, No. 3, pp. 141-146, No. 4, pp. 173-180.
- [12] Rowiński R. S., Wodecka C., Jumrych M.: Metodyki badań aparatury agrolotniczej. Olsztyn, ART-Olsztyn, 1988.
- [13] Rowiński R. S.: Problems of Spray Drift in Plant Protection Using Aviation Techniques. Acta Academiae Agriculturae ac Technicae Olstenensis. Agricultura, 1993, Vol. 56, pp. 171-195.
- [14] Rowiński R. S.: Methods Related to the Safety Application of Herbicides from Agricultural Aircrafts. Norway, International Seminar CIGR. Agric. University of Norway. Ass., 2002, pp. 226-231.
- [15] Trayford R. S., Welch L. W.: Aerial Spraying: A Simulation of Factors Influencing the Distribution and Recovery of Liquid Droplets. Journal of Agricultural Engineering Research, 1977, Vol. 22, No. 2, pp. 183-196.
- [16] Wanner R.: Evaporation of Water Based Pesticide Formulation In Aerial Applications. Turin, 6th International Agricultural Aviation Congress, 1980, pp. 252-271.

**Badania eksperymentalne znoszenia chmury kropeł rozprzestrzenianych ze statku powietrznego****Streszczenie**

Wraz z rozwojem współczesnego rolnictwa i stosowaniem na coraz szerszą skalę pestycydów, problem znoszenia oprysków podczas ich aplikacji i po, stał się ogromnym wyzwaniem. Od strony samego zjawiska fizycznego problem znoszenia oprysków jest bardzo skomplikowany i trudny do badań. Jest to wynikiem wpływu na proces rozpylania wielu czynników zewnętrznych. Praca ta prezentuje wyniki badań polowych dotyczących zachowania się chmury kropeł rozprzestrzenionych ze statku powietrznego. Eksperymenty były prowadzone w celu ilościowego opisu zachowania się oprysku i jego rozkładu na podłożu. Równoległe do kierunku wiatru usytuowana została linia pomiarowa o długości 800 m. W oparciu o nią ustalono zależności wielkości dawki względnej od odległości znoszenia, gęstość oprysku oraz jego strukturę na długości pomiarowej.