

EXPERIMENTAL STUDY OF FOAM FILLED ALUMINUM COLUMNS UNDER AXIAL IMPACT LOADING

Leonardo Gunawan, Annisa Jusuf, Tatacipta Dirgantara, Ichsan Setya Putra

*Institut Teknologi Bandung
Faculty of Mechanical and Aerospace Engineering
Ganesa 10, Bandung 40132, Indonesia
tel.: +62 22 2504243, fax: +62 22 2534199
e-mail: gun@ae.itb.ac.id, annisajusuf@ftmd.itb.ac.id
tdirgantara@ftmd.itb.ac.id, isp@aero.pauir.itb.ac.id*

Abstract

The work presented in this paper is the experimental study of square aluminum columns under dynamic axial impact loading. The objective of the study is to evaluate the effect of foam filling to the crushing behaviour of the columns. Four columns were tested, i.e. a single walled column, a single walled column filled with aluminum foam, a double walled column, and a double walled column filled with foam. The single walled column was 55 mm wide and 1.3 mm thick. The double walled column was prepared by inserting a square column of 38 mm wide and 1.15 mm thick inside the single walled column. The column was made of aluminum extruded alloy AA 6063 T1, and the insert material was the closed cell aluminum foam (ALPORAS) with density of 440 kg/m³. The tests were carried out using a dropped weight impact testing machine that had been built specifically for this purpose. The results showed that filling the aluminum foam to the columns increase their crushing resistance force, where the increase is of the single-walled column is higher than that of the double-walled column. Filling the foam to the columns reduce the high crushing force peak for both columns as well. This experimental results confirm results of other researcher.

Keywords: transport, road transport, safety

1. Introduction

Thin-walled column has been known as a promising and efficient impact energy absorbing devices in space frame concept. For single-walled column, the most effective way to increase its axial crushing resistance is by thickening its wall. This method, however, will increase the mass of the column as well. Another consideration in using the thin-walled structures as an energy absorption device is the high first peak force to initiate the buckling of the structure. Usually, a trigger is introduced to the column to decrease the high first peak force.

Filling a column with foam will improve energy absorption characteristics and stabilize the buckling process of the column [1-7]. During the axial crushing process, the interaction between the filler and the walls which constrains inward and outward fold formations produces some advantageous crushing and energy absorption characteristics of the column. The mean crushing force of the filled column is found to be higher than the sum of the crushing force of the foam and that of the columns alone, while the weight efficiency is maintained and the high first peak force is reduced. To achieve the same level of energy absorption for light weight design, filling the column with low density foam are preferable than thickening the column walls. Thornton [1] is the first who proposed the method to reinforce thin-walled components by filling the empty space in the component with polyurethane foam. Niknejad et al. [2, 3] developed a theoretical formula to predict the crushing force of polyurethane foam-filled square and grooved circular columns under axial loading. The theoretical predictions correlated well with experimental results. Recently, metal foam is developed as a new ultra-lightweight engineering material. It can undergo large strain deformation while maintaining its low constant stress before the densification [4]. Numerical studies of Santosa et al [8] showed the superior weight efficiency of thin-walled member filled with metal foam core.

Another method to increase the crushing force resistance of columns and keep their weight low is to use a double-walled column filled with foam between the outer and inner wall. By using quasi-static experimental investigations, Seitzberger et al. [9] showed that double-walled columns consisting of outer and inner profiles with foam in between are particularly efficient energy absorbing devices, as long as global failure can be avoided. By using non-linear dynamic finite element analysis, Santosa and Wierzbicki [10] showed that the mean crushing force of square double-walled column with foam metal fillers is significantly higher than that of thin-walled column with the same thickness. In the optimization of the crashworthiness of the double-walled, single-walled foam-filled and double-walled foam-filled square column, Zhang et al. [11] demonstrated that the double-walled foam-filled configuration can be an efficient energy absorber and that it has more room to enhance the crashworthiness.

So far there is limited experimental data available on the crushing behaviour of foam filled column, especially the double-walled foam filled column. This paper presents results of experimental study of foam-filled aluminum columns under axial impact load. The crushing behaviour data has been used to validate a finite element model in impact analysis of crash boxes.

2. Test Setup and Specimens

2.1. Test Setup

The tests were conducted by using a dropped weight type impact testing machine at Lightweight Structure Research Group - Institut Teknologi Bandung as shown in Fig.1. The machine has the capability to crush test specimens with a maximum impact speed of 9.8 m/s and impactor mass from 20 kg up to 150 kg [12]. It is able to accommodate impact tests on specimens of various cross sectional geometry with maximum outer geometry of 60 mm and maximum height of 180 mm. In the experiment, the specimen with its longitudinal axis in vertical direction was mounted on top of a loadcell. The impactor which had been positioned on a certain height according to the desired impact velocity, was then released and moved downward to crush the column from above. The loadcell system, which has a maximum capacity of 65 kN and uses two strain gages in a full Wheatstone bridge circuit, measured the instantaneous crushing force-time history of the specimen. The electrical output signal of the Wheatstone bridge was filtered and amplified using a Kyowa CDV-700A signal conditioner, digitized by using a data acquisition card NI USB-6211 with a sampling rate of 250 kHz, and finally recorded by a PC for further analysis.

The speed of the impactor before hitting the specimen was determined by using an Autronics® counter which measures the elapsed time of the impactor assembly passing through two infrared diode sensors. The speed of the impactor was determined by dividing the distance between the two sensors with the elapsed time. The displacement time history of the column was obtained from camera Nikon 1 J1 which has the capability to take pictures with maximum rate of 1200 fps. From the force and displacement time history, the force vs displacement curve was prepared.

2.2. Specimens

Four column configurations were studied, i.e. a single-walled (SW), a double-walled (DW), a single walled foam-filled (SWFF), and a double-walled foam-filled (DWFF) column. The geometry of the columns is shown in Fig. 2. The columns were made from extruded aluminum alloy square columns (AA 6063 T1), where the wall thickness of the inner columns was uniform but that of the outer columns was not. The filling foams were the closed-cell aluminum foam blocks (ALPORAS) manufactured by Shinko Wire which were inserted without adhesive bonding with the column walls. The foam is classified as a high density foam with density of about 440 kg/m³ or relative density of 0.16, and has average cell size of about 2.43 mm.

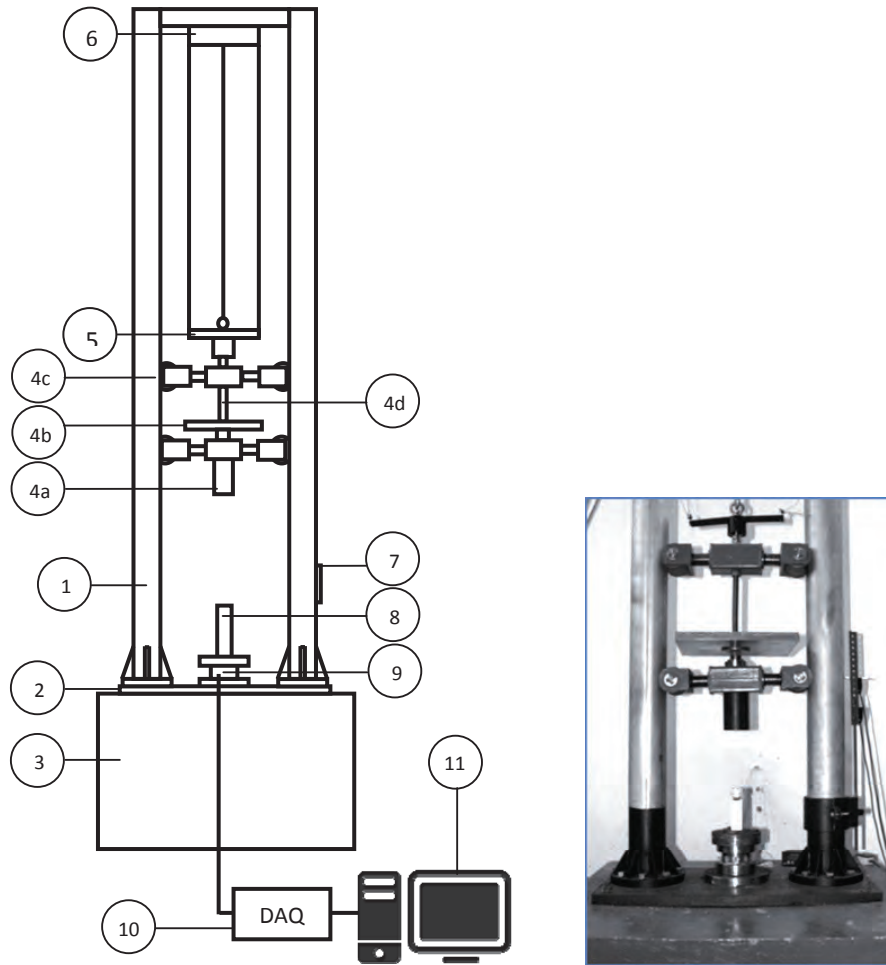

No.	Name	Qty.
1	Guide columns	2
2	Steel plate	1
3	Concrete base	1
4	Impactor assembly	
	a. Impactor head	1
	b. Weightening mass	
	c. Wheels	4
	d. Frame	1 set
5	Clamp & Release Mech.	1
6	Hoist	1
7	Speed sensor	1
8	Specimen	
9	Load cell	1
10	Data Acquisition System	1
11	Computer	1

Fig. 1. Schematic drawing and picture of the dropped weight impact machine

3. Test Procedure and Data Processing

During the impact test, the speed and the mass of the impactor were determined according to the estimated energy absorption capacity of each column. Since mechanical properties of aluminum alloy is not strain rate dependent, a small variation of impact speed was acceptable.

The tests were carried out to evaluate the effect of filling the aluminum foam to the single-walled and double-walled column. The parameters to be considered were the instantaneous and the

mean crushing force. The mean crushing force, P_m , is calculated from the instantaneous or the measured crushing force, P , as follows:

$$P_m(x) = \frac{1}{x} \int_0^x P(x) dx, \tag{1}$$

where x is the displacement of the column. From the crushing force vs displacement curve, the energy absorbed by the columns, E_a , can be calculated as the area under the P vs x curve:

$$E_a = \int_0^\delta P(x) dx, \tag{2}$$

where δ is the maximum displacement of the column.

The geometrical imperfections of the columns, one of the parameters affecting the high values of the first peak force, were not measured. Since the columns were prepared using the same batch of material and similar process, it is assumed that they had similar geometrical imperfections. Based on this assumption, the difference between the values of the first peak crushing forces of the column without and with foam is considered as the effect of filling the foam into the columns.

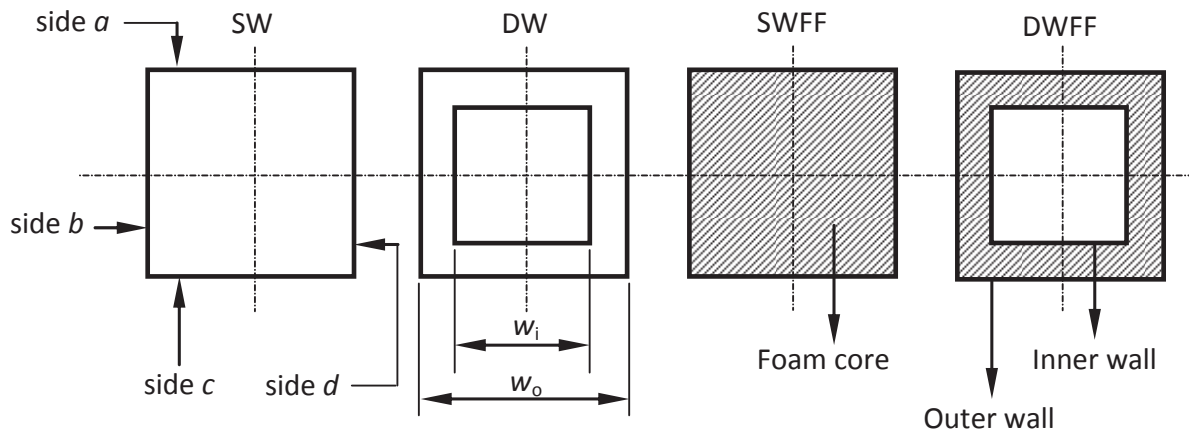

		SW & SWFF		DW & DWFF			
		t (mm)	w (mm)	t_o (mm)	w_o (mm)	t_i (mm)	w_i (mm)
Side	a	1.30	55.00	1.30	55.00	1.15	38.00
	b	1.30		1.30		1.15	
	c	1.10		1.10		1.15	
	d	1.00		1.00		1.15	

Note: all columns are 180 mm long.

Fig. 2. Geometry of Single-walled (SW), Double-walled (DW), Single-walled foam-filled (SWFF), and Double-walled foam-filled (DWFF) columns

4. Results and Analysis

4.1. Deformation Modes

Figure 3 shows the pictures of the columns under axial crushing loads which were taken using a camera with the speed of 1200 fps. It can be seen that for the columns without foam, the SW and DW column, the columns fold progressively from the upper end. For the SW column, a small deformation occurred at its lower end, however, it did not grow into a complete fold. For the SWFF and DWFF column, the columns fold progressively from the upper and lower end. The pictures show that the foams help the formation of the folds from both ends. This explains why the force to start the deformations of the foam-filled column is lower than that of the column without foam.

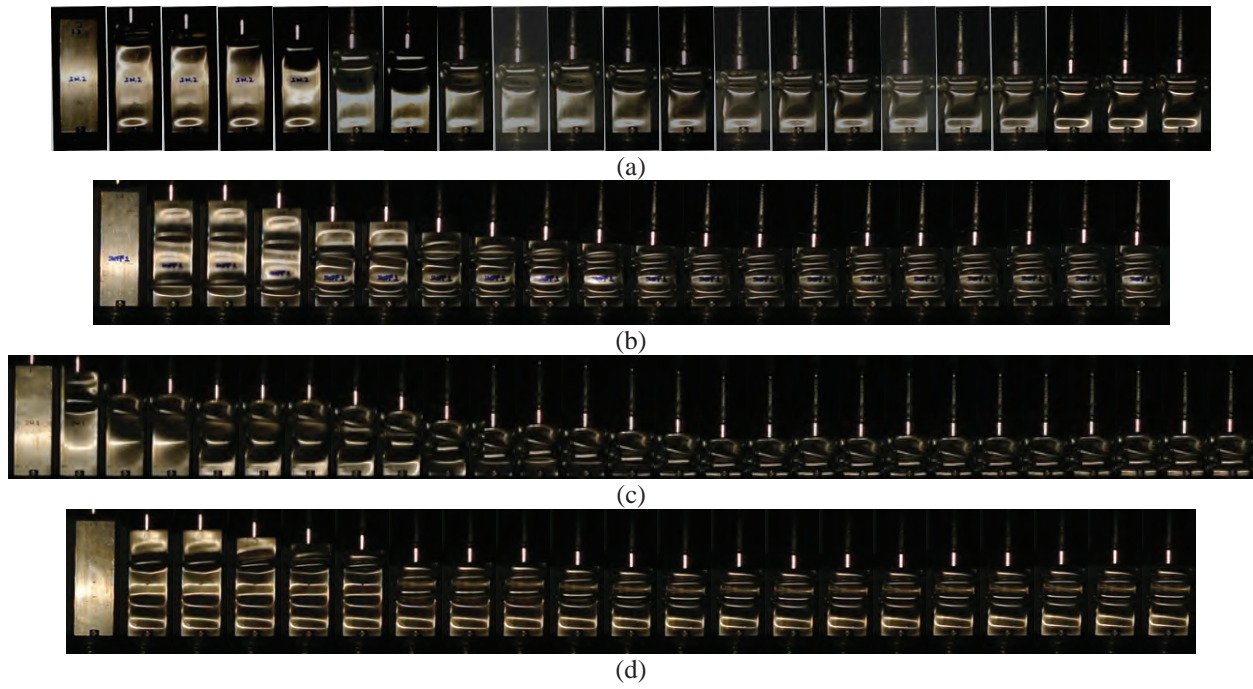

Fig. 3. Pictures (1200 fps) of deformation during the crushing tests of (a) SW, (b) SWFF, (c) DW, (d) DWFF column

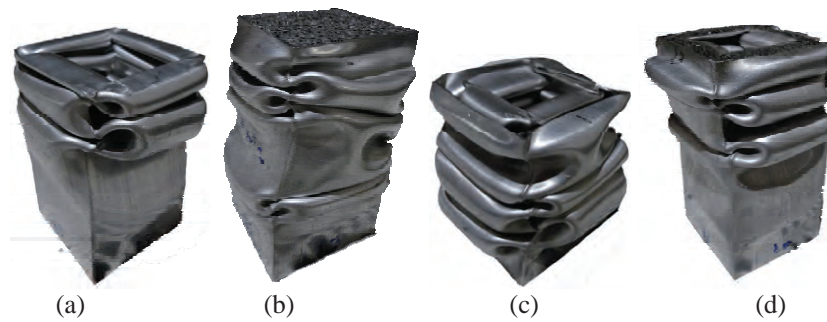

Fig. 4. Plastic deformation modes of (a) SW, (b) SWFF, (c) DW, and (d) DWFF column from experiments

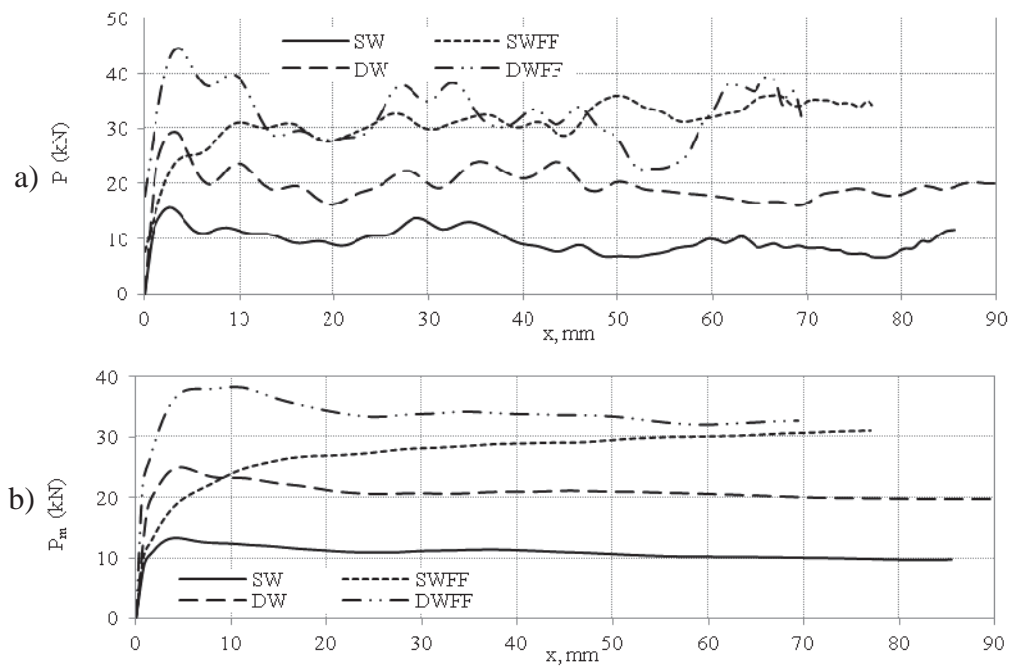

Fig. 5. (a) Instantaneous and (b) mean crushing force of SW, SWFF, DW, DWFF column

Tab.1. Test parameters and results

Column	Impactor			Deformation			
	Mass (kg)	Velocity (m/s)	Energy (kJ)	P_{max} (kN)	P_{mean} (kN)	δ (mm)	Energy (kJ)
SW	45.50	6.10	0.85	16.00	9.76	85.46	0.83
SWFF	75.63	7.95	2.39	36.13	31.10	77.02	2.30
DW	75.63	7.73	2.26	29.53	19.99	112.75	2.25
DWFF	75.63	7.80	2.30	44.69	32.72	69.54	2.27

Figure 4 shows the final deformations of the SW, DW, SWFF, and DWFF column, which are not symmetric due to non-uniform wall thickness of the outer columns. It can be observed that the first fold of SW column is an asymmetric plastic deformation mode in which three sides of the walls fold outwards and one wall fold inward. The next folds are the inextensional modes, where two opposite column walls fold inward and the other two walls fold outward. The first fold of the DW, SWFF and DWFF column is also an asymmetric mode, and the following folds are the inextensional modes. All columns start to fold in asymmetric modes, but after that they fold in inextensional modes that have lower crushing forces.

4.2. Crushing Forces

Figure 5 shows the instantaneous and the mean crushing forces of the SW, DW, SWFF, and DWFF column. It can be seen that the crushing force level of SW column is the lowest, followed by DW, SWFF, and DWFF column. The kinetic energy of the impactor is almost fully absorbed by the column as shown in Tab. 1. It can be observed, by comparing results of the SW and the DW column, that the crushing force of DW column is more than twice that of SW column although the DW column is made by inserting a smaller column inside SW column. This result shows that interaction between the outer and inner column makes the crushing forces of the DW column is higher than the sum of the crushing force of the outer and inner column alone.

By comparing results of the SW to the SWFF and the DW to the DWFF column, it can be seen that filling the foam inside the column increases the crushing resistance force of the column. The increase of mean crushing force is more than 3 times for single walled cell, while for double-walled column the increase is about 1.5 times. For the single walled column, filling the foam also removes the high first peak force. For the double walled column, it reduces the ratio of first peak force to mean force from 1.48 (29.53 kN/19.99 kN) to 1.37 (44.69 kN/32.72 kN). It is estimated that the amount of foam for the DWFF column is too small and hence the interaction between the inner and outer wall still influences the crushing resistance behavior of DWFF column.

4.3. Finite Element Analysis

Based on the results of the experiments, finite element model were developed using explicit finite element software package. The typical finite element model of the column is shown in Fig. 6. The lower end of the column model was fixed and its upper end was loaded in axial direction by a rigid moving block. The mass and initial velocity of the block were set according to the values of these parameters in the experiments as shown in Tab. 1. The column walls were modeled by using Belytschko-Lin-Tsay-4-node-thin shell elements, with its material behaviour was described by using a piecewise linear plasticity model. After performing some convergence tests, the element size of 2×2 mm was found to be sufficient and suitable to simulate the plastic deformation modes of the columns. Following the extensive study of Hanssen et al. [13], the metal foam was modelled as the crushable foam material which was found to perform relatively well with good computational efficiency.

Four different type of contact algorithms were used in the model. The first was the automatic nodes to surface contact which was used to model the interactions between the rigid impactor and

the column. The second was the automatic single surface contact which was used to handle self-contacts of the column wall due to folding deformation. The third was the automatic surface to surface contact to simulate the contact between the column wall and the aluminum foam. The fourth was the interior contact which was used to prevent the occurrence of volumetric error in foam-filled solid model. For the automatic nodes to surface contact, the static coefficient of friction μ_s was 0.61 and dynamic coefficient of friction μ_d was 0.47. The detailed development of the finite element model can be found in [14].

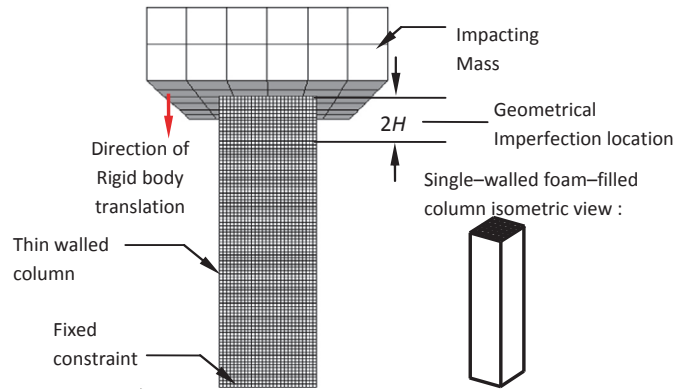

Fig. 6. Typical finite element model of (a) SW, (b) SWFF, (c) DW, (d) DWFF column

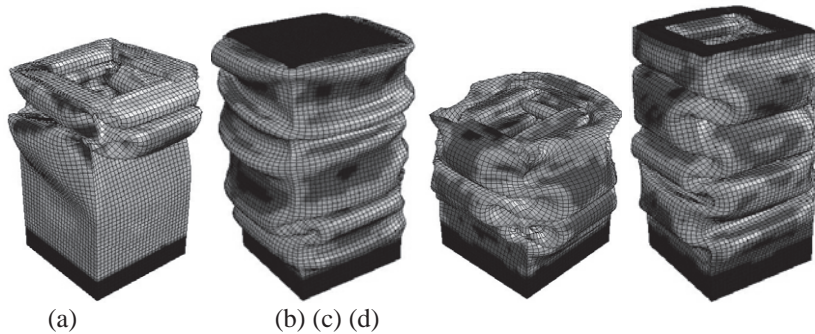

Fig. 7. Deformation modes of SW, SWFF, DW, and DWFF column from finite element analysis

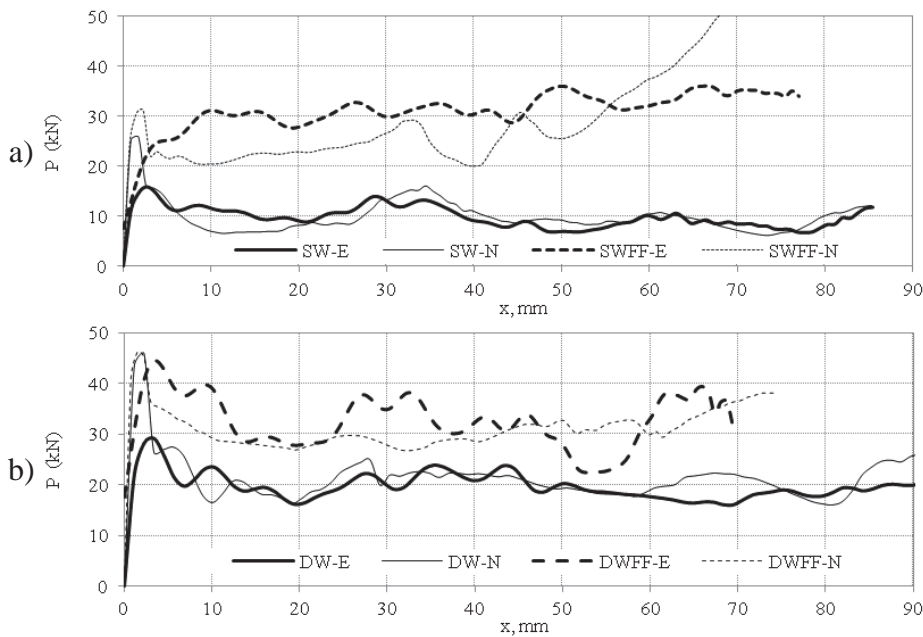

Fig. 8. Instantaneous crushing force from finite element analysis (N) and from the experiments (E) of (a) SW and SWFF column, and (b) DW DWFF column

Tab. 2. Experimental and numerical analysis results of SW, DW, SWFF, and DWFF column

	P_{\max} (kN)		δ_{\max} (mm)		E_A (kJ)		P_m (kN)		
	E	N	E	N	E	N	E	N	Δ (%)
SW	16.00	26.14	85.46	85.27	0.83	0.85	9.76	9.93	1.74
DW	29.53	45.93	112.75	110.99	2.25	2.39	19.99	21.55	7.80
SWFF	36.13	67.96	77.02	74.93	2.30	2.26	31.10	30.14	3.08
DWFF	44.69	46.89	69.54	74.12	2.27	2.30	32.72	31.06	5.07

*E: experimental, N: numerical

The deformations of the columns as the results of the finite element analysis are shown in Fig. 7. By comparing Fig. 7 to Fig. 4, excellent agreements can be seen on the overall shape of all deformed columns. The number of folds in the numerical result is also the same as that of the experiment. The numerical crushing force (P and P_m) of the SW, DW, SWFF, and DWFF column are presented in Fig. 8. The parameters of the experiments and simulations are presented in Tab. 2. These results show good agreement between them. This means that the crushing of the four columns can be well simulated by using the finite element analysis.

5. Conclusions

Experimental study of foam filled columns under axial loading has been carried out for single-walled and double-walled column. For single-walled column, filling the empty space with aluminum foam increases its crushing resistance force by a factor of 3, and removes the high first crushing force peak. Similar effects are also found for the double-walled column, although not as significant as in the case of single walled column. For the double-walled column, filling the empty space with aluminum foam increases its crushing resistance force by a factor of 1.5, and reduces the ratio of the high first crushing force peak to the mean force from 1.48 to 1.37.

The experimental crushing characteristics of the columns can be well simulated using the finite element model which has been developed based on the geometry and the material properties of the columns.

References

- [1] Thornton, P., *Energy Absorption by Foam-filled Structures*, SAE paper 800081, 1980.
- [2] Niknejad, A., Liaghat, G. H., Moslemi, N. H., Behraves, A. H., *Theoretical and Experimental Studies of the Instantaneous Folding Force of the Polyurethane Foam-Filled Square Honeycombs*, Materials and Design, Vol. 32, Is. 1, pp. 69-75, 2011.
- [3] Niknejad, A., Abedi, M. M., Liaghat, G. H., Nejad, M. Z., *Prediction of the Mean Folding Force during the Axial Compression in Foam-Filled Grooved Tubes by Theoretical Analysis*, Materials and Design, Vol. 37, pp. 144-151, 2012.
- [4] Macaulay, M.A., *Introduction of Impact Engineering*, Chapman and Hall, 1987.
- [5] Adziman, F., Dirgantara, T., Inoue, H., Kishimoto, K., Hashimura, T., *The Effects of Inhomogeneity on the Buckling Behavior of Metal Foams*, Proceeding of MetFoam2005 Conference, Kyoto, Japan 2005.
- [6] Jones, N., *Structural Impact*, Cambridge University Press 1989.
- [7] Rohr, I., Nahme, H., Thoma, K., *Material Characterization and Constitutive Modelling of Ductile High Strength Steel for a Wide Range of Strain Rates*, International Journal of Impact Engineering, Vol. 31, pp. 401-433, 2005.

- [8] Santosa, S. P., Wierzbicki, T., Hanssen, A. G., Langseth, M., *Experimental and Numerical Studies of Foam-Filled Sections*, International Journal of Impact Engineering, pp. 509-534, 1999.
- [9] Seitzberger, M., Rammerstorfer, F.G., Gradinger, R., Degischer, H.P., Blaimschein, M., Walch, C., *Experimental Studies on the Quasi-Static Axial Crushing of Steel Columns Filled with Aluminium Foam*, International Journal of Solids and Structures, Vol. 37, pp. 4125-4147, 2000.
- [10] Santosa, S., Wierzbicki, T., *The Concept of Double-Walled Sandwich Columns for Energy Absorption*, International Journal of Crashworthiness, Vol. 4, Is. 2, 1999.
- [11] Zhang, Y., Sun, G., Li, G., Luo, Z., Li, Q., *Optimization of Foam-Filled Bitubal Structures for Crashworthiness Criteria*, Materials and Design, Vol. 38, pp. 99-109, 2012.
- [12] Gunawan, L., Dirgantara, T., Putra, I.S., *Development of a Dropped Weight Impact Testing Machine*, International Journal of Engineering and Technology IJET-IJENS, Vol. 11:06, pp. 120-126, 2011.
- [13] Hanssen, A. G., Hopperstad, O. S., Langseth, M., Ilstad, H., *Validation of Constitutive Models Applicable to Aluminum Foams*, International Journal of Mechanical Sciences, Vol. 44, pp. 359–406, 2002.
- [14] Jusuf, A., *Crashworthiness Analysis of Multi-Cells and Double-Walled Foam-Filled Prismatic Structures under Axial Loading*, Doctoral Dissertation, Institut Teknologi Bandung 2013.

