

L. ŘEHÁČKOVÁ\*<sup>#</sup>, S. ROSYPALOVÁ\*, R. DUDEK\*, M. RITZ\*, D. MATÝSEK\*\*, B. SMETANA\*, J. DOBROVSKÁ\*, S. ZLÁ\*, M. KAWULOKOVÁ\*

## EFFECT OF CHEMICAL COMPOSITION AND TEMPERATURE ON VISCOSITY AND STRUCTURE OF MOLTEN CaO-Al<sub>2</sub>O<sub>3</sub>-SiO<sub>2</sub> SYSTEM

### WPLYW SKŁADU CHEMICZNEGO I TEMPERATURY NA LEPKOŚĆ I STRUKTURĘ CIEKŁEGO UKŁADU CaO-Al<sub>2</sub>O<sub>3</sub>-SiO<sub>2</sub>

The effects of the change of chemical composition and temperature on the viscosity of CaO-Al<sub>2</sub>O<sub>3</sub>-SiO<sub>2</sub> oxide system with basicity from 0.78 to 1.63 were investigated in this paper. Experimental measurements of viscosity were performed with use of the high-temperature viscometer Anton Paar FRS 1600. Viscosity was measured in a rotational mode during heating at the rate of 2.2 K/min in the temperature interval from 1673 to 1873 K. Viscosity is often sensitive to the structural changes in molten oxide systems, which implies that the analysis of viscosity is an effective way to understand the structure of molten oxide systems. Exact clarification of the change of structure of the oxide system caused by increased content of CaO was performed by Fourier transform infrared spectroscopy (FTIR), Raman spectroscopy and X-ray diffraction (XRD).

*Keywords:* CaO-Al<sub>2</sub>O<sub>3</sub>-SiO<sub>2</sub> system, viscosity, basicity, structure of slag

W artykule badano wpływ zmian składu chemicznego i temperatury na lepkość układu tlenków CaO-Al<sub>2</sub>O<sub>3</sub>-SiO<sub>2</sub> o zasadowości od 0.78 do 1.63. Pomiar doświadczenia lepkości przeprowadzono z użyciem wiskozymetru wysokotemperaturowego Anton Paar FRS 1600. Lepkość mierzono w układzie obrotowym w czasie ogrzewania z szybkością 2.2 K/min w zakresie temperatur 1673-1873 K. Lepkość jest często wrażliwa na zmiany strukturalne w ciekłych układach tlenkowych, co oznacza, że analiza lepkości jest skutecznym sposobem, aby zrozumieć strukturę układu ciekłych tlenków. Przeprowadzono dokładne wyjaśnienie zmiany struktury systemu tlenków spowodowane zwiększeniem zawartości CaO przy użyciu metody FTIR (Fourier transform infrared spectroscopy), spektroskopii Ramana i XRD (X-ray diffraction).

### 1. Introduction

The molten inorganic oxide systems, including metallurgical slag and casting powders, represent from the physico-chemical point of view complicated polycomponent systems. These systems consist mainly of oxides of certain components of the metal charge, oxidation, or fluxes and other products obtained in the reaction between the molten metal and the refractory material. The chemical composition and temperature substantially affect their structure.

The ternary CaO - Al<sub>2</sub>O<sub>3</sub> - SiO<sub>2</sub> slag system is very important technologically in a wide range of applications including ironmaking, steelmaking and ceramics processing. Knowledge of the structure of silicate melts is very important, it is the dominant factor affecting the transport properties, such as viscosity [1]. The main building block in a silicate melt is SiO<sub>4</sub><sup>4-</sup> tetrahedron. If the SiO<sub>4</sub><sup>4-</sup> tetrahedra are linked to each other by Si-O-Si linkages where one oxygen connects two neighbouring tetrahedra, then the oxygen is defined as bridging (BO). A bridging oxygen can also bridge to tetrahedrally coordinated cations such as Al<sup>3+</sup>, Fe<sup>3+</sup>, Ti<sup>4+</sup> or P<sup>5+</sup>, which are called a network

forming cations. These cations can form tetrahedra that may fit in the silicate network and enhance the polymerization of the melt. Higher concentrations of acidic oxides polymerize the slag producing complex silicate structures, which increase the slag viscosity. In addition to network formers, cations are also network modifiers as for example K<sup>+</sup>, Na<sup>+</sup>, Ca<sup>2+</sup>, Mg<sup>2+</sup> and Fe<sup>2+</sup>, which are octahedral coordinated. When an oxygen connects with a cation that is not tetrahedrally coordinated, then it is called a non-bridging oxygen (NBO). Higher concentrations of basic oxides depolymerise the network structure of the slag and the viscosity decreases [2, 3].

Detailed information on the structure of the silicate melts is important to understand the dynamic process of the viscous flow [4]. In recent years, significant efforts have been devoted to the study of the structure of silicate melts using of different methods such as X-ray, neutron diffraction, Raman spectroscopy, Fourier transform infrared spectroscopy (FTIR) or nuclear magnetic resonance. While the knowledge gained from these studies has improved understanding of the short-range structure and the relationship between structure and various properties of silicate melts, it is still limited to certain

\* VŠB-TECHNICAL UNIVERSITY OF OSTRAVA, FACULTY OF METALLURGY AND MATERIALS ENGINEERING, 17. LISTOPADU 15/2172, OSTRAVA-PORUBA, CZECH REPUBLIC,

\*\* VŠB-TECHNICAL UNIVERSITY OF OSTRAVA, FACULTY OF MINING AND GEOLOGY, 17. LISTOPADU 15/2172, OSTRAVA-PORUBA, CZECH REPUBLIC

<sup>#</sup> Corresponding author: lenka.rehackova@vsb.cz

composition ranges for a small number of binary or ternary silicate systems and cannot be readily used to describe the behavior of multicomponent melts.

Due to this lack of data regarding structure of silicate melts, the aim of this work is to determine the dependence of viscosity on temperature and on concentration of CaO for the ternary system CaO-Al<sub>2</sub>O<sub>3</sub>-SiO<sub>2</sub>. The influence of structure on viscosity changes was studied using Raman spectroscopy, Fourier transform infrared spectroscopy (FTIR) and X-ray diffraction (XRD).

## 2. Experimental research

### 2.1. Preparation of the samples

The ternary oxide system CaO-Al<sub>2</sub>O<sub>3</sub>-SiO<sub>2</sub> (TS) was selected for this experimental study. A concentration series with the addition of 3; 6; 9; 10; 11; 12; 15 and 18 wt. % of CaO were prepared for an assessment of the influence of the change of the chemical composition and temperature on viscosity and structure of this oxide system. The samples were prepared from pure components and synthesized using the following reagent-grade chemicals: CaO (99.5 pct), Al<sub>2</sub>O<sub>3</sub> (99 pct) and SiO<sub>2</sub> (99.5 pct). Chemical composition of the samples is shown in Table 1.

TABLE 1  
Chemical composition of the concentration series [wt.%]

samples	SiO <sub>2</sub>	CaO	Al <sub>2</sub> O <sub>3</sub>	B
TS	47.20	36.90	15.90	0.78
TS + 3 wt. % CaO	44.96	39.90	15.14	0.89
TS + 6 wt. % CaO	42.71	42.90	14.39	1.00
TS + 9 wt. % CaO	40.47	45.90	13.63	1.13
TS + 10 wt. % CaO	39.72	46.90	13.38	1.18
TS + 11 wt. % CaO	38.97	47.90	13.12	1.23
TS + 12 wt. % CaO	38.22	48.90	12.88	1.28
TS + 15 wt. % CaO	35.98	51.90	12.12	1.44
TS + 18 wt. % CaO	33.74	54.90	11.36	1.63

Note: B (basicity) = CaO/SiO<sub>2</sub>

### 2.2. Measurements of dynamic viscosity

The viscosity measurements were carried out by the rotating viscometer Anton Paar FRS 1600 (see Fig. 1) [5]. This viscometer is a combination of laboratory furnace and measuring head DSR 301 on the basis of air bearings. The rheometer is air-cooled in order to protect its electronic components from overheating. The measuring system consists of a graphite spindle (cone shaped) mounted on a long ceramic shaft connected to the rheometer head, and of graphite crucible, which is fixed to the lower side of the ceramic shaft.

This instrument measures the torque of graphite spindle rotating in graphite crucible filled with oxide melt. The speed range of the spindle is 0-200 rpm. A high temperature furnace system with a maximum temperature of 1873 K monitored

by a Pt-13%Rh/Pt thermocouple was used in the instrument. The graphite crucible containing 55 g of the oxide system was placed into the furnace. In order to avoid the oxidation of graphite crucible and spindle, the nitrogen gas (purity > 99.9999) was used at a flow rate of 250 l/h. The furnace was heated to 1673 K at the heating rate of 15.3 K/min and held for 30 min to stabilize the temperature and homogenize the oxide melt. The graphite spindle was then immersed into the oxide melt.

The viscosity was measured during heating up to 1873 K at the heating rate of 2.2 K/min.

On the basis of measurements of viscosity dependence on the shear rate an optimum shear rate of 85 s<sup>-1</sup> was chosen for the viscosity measurement.



Fig. 1. Viscometer Anton Paar FRS 1600

### 2.3. Determination of structure

The structural characteristics of the selected samples were determined by Fourier transform infrared spectroscopy (FTIR), Raman spectroscopy and X-ray diffraction (XRD). The samples TS; TS + 9 wt. % CaO and TS + 18 wt. % CaO were prepared by quench cooling. This method allows very rapid cooling of the investigated system at certain stage of melting.

The basic structural unit of the equipment (Fig. 2) consists of the Tamman resistance furnace, the working workspace of which contains a rotary system with graphite crucibles with the investigated melt. It is essentially a turret system, the turning of which causes a fall of crucible with the melt into liquid nitrogen placed under the working space of the furnace, followed by immediate freezing of the melt and thus to fixation of the phases corresponding to the temperature of the sample before its fall. The temperature during the experiment was determined by thermocouple of the type B (Pt Rh), furnace working space was filled with argon. The heating rate was 5 K/min. In this manner, samples were prepared at the temperature of 1803 K.

The samples were then mechanically disintegrated, homogenized and subjected to given analysis already at normal temperature.

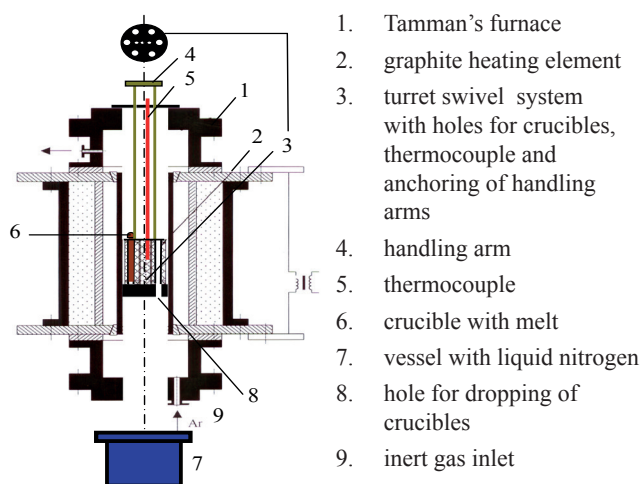

Fig. 2 Diagram of equipment designated for shock cooling of the melt.

The infrared spectroscopy of the powder samples was performed on the FTIR spectrometer Nexus 470 (ThermoScientific, USA). IR spectra were measured by potassium bromide pellets technique. Exactly 5.0 mg of sample was ground with 200 mg dried potassium bromide. This mixture was used to prepare the potassium bromide pellets. The pellets were pressed by 8 tons for 30 seconds under vacuum. Measurement parameters of IR spectra were the following: spectral region 4000-400  $\text{cm}^{-1}$ , spectral resolution 4  $\text{cm}^{-1}$ ; 64 scans; Happ-Genzel apodization. Treatment of spectra: polynomial (second order) baseline, subtraction spectrum of pure potassium bromide.

Raman spectroscopy of all above mentioned samples was performed on the dispersive Raman spectrometer DXR SmartRaman (ThermoScientific, USA). A 180° degree sampling was used as measurement technique. The samples were measured without any treatments. The measurement parameters were as follows: excitation laser 780 nm, grating 400 lines/mm, aperture 50  $\mu\text{m}$ , exposure time 1 second, number of exposures 500, and spectral region 3400 -50  $\text{cm}^{-1}$ . An empty sample compartment was used for background measurement. Treatment of spectra: fluorescence correction (6<sup>th</sup> order).

X-ray diffraction phase analysis of all above mentioned samples was performed already at ambient temperature on refurbished, fully automated diffractometer URD-6 (Rich. Seifert-FPM, SRN) under the following conditions:

- Radiation  $\text{CoK}\alpha/\text{Ni}$  filter, voltage 40kV, current 35 mA, step mode with a step of 0.05°  $2\theta$  with time of the step of 3s and with digital processing of the resulting data. A proprietary program RayfleX (RayfleX ScanX and RayfleX Analyze, version 2.289) was used both for measurement and for evaluation.
- For qualitative assessment the database of diffraction data PDF-2, version 2001 (International Centre for Diffraction Data, Pennsylvania, USA) was furthermore used.
- For semi-quantitative analysis the program RayfleX Autoquan version 2.6 was used.

### 3. Results and discussion

#### 3.1. Normal force

Individual samples weighing 55 g were heated in a graphite crucible to the temperature of 1673 K at the rate of 15.3 K/min. During heating normal force was measured while acting on the surface of the investigated systems. The curves of dependence of the normal force on the temperature for the basic ternary system (TS) and for the system (TS + 15 wt. % CaO) are shown in Fig. 3.

It is evident from this Figure that within the temperature range from 873 to 1233 K the normal force increases due to the volume expansion of the sample. At the temperature of 1653 K the normal force decreases to zero, it means that the system is in the liquids phase. Conversely trend of normal force for the system with the addition of 15 wt. % of CaO does not increase the axial forces due to expansion of the sample in the entire temperature interval.

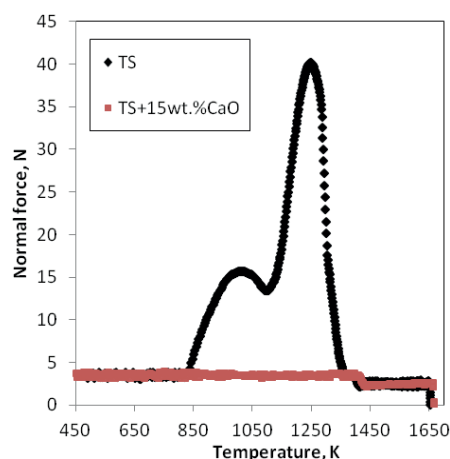

Fig. 3. Temperature dependence of normal force of the ternary system (TS) and system TS+15 wt. % CaO during heating

Similar temperature dependencies of the axial forces as for the basic ternary system (TS) were obtained in almost all the systems in the studied concentration range. It was determined from these dependences that while the basic ternary system (TS) was melted throughout its whole volume at the temperature of 1673 K, the remaining systems of the concentration series were melted at the temperature of 1703 K. System TS + 18 wt.% CaO was melted at the temperature 1773 K.

#### 3.2. Dynamic viscosity temperature dependence

Dynamic viscosity temperature dependences of all the measured systems are shown in Figs. 4-6. Fig. 4 shows the temperature dependences of the systems with additions of 0; 3; 6 and 9 wt. % of CaO (TS, TS + 3 wt. % CaO, TS + 6 wt. % CaO and TS + 9 wt. % CaO) measured during heating (1700 K – 1850 K). Fig. 5 shows these dependences for the systems enriched with 10; 11; 12 and 15 wt. % of CaO (TS + 10 wt. % CaO, TS + 11 wt. % CaO, TS + 12 wt. % CaO and TS + 15 wt. % CaO) measured during heating, too. Fig. 6 shows the temperature dependence of the system with

additions of 18 wt. % of CaO (TS + 18 wt. % CaO) measured during heating (1773 K – 1830 K). Basing on these figures it can be stated that viscosity of the systems decreases exponentially with the increasing temperature. In the systems with additions of 3, 6, and 9 wt. % of CaO viscosity decreases with the increasing CaO content. With further addition of CaO (TS + 10 wt. % CaO) the viscosity increases (see Figs. 5 and 6). While in the system TS + 9 wt. % CaO the viscosity measured at 1773 K was 0.279 Pa·s, then in the system TS + 10 wt. % CaO the viscosity measured at the same temperature was 0.302 Pa·s. It is therefore valid for the systems with addition of 10; 11; 12; 15 and 18 wt. % of CaO, that viscosity with the increasing CaO content increases, although in the systems with addition of 11; 12 and 15 wt. %, this trend is less evident.

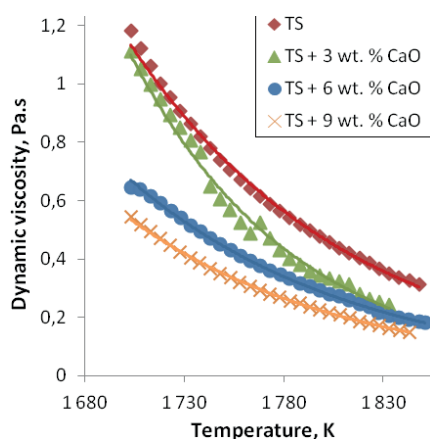

Fig. 4. Temperature dependence of viscosity of the systems with additions of 0; 3; 6 and 9 wt. % of CaO (TS, TS + 3 wt. % CaO, TS + 6 wt. % CaO and TS + 9 wt. % CaO) during heating

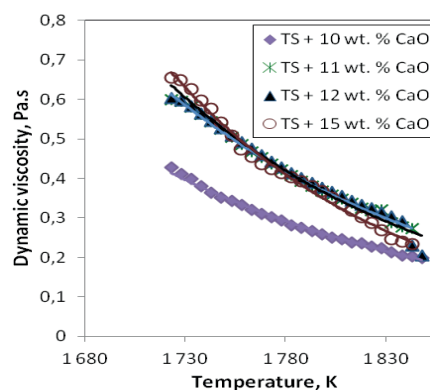

Fig. 5. Temperature dependence of viscosity of the systems with additions of 10; 11; 12 and 15 wt. % of CaO (TS + 10 wt. % CaO, TS + 11 wt. % CaO and TS + 12 wt. % CaO and TS + 15 wt. % CaO) during heating.

### 3.3. Influence of the change of chemical composition and basicity on dynamic viscosity and structure

Change of the chemical composition of oxide systems has a significant impact on their viscosity. Basicity of these systems is changing with the addition of CaO. Precise values expressing the dependence of viscosity on the concentration of CaO and basicity at the constant temperature 1803 K are given in Table 2.

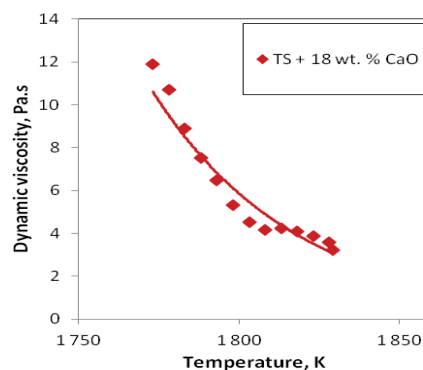

Fig. 6. Temperature dependence of viscosity of the system with additions of 18 wt. % of CaO (TS + 18 wt. % CaO) during heating

TABLE 2  
Dependence of dynamic viscosity on CaO concentration and basicity at the constant temperature (1803 K)

samples	wCaO	CaO/SiO <sub>2</sub>	$\eta$ [Pa.s]
TS	0.369	0.78	0.457
TS + 3 wt. % CO	0.399	0.89	0.332
TS + 6 wt. % CaO	0.429	1.00	0.281
TS + 9 wt. % CaO	0.459	1.13	0.216
TS + 10 wt. % CaO	0.469	1.18	0.251
TS + 11 wt. % CaO	0.479	1.23	0.358
TS + 12 wt. % CaO	0.489	1.28	0.366
TS + 15 wt. % CaO	0.519	1.44	0.352
TS + 18 wt. % CaO	0.549	1.63	4.6

It is evident from this table that viscosity initially decreases with the increasing basicity, i. e. with the viscosity ratio CaO/SiO<sub>2</sub>, while it achieves its minimum value approximately at the CaO/SiO<sub>2</sub> ratio = 1.13. At the higher values of the CaO/SiO<sub>2</sub> ratio the values of viscosity again increase. The basicity influence on the slag viscosity value is much more pronounced at lower temperatures. This effect is reduced with the increasing temperature.

Effect of basicity on the viscosity of molten oxide system can be broadly interpreted as follows: the higher the viscosity, the larger size of complex anions.

The basic building unit of silicates, aluminium silicates and other modifications of SiO<sub>2</sub> is the tetrahedron SiO<sub>4</sub><sup>4-</sup>, which consists of small central atom of silicon, surrounded by four large atoms of oxygen situated at the vertices of the tetrahedron. Those tetrahedrons can exist in the structure of silicates as independent structural units, or they can be mutually interconnected into more complex formations, while connection of tetrahedrons is realised by sharing of one atom of oxygen, the so called oxygen bridge, by two adjacent tetrahedrons. Anionic units of the type [Si<sub>2</sub>O<sub>5</sub>]<sup>2-</sup>, [Si<sub>2</sub>O<sub>6</sub>]<sup>4-</sup>, [Si<sub>2</sub>O<sub>7</sub>]<sup>6-</sup> and [SiO<sub>4</sub>]<sup>4-</sup> occur in the silicate melts [2].

Breaking of compound silicate complexes to simpler ones causes on the contrary decrease of viscosity reduction [6, 7]. However, at higher temperatures, thanks to partial defragmentation of silicate complexes is less evident impact of defragmentation associated with the modifying effect of CaO for the silicate bond.

According to the above statements increasing content of CaO in silicate melts should thus always lead to declines

of the viscosity values. However, the experiments show that viscosity decreases with the increase of CaO content (with the increasing basicity) only to a certain limiting concentration of CaO. Viscosity reaches its minimum value at the ratio  $\text{CaO}/\text{SiO}_2 = 1.13$ . Another addition of CaO leads to re-increase in the viscosity of melts. In this case it is necessary to take into account also the radii of individual ions present in the melt and the strength of covalent and ionic bonds within the individual oxides.

It is generally valid that: the higher the positive charge of the ion, the smaller its radius. Moreover for atomic radii it is valid that in the periods the ion radius decreases, since the effective charge of the core is increasing, which causes a higher concentration of electron envelope. This trend applies also to the ions of the same valence. Within the frictional forces between the particles (assuming their spherical shape) the particles with larger radius necessarily increase the value of melt viscosity. According to the above rules ion radius increases in the following order:  $\text{Si}^{4+} \rightarrow \text{Al}^{3+} \rightarrow \text{Mg}^{2+} \rightarrow \text{Ca}^{2+}$ . If it omits the associated character of the melt, then increasing of the CaO content must necessarily lead to an increase in viscosity. Therefore, in the studied system, it is possible to meet two opposing effects - CaO decreases the associated character of the melt due to influence of its modification effects, or it reduces the viscosity melt, and at the same time it increases the viscosity by effect of its ionic radius. On the basis of the realised experiments a break in its influence on the overall viscosity of the melt occurs at the basicity value around  $\text{CaO}/\text{SiO}_2 = 1.13$ . [8]

It is evident from Table 2 that the trend of viscosity values changes in dependence on the change of chemical composition around the sample with basicity of 1.13. Thus the samples with basicity of 0.78; 1.13 and 1.63 (TS; TS + 9 wt.% CaO and TS + 18 wt.% CaO) were subjected to infrared spectroscopic analysis, Raman spectroscopy and X-ray diffraction (XRD).

FTIR spectroscopy allows differentiation of the various types of bonds in the material to be analysed at the molecular level. The resulting spectra are shown in Fig. 7. Characteristic bands for silicate systems can be observed in the FTIR spectra in the wavenumber region between 1 200 and 400  $\text{cm}^{-1}$  [9]. This region generally represents the symmetric Si-O stretching vibration bands of the  $[\text{SiO}_4]^{4-}$  tetrahedral at about 1170-760  $\text{cm}^{-1}$  [10, 11], the asymmetric stretching vibrations of  $[\text{AlO}_4]^{4-}$  tetrahedral at about 750-630  $\text{cm}^{-1}$  [10, 12, 13], and the symmetric Si-O-Al bending vibration bands at about 630-400  $\text{cm}^{-1}$ .

As can be seen in Fig. 7, the course of all the infrared spectra achieved is based on presence of broad and non-sharp bands, which confirms amorphous character of all the studied samples. The sample TS + 18 wt. % has at least amorphous character. The spectra contain three main relatively broad bands belonging to various vibrations of Si - O and Al - O bonds. The most intense band around 930  $\text{cm}^{-1}$  may be attributed to the asymmetrical stretching vibrations of O - Si - O bonds in  $\text{SiO}_4$  tetrahedrons. The lower limit of the  $[\text{SiO}_4]^{4-}$  tetrahedral bands at about 1170-760  $\text{cm}^{-1}$  shifts to a lower wavenumber from about 830 to 750  $\text{cm}^{-1}$  with an increase in basicity of the oxide system 0.78 to 1.63. Peak of  $[\text{AlO}_4]^{4-}$  tetrahedral dampens with increasing basicity. Bands near 500  $\text{cm}^{-1}$  are typical for the Si - O - Si rocking vibrations, which indicate structured complex silicate structures [9].

FTIR spectroscopy was supplemented by the Raman spectroscopy. The resulting Raman spectra for the samples with basicity of 0.78; 1.13 and 1.63 (TS; TS + 9 wt. % CaO and TS + 18 wt. % CaO) are shown in Fig. 8.

Results of the X-ray diffraction phase analysis of all investigated samples confirm amorphous character of given samples. Phase larnite-dicalcium silicate was found in the sample TS + 18 wt. % CaO (see Fig. 9). Estimation of the contents of amorphous substances is 43 % in this sample.

#### 4. Conclusions

The results obtained by the experimental research can be summarized as follows:

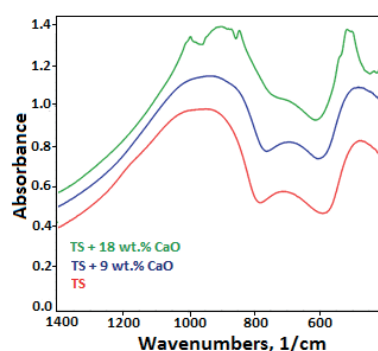

Fig. 7. FTIR spectra of investigated samples (TS, TS + 9 wt. % CaO; TS + 18 wt. % CaO) at temperature 1803 K

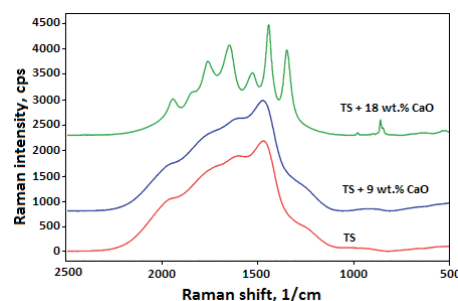

Fig. 8. Raman spectra of investigated samples (TS, TS + 9 wt. % CaO; TS + 18 wt. % CaO) at temperature 1803 K

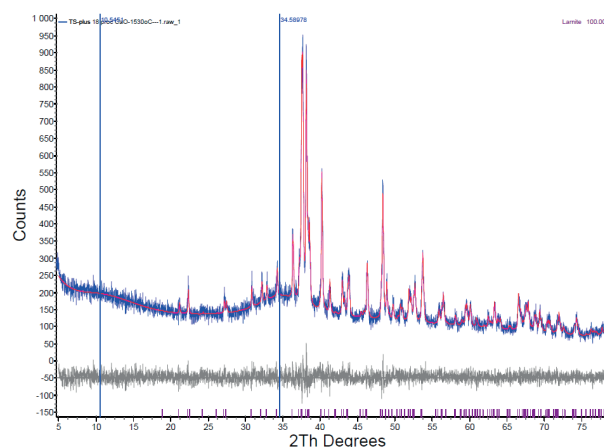

Fig. 9. XRD pattern of the investigated sample TS + 18 wt. % CaO at temperature 1803 K

- Viscosity of all the investigated oxide systems decreases exponentially with the increasing temperature.
- Dynamic viscosity is highly dependent on the chemical composition of the oxide system. Mutual ratio CaO/SiO<sub>2</sub>, i.e. basicity affects significantly the viscosity. Viscosity first decreases with the increasing basicity, while it achieves its minimum value at the CaO/SiO<sub>2</sub> ratio = 1.13. At the higher values of the CaO/SiO<sub>2</sub> ratio the values of viscosity again increase. Effect of basicity on the viscosity value of investigated oxide systems is much more pronounced at lower temperatures.
- Viscosity in the slag systems is determined by the internal structure. At low CaO content, modification effects appear with its gradual increase. Silicate bonds (shift to lower wavenumbers) are often extended or destroyed and viscosity decreases. FTIR analysis suggests that the complex network structures of the oxide systems are depolymerised into simpler and smaller network units for viscous flow, with the increase in basicity of the oxide system. Defragmentation at certain critical concentration of CaO already reached such an extent that further increase of CaO is not decisive in this respect and partial viscosity of CaO is starting to show, which leads to the increase of viscosity in the system.

#### Acknowledgements

This paper was created in the frame of the project No. LO1203 "Regional Materials Science and Technology Centre - Feasibility Program" funded by Ministry of Education, Youth and Sports of the Czech Republic and the student projects SGS (SP2015/88 and SP2015/70).

#### REFERENCES

- [1] J.H. Park, Structure - Property Relationship of CaO-MgO-SiO<sub>2</sub> Slag: Quantitative Analysis of Raman Spectra, *Metall. Mater. Trans. B* **44**, 938–947 (2013).
- [2] K.C. Mills, The Influence of Structure on the Physico-chemical Properties of Slags, *ISIJ Int.* **33**, 148–155 (1993).
- [3] B.O. Mysen, The Structure of Silicate Melts, *Annual Review of Earth and Planetary Sciences* **11**, 75-97 (1983).
- [4] L. Zhang, S. Jahanshahi, Review and Modeling of Viscosity of Silicate Melts: Part I. Viscosity of Binary and Ternary Silicates Containing CaO, MgO and MnO, *Metall. Mater. Trans. B* **29**, 177-186 (1998).
- [5] S. Rosypalová, L. Řeháčková, R. Dudek, J. Dobrovská, B. Smetana, L. Dobrovský, M. Žaludová, Influence of Temperature and SiO<sub>2</sub> Concentration on Viscosity of Molten Oxide Systems, *Hutnické listy* **65**, 15–19 (2012).
- [6] F.A. Cotton, G. Wilkinson, *Advanced Inorganic Chemistry* (5th Edn), New York: Wiley 1988.
- [7] E.T. Turgodogan, *Physicochemical Properties of Molten Slags and Glasses*, London: The Metals Society 1983.
- [8] L. Řeháčková, S. Rosypalová, R. Dudek, J. Dobrovská, Influence of CaO content on viscosity of molten CaO-Al<sub>2</sub>O<sub>3</sub>-SiO<sub>2</sub> system, *Archives of Materials Science and Engineering* **59**, 61–68 (2013).
- [9] H. Kim, H. Matsuura, F. Tsukihashi, W. Wang, D.J. Min, I. Sohn, Effect of Al<sub>2</sub>O<sub>3</sub> and CaO/SiO<sub>2</sub> on the Viscosity of Calcium-Silicate-Based Slags Containing 10 Mass Pct MgO, *Metall. Mater. Trans. B* **44**, 5-12 (2013).
- [10] Y.M. Gao, S.B. Wang, Ch. Hong, X.J. Ma, F. Yang, Effects of basicity and MgO content on the viscosity of the SiO<sub>2</sub>-CaO-MgO-9wt%Al<sub>2</sub>O<sub>3</sub> slag system, *International Journal of Minerals, Metallurgy and Materials* **21**, 353–362 (2014).
- [11] I. Sohn, D.J. Min, A Review of the Relationship between Viscosity and the Structure of Calcium-Silicate-Based Slags in Ironmaking, *Steel Research Int.* **83**, 611–630 (2012).
- [12] J.H. Park, D.J. Min, H.S. Song, Amphoteric Behavior of Alumina in Viscous Flow and Structure of CaO-SiO<sub>2</sub>(-MgO)-Al<sub>2</sub>O<sub>3</sub> Slags, *Metall. Mater. Trans. B* **35**, 269-275 (2004).
- [13] J. Liao, Y. Zhang, S. Sridhar, X. Wang, Z. Zhang, Effect of Al<sub>2</sub>O<sub>3</sub>/SiO<sub>2</sub> Ratio on the Viscosity and Structure of Slags, *ISIJ Int.* **52**, 753-758 (2012).

Received: 20 October 2014.