

TO DETERMINE THE MANEUVERABILITY OF THREE-LINK ROAD TRAINS TYPE “B-TRIPLE” WITH STEERED AXLES OF SEMI-TRAILERS DOLLIES

ROMAN MARCHUK¹, VOLODYMYR SAKHNO², IGOR MUROVANYI³,
OLEKSANDR RAZBOINIKOV⁴, VOLODYMYR BOSENKO⁵, NAZAR MARCHUK⁶

Abstract

In recent years, the development of container transportation served as a powerful impetus for increasing the length of vehicles, especially road trains, which is due to a number of advantages regarding the transportation of large-sized freight in a container.

Today, the whole range of containers is transported by two-link road trains consisting of a tractor vehicle and semi-trailer. The efficiency of such transportation can be increased by means of three-link road trains capable of transporting either three (two 20-foot and one 40- or 45-foot) or four 20-foot containers. This organization of transportation will lead to energy savings and a reduction in environmental pollution due to the reduction of vehicles. However, there is a problem with the maneuverability and stability of such vehicles.

The paper developed a kinematic model of three-link road train type “B-triple” with steered axles (front or rear) of semi-trailer dolly with a dual drive control for these axles. Based on folding angles of road train links and drive control transmission ratios of the axles of semi-trailer dolly, the main indicators of road train maneuverability are determined – road

¹ Department of Automobiles and Automotive industry, National university of water and environmental engineering, Ukraine, e-mail: r.m.marchuk@nuwm.edu.ua, ORCID: 0000-0002-9974-8769

² Automobiles, National transport university, Ukraine, e-mail: sakhno@ntu.edu.ua, ORCID: 0000-0002-5144-7131

³ Faculty of transport and mechanical engineering, Lutsk national technical university, Ukraine, e-mail: igor_lntu@ukr.net, ORCID: 0000-0002-9749-980X

⁴ Automobiles, National transport university, Ukraine, e-mail: razboyn1k@ukr.net, ORCID: 0000-0003-3024-0999

⁵ Automobiles, National transport university, Ukraine, e-mail: bosia4ok@ukr.net, ORCID: 0000-0002-9654-949X

⁶ Department of Automobiles and Automotive industry, National university of water and environmental engineering, Ukraine, e-mail: n.m.marchuk@nuwm.edu.ua, ORCID: 0000-0002-7439-7229

train links trajectories displacement relative to the vehicle trajectory and road train overall traffic lane.

It was established that when entering a turn with slight differences in folding angles of road train links, the steered axles of semi-trailer dolly turn in the direction opposite to the direction of a turn, thereby reducing the overall traffic lane. During circular motion, the overall traffic lane of road train with steered semi-trailers decreased by almost 2 m, but such road train does not meet the maneuverability requirements. The search for ways to improve the maneuverability of three-link road trains should be sought in the designs of three-link road trains.

Keywords: vehicle; road train; semi-trailer; container; maneuverability

1. Introduction

In recent years, development of freight transportation in containers served as a powerful impetus for increasing the vehicles length, especially road trains, which made these lengths, agree with the dimensions of ISO universal containers. The container is the most promising and widespread multimodal means of transport. Container freight transportation by two-links, and in recent years, three-link road trains is the most popular [10]. This is due to the well-known advantages of three-link road trains compared with two-link [16]. Among three-link road trains, 35-meter long road trains with two trailers or semi-trailers capable of transporting three containers may be promising, Figure 1, [13].



Fig. 1. Road train with two trailers

This is explained by the fact that the regulations for road freight transportation, like the traffic rules, tend to change from time to time. So, recently in Denmark they thought about the need to use long road trains on public roads. This innovation is related to the idea of reducing the amount of exhaust gas emissions.

Note that the total weight, dimensions and permissible loads for freight vehicles in Europe are regulated by DIRECTIVE 2002/7/EC, in which the maximum total weight of two-link road train with semi-trailer on pneumatic suspension should not exceed 44 tons. In the case of using three-link road trains, the total mass of the road train increases to 60 tons, and multi-link – to 100 tons [3].

Today, in the constructions of multi-link road trains, two main layout schemes are used, as a rule – trailer (vehicle + n-trailers) and semi-trailer (tractor vehicle + n-semi-trailers). In this case, earlier studies generally concern road trains with both non-controlled and controlled links, which are rotated dynamically by braking the wheels of one side, which significantly complicates their construction. At the same time, using the kinematic control method (steering axles of semi-trailers with dual drive control) it is possible to achieve a significant maneuverability improvement of the road train and its operation throughout the road network, which allow up to 10 tons axle load.

Trailed three-link road trains are considered in the paper [14]. Therefore, it is advisable to consider semi-trailer road trains (type “B-triple”) when transporting three containers.

2. Materials and Methods

The advantages of container transportation are that the transportation of large-sized freight in container is many times cheaper than delivery by other means. It can be used to transport various types of freight, including food, chemicals, equipment, etc. The container protects the goods inside, so it does not require complex and expensive packaging in most cases, and in case of multimodal transportation, transshipment operations take place much faster if the goods are in the container. The container can only be opened at the point of departure/destination and at the customs, making the damage and theft of freight unacceptable [16]. These advantages can only be realized if the design of the container matches the freight being transported. Today, containers from 20 foot, Figure 2a, to 45 foot, Figure 2b, in length are used for freight transportation.

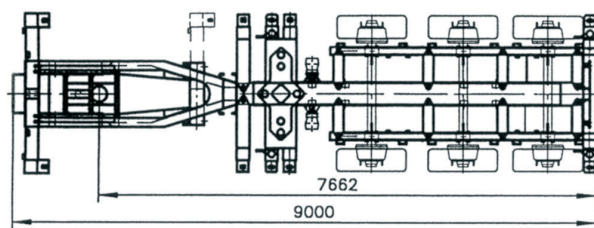

(a)

Fig. 2. Semi-trailer scheme for transporting: a) 20-foot container

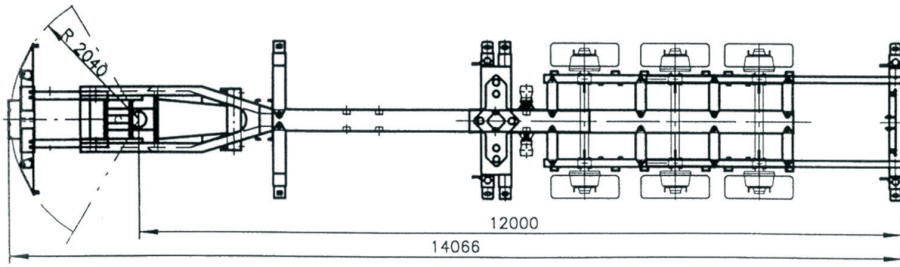

(b)

Fig. 2. Semi-trailer scheme for transporting: b) 45-foot container

Today, both 20-foot and 45-foot containers are transported by two-links road trains as part of tractor vehicle and semi-trailer. The efficiency of such transportation can be increased by means of three-link road trains capable of transporting either three (two 20-foot and one 40- or 45-foot) or four 20-foot containers [7, 11]. This organization of transportation will lead to energy savings and reduction in the level of environmental pollution due to the vehicles reduction. However, at the same time, there is a problem related to the maneuverability and stability of such vehicles [5, 17, 18]. For example, in the paper [2, 6, 8] it was shown that for trailed road trains, the interconnections between individual links can generate a specific oscillating trailers behavior during vehicle maneuvers. This is confirmed by the paper results [1], where it is noted that trailed road trains with a large number of trailers exhibit unstable driving modes at high speeds, including folding links, trailer rolling and rollover. The numerical results obtained for kinematics of three trailers confirm theoretical considerations, giving a certain quantitative view of the problem. Therefore, typical kinematic models of multi-link road trains will be useful in solving the issues of multi-link road trains maneuverability and stability [4, 9, 15].

Compact and easy-to-use mathematical models development will help to solve the problem of reliable traffic forecasts for multi-link vehicles various kinematic designs. In the paper [12], a modular algorithmic approach to the kinematic modeling of road trains with n -trailers is proposed, based on vehicle all wheels pure rolling condition, which is practically justified for low-speed maneuvering conditions. This approach is also realized in the paper [15], where trailed road train links trajectories, hingedly connected to each other, are tracked. Unlike the trailed road train, kinematic model of semi-trailer road trains type "B-double" and "B-triple" is more complex. At the same time, more complex equations to ensure the required maneuverability level can be interpreted as virtual control of wheels placed on semi-trailers, whose rotation angles are determined by non-linear feedback from the original system configuration state [15].

The vehicle maneuverability and stability characteristics, as is known, are determined by a combination of operational, mass-geometric and structural parameters of its modules and their control systems, which, in terms of maneuverability and stability even for the same

vehicle in the range of operating loads and speeds are different [14]. Success in solving such problems depends on how well the mathematical model and its essential parameters describing the dynamic system behavior in different modes of motion are chosen. For maneuverability – it is an equation in plane-parallel motion, taking into account low speeds, for stability – it is a spatial motion. Thus, the complex differential equations of plane-parallel motion are known to determine the maneuverability and stability of two-link semi-trailer and three-link trailed road trains, however, the use of these equations for the comparative evaluation of multi-link container carrier road trains can lead to a significant error. In this regard, the aim of the work is to determine the maneuverability indicators of three-link “B-triple” road trains with steered axles of semi-trailer dollies.

3. Results

For multi-link road train, the overall curvilinear traffic lane in contrast to the straight traffic lane, has a complex shape, limited by trajectories projections on horizontal plane of external, relative to the center of a turn, tractor vehicle side and trailer or semi-trailer rear end. The road train overall traffic lane at the turn is determined by the tractor vehicle main trajectory and trailer or semi-trailer trajectory displacement from the main trajectory to the center of a turn. The overall traffic lane and overall corridor (space part taken by the road train at a turn) reach their maximum on a stable curvilinear, that is, on a circular trajectory. It is on this trajectory that the multi-link road trains overall traffic lane should be determined. In paper [14] it is stated that the road trains maneuverability indicators (at speeds not exceeding 10 m/s) can be determined on wheels rigid in lateral direction, that is, by kinematic models.

Consider three link road train type “B-triple” turn kinematics, Figure 3.

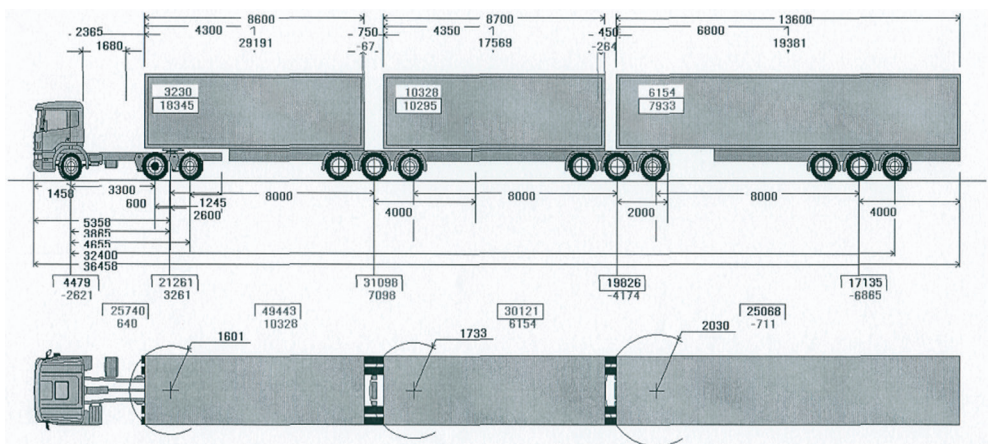

Fig. 3. Three-link road train type “B-triple”

Earlier studies have proved that “B-triple” road trains with non-steered trailed links, as well as with steered trailed links and direct drive control on semi-trailers steered axle, do not meet the regulatory documents requirements.

One possible way of improving such road trains could be to use a dual drive control [14] on steered axles of semi-trailer dollies.

To do this, consider two fundamentally different control systems:

- Scheme №1 – road train with front steered axles of semi-trailer dollies;
- Scheme №2 – road train with rear steered axles of semi-trailer dollies.

Note, however, that three-axle semi-trailer dolly with two rear non-turning axles can always be reduced to a two-axle one, given that the multi-axle dolly turning kinematics is equivalent to a two-axle one. To clarify dual drive control operation, let's first consider two-link road train with two-axle semi-trailer [14].

In case of fixed turn and coincidence of main tractor vehicle (1 – Figure 4) and semi-trailer dolly (2 – Figure 4) trajectories, the dolly pivot axle (3 – Figure 4) shall be turned at an angle θ_1 – Figure 4. The folding angles φ_1 and φ_2 will be used between longitudinal axes of road train links as the setting parameters for dual turn control system of semi-trailer dolly steered axle. Angle θ_1 in this case is a function of the first folding angle [the angle between tractor vehicle and semi-trailer skeleton longitudinal axes] and the second folding angle [the angle between semi-trailer skeleton and its dolly longitudinal axes], i.e., $\theta_1 = f(\varphi_1, \varphi_2)$.

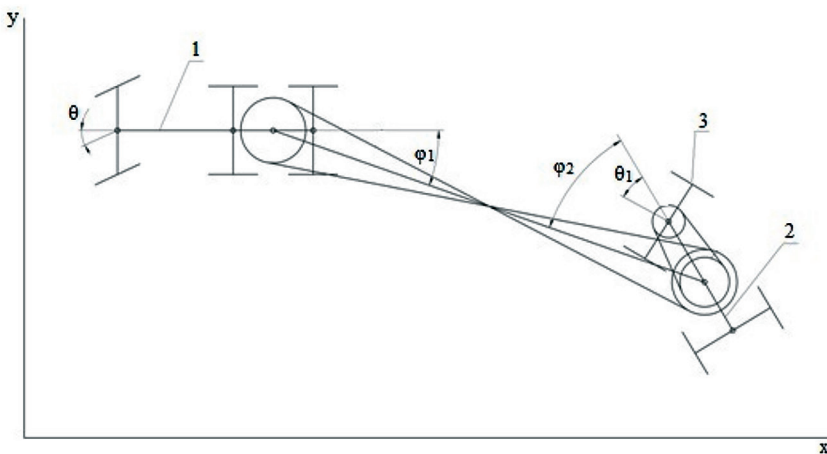

Fig. 4. Road train design scheme with dual drive control on the axle of semi-trailer dolly

When the road train is on input transition path, reduced rotation angle θ of tractor steered wheels is increased by values $\Delta\theta$. At the same time, the rotation angle of semi-trailer steered axle will increase by $\Delta\theta_1$ due to operation of dual control system and increasing of folding angles by values φ_1 and φ_2 , respectively. This process can be represented in the form [14]:

$$(\theta + \Delta\theta) \subset (\varphi_1 + \Delta\varphi_1) \subset (\theta_1 - \Delta\theta_{1\varphi}) \subset (\varphi_2 + \Delta\varphi_2) \subset [(\theta_1 - \Delta\theta_{1\varphi}) + \Delta\theta_{1\varphi_2}] \quad (1)$$

When the road train is on input transition path, we have:

$$(\theta - \Delta\theta) \subset (\varphi_1 - \Delta\varphi_1) \subset (\theta_1 + \Delta\theta_{1\varphi}) \subset (\varphi_2 - \Delta\varphi_2) \subset [(\theta_1 + \Delta\theta_{1\varphi}) - \Delta\theta_{1\varphi_2}] \quad (2)$$

As it follows from [1] and [2], the change in semi-trailer dolly trajectory is realized beyond the impact of direct and backward control communication, that is:

$$\Delta\theta_{1\varphi_1} = \frac{\Delta\varphi_1}{k_{\varphi_1}} \quad (3)$$

$$\Delta\theta_{1\varphi_2} = \frac{\Delta\varphi_2}{k_{\varphi_2}} \quad (4)$$

Where:

k_{φ_1} – proportionality factor for dual drive control system, which displays the rotation of semi-trailer axle as a function of road train first folding angle φ_1 [the first transmission ratio of dual control system];

k_{φ_2} – the same, as a function of road train second folding angle φ_2 [the second transmission ratio of dual control system].

Taking into account [3] and [4], expressions [1] and [2] for rotation angle of semi-trailer steered axle can be represented as:

$$\theta_{11} = u_2\varphi_2 - u_1\varphi_1 \quad (5)$$

Where:

u_1, u_2 – transmission ratios for direct and reverse control communication, which determine dual drive control transmission ratio of semi-trailer axle.

Previous studies [14] proved that the maneuverability of three-link road train type “B-double” is mainly determined by the second semi-trailer trajectories displacements relative to the tractor trajectory. It can be predicted that maneuverability will be determined by the third semi-trailer trajectory displacement according to the vehicle trajectory for “B-triple” road train as well. In this case, when determining the folding angles of three-link “B-triple” road train, we will consider successively the systems consisting of tractor vehicle and first semi-

trailer, first semi-trailer with the second semi-trailer, and then the second and third semi-trailers, Figure 5.

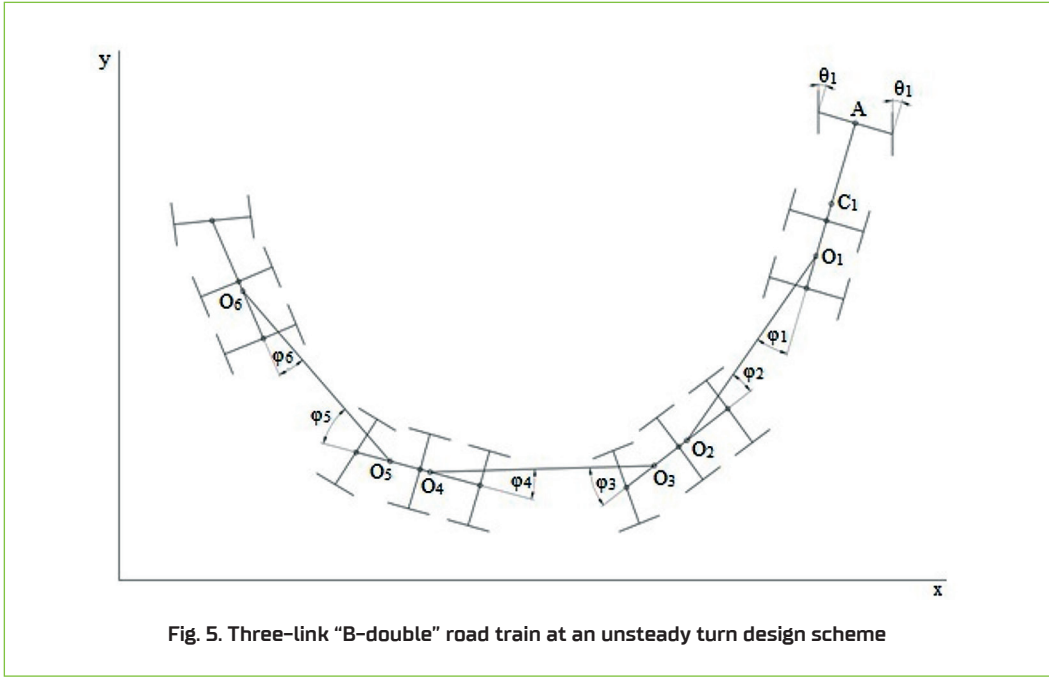

Fig. 5. Three-link “B-double” road train at an unsteady turn design scheme

Taking into account the dependences known from the kinematics, as well as the results of the paper [14], we will get the equations that determine folding angles of the road train links:

$$\frac{d\varphi_1}{dt} + \frac{V_A}{L_1 \frac{\sin\beta_3}{\sin\beta_2}} - \frac{V_{C1} \operatorname{tg}\theta}{a+b-d} = 0 \tag{6}$$

$$\frac{d\varphi_2}{dt} - \frac{V_{C1} \sin\beta_1}{\frac{a_1+b_1}{\operatorname{tg}\theta_1} \sin\beta_3 \times \sqrt{1 + \left(\frac{d_1-c_1}{a_1+b_1} \operatorname{tg}\theta_1\right)^2}} - \frac{V_A \sin\beta_2}{L_1 \sin\beta_1} = 0 \tag{7}$$

$$\frac{d\varphi_3}{dt} - \frac{V_{C1} l_1 \sin\beta_9}{L_1 L_2 \sin\beta_4} - \frac{V_{C1} \sin\beta_2 \times l_1^2 \sin\beta_7}{L_1^2 L_2 \sin\varphi_2 \sin\beta_8} \times \frac{l_1 \sin\beta_3 \operatorname{ctg}\gamma_1}{\frac{a_1+b_1}{\operatorname{tg}\theta_1} \times \sqrt{1 + \left(\frac{d_1-c_1}{a_1+b_1} \operatorname{tg}\theta_1\right)^2} + \frac{L_1 \cos\varphi_1}{L_2 \sin\beta_2} \cdot \frac{l_1}{L_2} \sin\beta_3 \operatorname{ctg}\gamma_1} = 0 \tag{8}$$

$$\frac{d\varphi_4}{dt} - \frac{V_{C2} l_2 \operatorname{ctg}\gamma_1 \sin\beta_2}{L_3 \frac{a_2+b_2}{\operatorname{tg}\theta_2} \sin\beta_6 \times \sqrt{1 + \left(\frac{d_2-c_2}{a_2+b_2} \operatorname{tg}\theta_2\right)^2}} - \frac{l_2 V_{C2} \sin\beta_2 \sin\beta_7}{L_1 L_2 \sin\varphi_2 \sin\beta_8} = 0 \tag{9}$$

$$\frac{d\varphi_5}{dt} - \frac{V_{C3} l_3 \sin\beta_9}{L_2 L_3 \sin\beta_{12}} - \frac{V_{C3} \sin\beta_{13} \times l_3^2 \sin\beta_{14}}{L_2 L_3 \sin\varphi_2 \sin\beta_8} \times \frac{L_3 \sin\beta_3 \operatorname{ctg}\gamma_1}{\frac{a_3+b_3}{\operatorname{tg}\theta_3} \times \sqrt{1 + \left(\frac{d_3-c_3}{a_3+b_3} \operatorname{tg}\theta_3\right)^2} + \frac{L_2 \cos\varphi_5}{L_3 \sin\beta_{11}} \cdot \frac{l_1}{L_3} \sin\beta_{12} \operatorname{ctg}\gamma_1} = 0 \tag{10}$$

$$\frac{d\varphi_6}{dt} - \frac{V_{C3} l_3 \operatorname{ctg}\gamma_2 \sin\beta_{13}}{L_3 \frac{a_2+b_2}{\operatorname{tg}\theta_2} \sin\beta_{12} \times \sqrt{1 + \left(\frac{d_3-c_3}{a_3+b_3} \operatorname{tg}\theta_3\right)^2}} - \frac{l_2 V_{C2} \sin\beta_{13} \sin\beta_{14}}{L_2 L_3 \sin\varphi_5 \sin\beta_{12}} = 0 \tag{11}$$

Where: $\beta_1 = (\pi/2 - \varphi_1 - \alpha_1)$; $\beta_2 = (\varphi_1 + \varphi_2 + \alpha_1)$; $\beta_3 = (\pi/2 - \varphi_2 - \alpha_1)$; $\beta_4 = (\pi/2 - \varphi_2 - \alpha_2)$; $\beta_5 = \sin(\pi/2 - \varphi_4 - \alpha_2)$; $\beta_6 = (\pi/2 - \varphi_3 - \alpha_2)$; $\beta_7 = (\gamma_1 + \varphi_4 + \alpha_2)$; $\beta_8 = (\pi/2 - \varphi_4 - \alpha_2)$; $\beta_9 = (\varphi_1 + \varphi_2 + \alpha_2)$; $\beta_{10} = (\varphi_4 + \varphi_3 + \alpha_2)$; $\beta_{11} = (\varphi_5 + \varphi_4 + \alpha_3)$; $\beta_{12} = (\pi/2 - \varphi_5 - \alpha_3)$; $\beta_{13} = (\varphi_4 + \varphi_5 + \alpha_3)$; $\beta_{14} = (\gamma_2 + \varphi_4 + \alpha_3)$;

$$\alpha_1 = \arctg\left(\frac{d_1 - c_1}{a_1 + b_1} \operatorname{tg}\theta_1\right); \alpha_2 = \arctg\left(\frac{d_2 - c_2}{a_2 + b_2} \operatorname{tg}\theta_2\right); \alpha_3 = \arctg\left(\frac{d_3 - c_3}{a_3 + b_3} \operatorname{tg}\theta_3\right);$$

$$\gamma_1 = \arctg\left[\frac{l_1 \sin\beta_{13}}{L_1 \sin\beta_{12}} \times \frac{1}{\sqrt{1 - \left(\frac{\left(\frac{\sin\beta_{12}}{\sin\beta_{13}} \right)^2 + 1 - \left(\frac{\sin\beta_6}{\sin\beta_{14}} \right)^2 \right)^2}}}{2 \times \frac{\sin\beta_{12}}{\sin\beta_{14}}} \right] \quad (12)$$

$$\gamma_2 = \arctg\left[\frac{l_2 \sin\beta_{13}}{L_2 \sin\beta_{12}} \times \frac{1}{\sqrt{1 - \left(\frac{\left(\frac{\sin\beta_{12}}{\sin\beta_{13}} \right)^2 + 1 - \left(\frac{\sin\beta_{12}}{\sin\beta_{14}} \right)^2 \right)^2}}}{2 \times \frac{\sin\beta_{12}}{\sin\beta_{14}}} \right] \quad (13)$$

The expressions [6-13] are as follows, Figure 5:

L_i – distance from the coupling point of semi-trailer to the point midway between the second and third axles of the dolly, $i = 1, 2, 3$;

L_j – distance from the coupling point of semi-trailer to the point midway between the first and second axles of the dolly, $j = 1, 2, 3$;

a, b – distance from the tractor vehicle center of mass to the front and rear axles, respectively;

c_0 – distance from the vehicle center of mass to the coupling point with first semi-trailer;

c_1 – distance from the first semi-trailer center of mass to the coupling point with the vehicle;

c_2 – distance from the second semi-trailer center of mass to the coupling point with the first semi-trailer;

c_3 – distance from the third semi-trailer center of mass to the coupling point with the second semi-trailer;

l_1, l_2, l_3 – distance between extreme axles of the first, second and third semi-trailer dolly;

$a_{1,2,3}; b_{1,2,3}$ – distance from the first, second and third semi-trailer dolly center of mass to the front and middle of the two rear axles, respectively;

d_1, d_2, d_3 – distance from the center of the first, second and third semi-trailer to the point located in the middle between the second and third axles of the dolly, respectively;

φ_i ($i = 1-6$) – folding angles of the road train links;

$\theta, \theta_1, \theta_2, \theta_3$ – rotation angle of the tractor steered wheels and steered axles of the first, second and third semi-trailer.

Folding angles of road train links and rotation of steered axles, which determine dual drive control transmission ratios, should be determined during the road train circular motion. In this case, calculation formulas for determining folding angles and rotation angles of semi-trailers steered axles are determined by the links geometric parameters and defining parameter – the rotation angle of corresponding link. Table 1 indicate the dependencies for determining folding angles and rotation angles of semi-trailers steered axles with both front and rear axle drive.

Tab. 1. Folding angles and turning angles of semi-trailers steered axles

Drive on front axle of semi-trailer dolly	Drive on rear axle of semi-trailer dolly
$\varphi_1 = \arcsin \frac{L_1^2 + c_0^2 - b^2}{2L_1 \times \sqrt{L_1^2 \text{ctg}^2 \theta + c_0^2}} - \text{arctg} \frac{c_0}{L_1 \text{ctg} \theta}$	$\varphi_1 = \arcsin \frac{L_1^2 + c_0^2 - b^2}{2L_1 \times \sqrt{L_1^2 \text{ctg}^2 \theta + c_0^2}} - \text{arctg} \frac{c_0}{L_1 \text{ctg} \theta}$
$\varphi_2 = \arcsin \frac{L_1^2 - c_0^2 + b^2}{2L_1 \times \sqrt{L_1^2 \text{ctg}^2 \theta + b^2}} + \text{arctg} \frac{b}{L_1 \text{ctg} \theta}$	$\varphi_2 = \arcsin \frac{L_1^2 - c_0^2 + a^2}{2L_1 \times \sqrt{L_1^2 \text{ctg}^2 \theta + a^2}} - \text{arctg} \frac{a}{L_1 \text{ctg} \theta}$
$\varphi_3 = \arcsin \frac{L_2^2 + c_1^2 - b_1^2}{2L_2 \times \sqrt{L_2^2 \text{ctg}^2 \theta_1 + c_1^2}} - \text{arctg} \frac{c_1}{L_2 \text{ctg} \theta_1}$	$\varphi_3 = \arcsin \frac{L_2^2 + c_0^2 - a_1^2}{2L_1 \times \sqrt{L_1^2 \text{ctg}^2 \theta_1 + c_1^2}} - \text{arctg} \frac{c_1}{L_2 \text{ctg} \theta_1}$
$\varphi_4 = \arcsin \frac{L_2^2 - c_1^2 + b_2^2}{2L_2 \times \sqrt{L_2^2 \text{ctg}^2 \theta_2 + b_1^2}} + \text{arctg} \frac{b_2}{L_2 \text{ctg} \theta_2}$	$\varphi_4 = \arcsin \frac{L_2^2 - c_1^2 + a_1^2}{2L_2 \times \sqrt{L_2^2 \text{ctg}^2 \theta_1 + a_1^2}} - \text{arctg} \frac{a_2}{L_2 \text{ctg} \theta_2}$
$\varphi_5 = \arcsin \frac{L_3^2 - c_3^2 + b_3^2}{2L_3 \times \sqrt{L_3^2 \text{ctg}^2 \theta_2 + c_3^2}} - \text{arctg} \frac{c_3}{L_2 \text{ctg} \theta_2}$	$\varphi_5 = \arcsin \frac{L_3^2 + c_3^2 - a_3^2}{2L_1 \times \sqrt{L_2^2 \text{ctg}^2 \theta_2 + c_3^2}} - \text{arctg} \frac{c_3}{L_2 \text{ctg} \theta_2}$
$\varphi_6 = \arcsin \frac{L_3^2 - c_2^2 + b_2^2}{2L_3 \times \sqrt{L_3^2 \text{ctg}^2 \theta_3 + b_3^2}} + \text{arctg} \frac{b_3}{L_2 \text{ctg} \theta_2}$	$\varphi_6 = \arcsin \frac{L_2^2 - c_1^2 + a_1^2}{2L_3 \times \sqrt{L_3^2 \text{ctg}^2 \theta_3 + a_3^2}} - \text{arctg} \frac{b_3}{L_2 \text{ctg} \theta_2}$
$\theta_i = \text{arctg} \frac{L_i}{L_1 \text{ctg} \theta}$	$\theta_j = \text{arctg} \frac{L_j}{L_1 \text{ctg} \theta}$

Folding angles of road train links and rotation of semi-trailers steered axles make it possible to determine the transmission ratios of dual drive control system. Usually, the first drive control transmission ratio is chosen close to unity. Then the second transmission ratio of rear axle drive control of the first, second and third semi-trailers will be determined as:

$$u_1 = \frac{\theta_1 + \varphi_2}{\varphi_3} \tag{14}$$

$$u_2 = \frac{\theta_2 + \varphi_3}{\varphi_4} \tag{15}$$

$$u_3 = \frac{\theta_3 + \varphi_4}{\varphi_5} \tag{16}$$

Considering the fact that drive control transmission ratio depends on folding angles of road train links and rotation angle of semi-trailer steered axle, in Figure 6, as an example, the dependence on folding angles of road train links $\varphi_1, \varphi_2, \varphi_3, \varphi_4, \varphi_5, \varphi_6$ on rotation angle of the tractor vehicle steered wheels during road train circular motion is given.

From the above correlation, Figure 6, it follows that as rotation angle of the tractor steered wheels increases, all folding angles of road train increase, but the largest change occurs for the third [folding angle between the first and second semi-trailer] and fifth [folding angle between the second and third semi-trailer] folding angles. The folding angles, in turn, determine drive control transmission ratio, Figure 7. A characteristic property of dual drive control is that the transmission ratio does not remain constant, but changes with the change of the corresponding road train folding angle.

The folding angles and drive control transmission ratio determine the magnitude and direction of rotation angle by steered axles (wheels) of semi-trailer dolly. From equations [14-16], we determine the rotation angles of semi-trailers dollies steered axles. We get:

$$\theta_1 = u_1\varphi_3 - \varphi_2 \tag{17}$$

$$\theta_2 = u_2\varphi_4 - \varphi_3 \tag{18}$$

$$\theta_3 = u_3\varphi_5 - \varphi_4 \tag{19}$$

When entering a turn at insignificant all folding angles, for steered axles of semi-trailers dollies there is a negative rotation angle value [turn in the direction opposite to the rotation angle of tractor vehicle steering wheels]. With the further folding angles increase, the rotation angles direction for steering axles of semi-trailer dollies will coincide with the tractor vehicle steering wheels rotation direction, which will lead to a reduction in semi-trailer trajectories displacement and road train overall traffic lane.

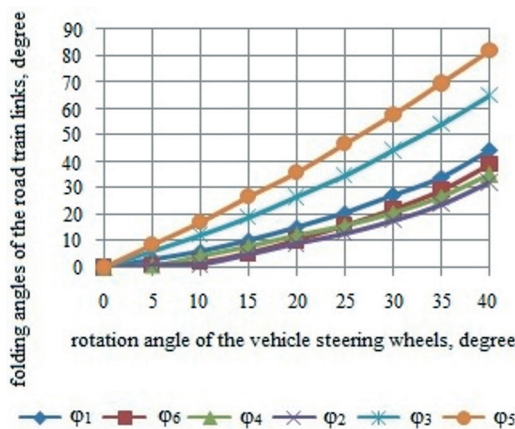

Fig. 6. Dependence of road train links folding angles on rotation angle of tractor-vehicle steering wheels

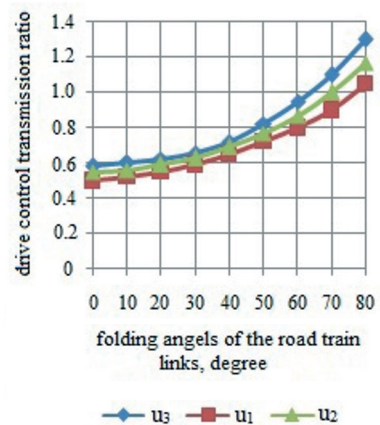

Fig. 7. Dependence of drive control transmission ratio of the second and the third semi-trailer from rotation angle of tractor-vehicle steering wheels

According to the defined folding angles of road train links and drive control transmission ratios, and accordingly, the rotation angles of semi-trailers steering axles (rear steered axles are adopted, which provide smaller overall traffic lane and trajectories displacements in comparison with the front steered axles [14]), the links trajectories displacements were determined, Figure 8a, and the road train overall traffic lane, Figure 8b for the same initial data as for the non-steered semi-trailers shown in Figure 1. At the same time, it was considered that the tractor vehicle enters a turn and continues to move along a circular trajectory with an external overall turning radius $R_{ed} = 12.5$ m, and the trailed links along transition trajectories.

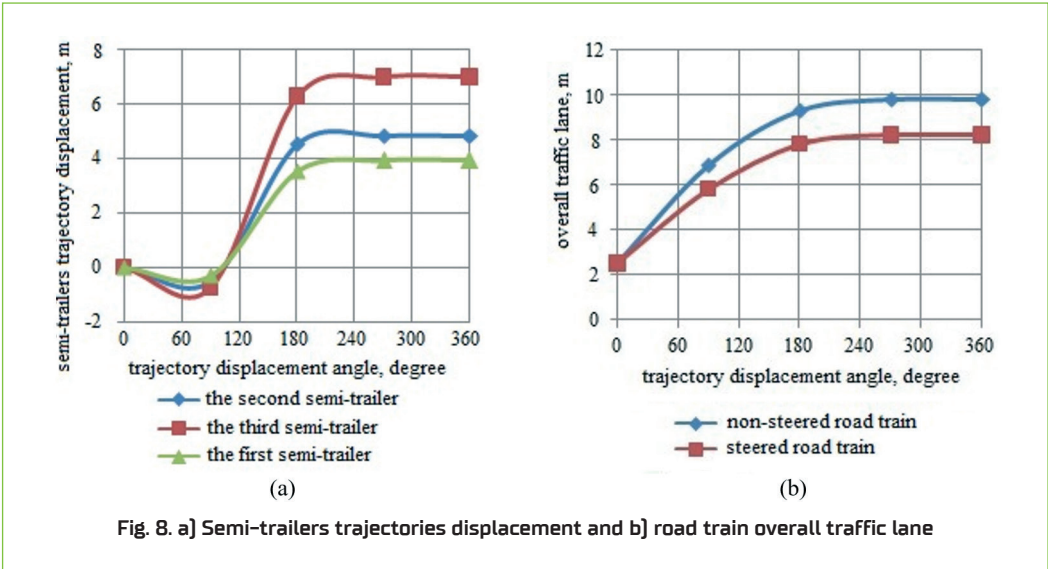

Fig. 8. a) Semi-trailers trajectories displacement and b) road train overall traffic lane

As follows from Figure 8a, all semi-trailers moved in the opposite direction relative to the tractor-vehicle trajectory as they entered the turn. This is explained by dual drive control operation. With slight differences at the beginning of the movement in road train folding angles with drive control transmission ratio of semi-trailers steering axle of a smaller unit, the rotation angles of steering axles $\theta_1, \theta_2, \theta_3$, acquire a negative value, i.e. semi-trailers steering axles turn in the direction opposite to the direction of a turn, thereby reducing the overall traffic lane. Despite the fact that the road train overall traffic lane with steered semi-trailers has decreased by almost 2 m, such road train does not meet the maneuverability requirements of DIRECTIVE 2002/7/EC.

4. Discussion

In order to increase the efficiency of road transportation, reduce fuel consumption and exhaust gas toxicity per unit of carried freight, it is rational to increase the vehicle length, especially of road container trains. Among three-link road trains, 35-meter road trains with two trailers or semi-trailers capable of carrying three containers may be promising.

Today, in the constructions of multi-link road trains, two main layout schemes are used, as a rule – trailed (vehicle + n-trailers) and semi-trailed (tractor-vehicle + n-semi-trailers). In contrast to the trailed three-link road trains, maneuverability studies of three-link “B-triple” road trains are much less, especially for road trains with steered semi-trailers. This led to such a study.

As shown by earlier studies, kinematic models can be used at the preliminary stage of determining road trains maneuverability indicators (at the same time, the error in determining maneuverability indicators based on the kinematic and dynamic model does not exceed 12%). This model is based on the determination of road train links folding angles and drive control transmission ratios of semi-trailer dolly, in the form of a dual drive control. For this drive, rotation angle of a dolly steering axle is defined as a function of the previous (direct control connection) and the following (reverse control connection) road train folding angles. Thus, when entering a turn with slight differences in folding angles of road train links, the rotation angles of steering axles acquire a negative value, that is, semi-trailer dollies steered axles turn towards the opposite direction of the turn, thereby reducing the overall traffic lane. Despite the fact that the overall traffic lane of a road train with steered semi-trailers has decreased by almost 2 m, such road train does not meet the maneuverability requirements of DIRECTIVE 2002/7/EC. Therefore, the search for ways to improve the maneuverability of three-link road trains should be sought in the designs of three-link trailed road trains.

5. Conclusions

A kinematic mathematical model of three-link road train type “B-triple” with steered axles (front or rear) of semi-trailers dollies with a dual drive control on these axles has been developed. In terms of road train links folding angles and drive control transmission ratios of the axles of semi-trailers dollies, the road train main maneuverability indicators are determined – road train links trajectories displacement relative to the vehicle trajectory and road train overall traffic lane.

It was established that when entering a turn with slight differences in folding angles of road train links, steered axles of semi-trailer dollies turn in the direction opposite to the direction of a turn, thereby reducing the overall traffic lane. During circular motion, the overall traffic lane of road train with steered semi-trailers decreased by almost 2 m, such road train does

not meet the maneuverability requirements of DIRECTIVE 2002/7/EC [overall traffic lane $B_{\text{otl}} = 8.1 \text{ m} > [B_{\text{otl}} = 7.2 \text{ m}]$].

6. References

- [1] Altafani C. Some properties of the general n-trailer. *International Journal of Control*. 2001;74(4): 409–424. <https://doi.org/10.1080/00207170010010579>
- [2] De Bernardis M, Rini G, Bottiglione F, Hartavi AE, Sorniotti A. On non linear model predictive direct yaw moment control for trailers way mitigation. *Vehicle System Dynamics*. 2023;61(2):445–471. <https://doi.org/10.1080/00423114.2022.2054352>
- [3] DIRECTIVE 2002/7/EC of European parliament and of the council of 18 February 2002 amending Council Directive 96/53/EC of 25 July 1996 laying down for certain road vehicles circulating within the Community the maximum authorized dimension national and international traffic and the maximum authorized weights international traffic. *Official Journal of the European Communities*. 2002, L67, 0047–0049. Available from: <https://eur-lex.europa.eu/eli/dir/2002/7/oj> [accessed on 09.03.2002]
- [4] Gonzalez D, Perez J, Milanes V, Nashashibi F. A review of motion planning techniques for automated vehicles. *IEEE Transactions on Intelligent Transportation Systems*. 2016;17(4):1135–1145. <https://doi.org/10.1109/TITS.2015.2498841>
- [5] Gottmann F, Wind H, Sawodny D. On the influence of rear axles steering and modeling depth on a model based racing line generation for autonomous racing. *IEEE Conference on Control Technology and Applications*. 2018:846–852. <https://doi.org/10.1109/CCTA.2018.8511508>
- [6] Korayem AH, Khajepour A, Fidan B. A Review on vehicle–trailer state and parameter estimation. *IEEE Transactions on Intelligent Transportation Systems*. 2022;23(7):5993–6010. <https://doi.org/10.1109/TITS.2021.3074457>
- [7] Leduc G. Longer and heavier vehicles. An overview of technical aspects. JRC and Institute for Prospective Technological Studies. European Communities. 2009. <https://doi.org/10.2790/12649>
- [8] Lei T, Gu X, Zhang K, Li X, Wang J. PSO-based variable parameter linear quadratic regulator for articulated vehicles snaking oscillation yaw motion control. *Actuators*. 2022;11(11):337. <https://doi.org/10.3390/act11110337>
- [9] Ljungqvist O, Evestedt N, Axehill D, Cirillo M, Pettersson H. A path planning and path-following control framework for a general 2-trailer with a car-like tractor. *Journal of Field Robotics*. 2019;36(8):1345–1377. <https://doi.org/10.1002/rob.21908>
- [10] Lovska A, Gerlici J, Dižo J, Kravchenko O. Analysis of the strength of a hopper-type container when transported by a semi-trailer. *Transport&Logistics: The International Journal*. 2023;23(55):1–12. Available from: https://www.researchgate.net/publication/376480999_Analysis_of_the_Strength_of_a_Hopper-Type_Container_when_Transported_by_a_Semi-Trailer [accessed on 11.12.2023]
- [11] Md Manjurul I. Parallel design optimization of multi-trailer articulated heavy vehicles with active safety systems. Faculty of Engineering and Applied Science University of Ontario Institute of Technology Oshawa, Ontario, Canada. 2013. Available from: <https://hdl.handle.net/10155/309> [accessed on 01.04.2013]
- [12] Michatek MM. Modular tracking controller for N-trailers with non-zero hitching offsets. *American Control Conference*. 2015:5371–5376. <https://doi.org/10.1109/ACC.2015.7172179>
- [13] Назарук М. У Європі з'являться 35-метрові фури з трьома причепами. 2023, [in Ukrainian: Nazaruk M. 35-meter trucks with three trailers will appear in Europe]. Available from: <https://auto.bigmir.net/ua/autonews/autoworld/7328594-v-evrope-poyavyatsya-35-metrovye-fury-s-tremya-pritsepami> [accessed on 25.09.2023]

- [14] Поляков ВМ, Сахно ВП. Триланкові автопоїзди. Маневреність. Київ, Національний транспортний університет. 2013. [in Ukrainian: Polyakov VM, Sakhno VP. Three-link road trains. Maneuverability. Kyiv]
- [15] Tian X, He R, Sun X, Cai Y, Xu Y. An ANFIS-based ECMS for energy optimization of parallel hybrid electric bus. *IEEE Transactions on Vehicular Technology*. 2020;69(2):1473–1483. <https://doi.org/10.1109/TVT.2019.2960593>
- [16] Топалиди ВА. Модульные большегрузные автопоезда. Проблемы внедрения на международных перевозках. *Вестник ХНАДУ*. 2016;75:190–194. [in Russian: Topalidi VA. Modular heavy road trains. Problems of implementation in international transportation. Kharkiv]
- [17] Wang W, Li G, Liu S. Research on trajectory tracking control of a semi-trailer train based on differential braking. *World Electric Vehicle Journal*. 2024;15(1):30. <https://doi.org/10.3390/wevj15010030>
- [18] Yue M, Hou X, Gao R, Chen J. Trajectory tracking control for tractor-trailer vehicles: a coordinated control approach. *Nonlinear Dynamics*. 2018;91(2):1061–1074. <https://doi.org/10.1007/s11071-017-3928-9>