

FXLMS with Multiple Error Switching for Active Noise-Cancelling Casings

Krzysztof MAZUR*, Stanisław WRONA, Anna CHRAPONSKA
Jarosław RZEPECKI, Marek PAWELCZYK

*Silesian University of Technology
Institute of Automatic Control*

Akademicka 16, 44-100 Gliwice, Poland

e-mail: {stanislaw.wrona, anna.chraponska, jaroslaw.rzepecki, marek.pawelczyk}@polsl.pl

*Corresponding Author e-mail: krzysztof.jan.mazur@polsl.pl

(received March 30, 2019; accepted September 27, 2019)

Passive noise reduction methods require thick and heavy barriers to be effective for low frequencies and those classical ones are thus not suitable for reduction of low frequency noise generated by devices. Active noise-cancelling casings, where casing walls vibrations are actively controlled, are an interesting alternative that can provide much higher low-frequency noise reduction. Such systems, compared to classical ANC systems, can provide not only local, but also global noise reduction, which is highly expected for most applications. For effective control of casing vibrations a large number of actuators is required. Additionally, a high number of error sensors, usually microphones that measure noise emission from the device, is also required. All actuators have an effect on all error sensors, and the control system must take into account all paths, from each actuator to each error sensor. The Multiple Error FXLMS has very high computational requirements. To reduce it a Switched-Error FXLMS, where only one error signal is used at the given time, have been proposed. This, however, significantly reduces convergence rate. In this paper an algorithm that uses multiple errors at once, but not all, is proposed. The performance of various algorithm variants is compared using simulations with the models obtained from real active-noise cancelling casing.

Keywords: active noise control; adaptive control; active casing.

1. Introduction

Low frequency noise generated by devices is a common problem. The effectiveness of passive noise reduction methods for low frequencies is limited by maximal barrier thickness and weight. Active Noise Control (ANC) methods have no such limitations. The active reduction of sound transmitted through a barrier, usually a thin plate (LENIOWSKA, MAZAN, 2015) or a double panel wall (MORZYŃSKI, SZCZEPAŃSKI, 2018; PIETRZKO, 2009), has been the subject of scientific interest for many years. This approach can be extended to a whole casing (FULLER *et al.*, 1994; MAZUR, PAWELCZYK, 2015a), even for device casings not designed for active control, like washing machine (MAZUR *et al.*, 2019).

A large number of algorithms have been proposed for active noise or vibration control and new algo-

rithms are still proposed (SIBIELAK *et al.*, 2015; LENIOWSKA, 2011). For vibration control, where actuators and sensors are collocated, simple feedback control may be sufficient. Such an algorithm can be successfully implemented using simple analog electronic circuits (CINQUEMANI *et al.*, 2018). ANC applications usually require more complex algorithms due to complex secondary paths. In such applications FXLMS algorithm is very popular. In the simplest example each plate of the multiplate casing can be controlled independently, however, it can lead to problems with control system stability due to coupling between individual plates (MAZUR, PAWELCZYK, 2015b). Even for the casing with heavy, rigid frame the coupling still exists due to interactions with the medium inside the casing (WYRWAL *et al.*, 2017). In case of error microphones outside the casing the acoustic interactions in the air outside the casing are also important. Addi-

tionally, for microphone placements required for higher frequencies (MAZUR *et al.*, 2018b), the number of error microphones is usually larger than the number of plates, and for some microphones multiple plates can have similar contribution. In that case it is not possible to assign each error microphone to a single plate and cross-coupling is even higher. It is then even harder to maintain system stability.

Due to stability problems of independent per-plate control systems, the casing should be controlled as a whole. In case of adaptive feed-forward or IMC control Multiple Error Filtered-x Least Mean Squares (MEFXLMS) algorithm can be used (ELLIOTT *et al.*, 1987). The disadvantage of MEFXLMS algorithm is its high computational complexity, proportional to the number of actuators mounted on the casing multiplied by the number of error signals. Casings developed by the authors have even 21 actuators and 21 error sensors. In such system there are 441 secondary paths. Fortunately, most of operations in such an algorithm can be executed fully in parallel and it is possible to execute it in realtime on a system with sufficient performance using multiple microprocessors, Digital Signal Processors (DSP), Field Programmable Gate Arrays (FPGA), or Graphics Processing Units (GPU) (LORENTE *et al.*, 2014). However, for practical usage lower computational complexity of the algorithm is highly preferred. To reduce computational complexity in this application a Switched-Error Filtered-x Least Mean Squares (SEFXLMS) algorithm has been proposed (MAZUR, PAWELCZYK, 2015b; MAZUR *et al.*, 2018a). In the SEFXLMS only one error signal is active at a time, and the active error is periodically switched. The switching period is larger than the secondary path model length. The not needed filtered reference signals are not computed. This further reduces computational demands. Such advantage does not exist if very fast, for instance in each sample, switching is used (MICHALCZYK, WIECZOREK, 2011). The computational demands can be reduced even further by using partial update algorithms (BISMOR, 2014). Then, not only some errors are skipped, but also some control filter parameters are not updated in each step.

Due to switching, the SEFXLMS is slower than MEFXLMS, especially when a large number of error signals is used. For stationary noises the convergence rate is not important. However, if the noise is non-stationary fast convergence rate may be important.

In this paper, an extension to the Switched-Error FXLMS algorithm, the Switched Multiple Error FXLMS (SMEFXLMS) algorithm, is proposed to improve its convergence rate at cost of higher, but still smaller than in MEFXLMS, computational load. Multiple errors are used at once. The performance of various algorithm variants is compared using simulations with the models obtained from real active-noise

cancelling casing: a dedicated lightweight casing and a washing machine.

2. Control algorithm

Figure 1 presents a control system block diagram. The control system reduces noise at N_E error signals, $\mathbf{e}(i)$. Two subsystems contribute to noise: uncontrolled primary paths \mathbf{P} and controlled secondary paths \mathbf{S} . Due to a large number of actuators the control algorithm is explicitly partitioned into P tasks (MAZUR *et al.*, 2018a), each task controls up to C actuators, thus the total number of control signals is $P \times C$.

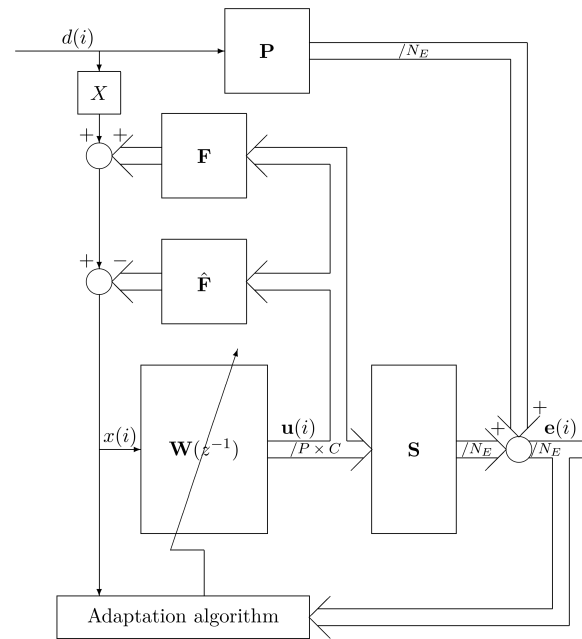

Fig. 1. Control system block diagram.

Linear control filters are used to generate the control signals, c -th control signal on p -th task is calculated according to:

$$u_{p,c}(n+1) = \mathbf{w}_{p,c}(n)^T \mathbf{x}_u(n), \quad (1)$$

where $\mathbf{w}_{p,c}(n) = [w_{p,c,0}(n), w_{p,c,1}(n), \dots, w_{p,c,N_W-1}(n)]^T$ is a vector of control filter weights, $\mathbf{x}_u(n) = [x(n), x(n-1), \dots, x(n-(N_W-1))]^T$ is a vector of the regressors of the reference signal, $x(i)$. For active noise-cancelling casings, where the reference microphone is close to actuators, acoustic feedback compensation (\hat{F}) is usually needed. With acoustic feedback compensation also an error microphone can be used as a reference microphone. This configuration is equivalent to the IMC system (MAZUR, PAWELCZYK, 2016).

3. Adaptation

The key element of the control system is the adaptation of $\mathbf{w}_{p,c}(n)$ control filter weights. In this paper

FXLMS-based algorithm is used. Control filter weights are updated according to:

$$\mathbf{w}_{p,c}(i+1) = \alpha \mathbf{w}_{p,c}(i) - \sum_{j=0}^{N_E-1} \mu_{p,c,j}(i) \mathbf{r}_{p,c,j}(i) e_j(i), \quad (2)$$

where $0 \ll \alpha \leq 1$ is a leakage coefficient, $\mu_{p,c,j}(i)$ is an LMS algorithm step size, $\mathbf{r}_{p,c,j}(i)$ is a vector of regressors of filtered reference signals, $e_j(i)$ is the j -th error signal. For $\alpha = 1$ and $\mu_{p,c,j}(i) = \mu$ classical Multiple Error FXLMS algorithm is obtained (ELLIOTT *et al.*, 1987). In this algorithm the step size μ is extended to a non-stationary matrix with $\mu_{p,c,j}(i)$ coefficients. Most of those coefficients are equal to zero to reduce computational load.

The filtered reference signals are calculated according to:

$$r_{p,c,j}(i) = \widehat{\mathbf{s}}_{p,c,j}(i)^T \mathbf{x}_s(i), \quad (3)$$

where $\mathbf{x}_s(i) = [x(i), x(i-1), \dots, x(i-(N_S-1))]^T$ is a vector of regressors of the reference signal, and $\widehat{\mathbf{s}}_{p,c,j}(i) = [\widehat{s}_{p,c,j,0}(i), \widehat{s}_{p,c,j,1}(i), \dots, \widehat{s}_{p,c,j,N_S-1}(i)]$ is a model of the c -th secondary path for the p -th task to the j -th error microphone. N_S is the length of the FIR filters used to model secondary paths.

In active control, where the noise power is usually not known in advance, variable step-size LMS algorithms are usually used. There are many variable step-size algorithms (BISMOR *et al.*, 2016). In this paper a per-task normalised FXLMS is used (MAZUR, PAWELCZYK, 2015b):

$$\mu_{p,c,j}(i) = (P_p(i) + \zeta)^{-1} q_j(i) \mu_n, \quad (4)$$

where $\mathbf{q}(i) = [q_0(i), q_1(i), \dots, q_{N_E-1}(i)]^T$ is a vector of error enable signals. If the j -th error is enabled in i -th sample then $q_j(i) = 1$; $q_j(i) = 0$ otherwise. For Multiple Error FXLMS $q_j(i) = 1$ for any j . The $P_p(i)$ is the power of reference signals:

$$P_p(i) = \sum_{l=0}^{N_C-1} \sum_{m=0}^{N_E-1} \sum_{o=0}^{N_S-1} (r_{p,l,m}(i-o))^2. \quad (5)$$

Such normalisation, unfortunately, requires all filtered reference signals, even for error signals that are disabled. If those signals are skipped different error signals may use different step size, which is equivalent to using different weight for different error signals. To avoid that in case of proposed SMEFXLMS an exponential weighting is used:

$$P_p(i) = (1 - \beta) P_p(i-1) + \beta \left(\sum_{l=0}^{N_C-1} \sum_{m=0}^{N_E-1} (q_m(i) r_{p,l,m}(i))^2 \right), \quad (6)$$

where $0 < \beta < 1$ is an exponential window parameter. This exponential window roughly approximates

a rectangular window with β^{-1} length. To avoid different step sizes for different errors this length should be larger than the total switching period.

Error signals are sequentially switched in a round-robin fashion:

$$\mathbf{q}(i) = \mathbf{q}_{a(i)}, \quad (7)$$

where $a(i) = \left\lfloor \frac{i}{N_A} \right\rfloor \bmod N_B$, $N_A \geq N_W$ is an error switching period, N_B is a number of different error sets. Different error sets form a switching matrix:

$$\mathbf{Q} = [\mathbf{q}_0, \mathbf{q}_1, \dots, \mathbf{q}_{N_B-1}]. \quad (8)$$

Different columns of the \mathbf{Q} matrix are used sequentially. The sum of elements in each row should be equal and non-zero, otherwise different errors will have uneven impact on adaptation, or even some errors will have no impact on the adaptation. If the noise signal is non-stationary switching may cause uneven impact of different errors on adaptation or even can lead to instability for cyclostationary input signals (BISMOR, 2016). Such problems can be avoided if active column of this matrix is selected randomly, $a(i)$ sequence is random. The order of rows should not affect the performance of the algorithm, assuming that the switching is fast enough. To maximise switching frequency the N_B should be minimal.

Since, usually, the number of active errors is low, a large number of $q_j(i)$ coefficients is equal to zero. If $q_j(i)$ is equal to zero all $\mu_{p,c,j}(i)$ coefficients for the same j are equal to zero. This significantly reduces the number of required computations in the adaptation equation (Eq. (2)). Additionally, the $\mathbf{r}_{p,c,j}(i)$ vector is not needed to update control filter weights because it is multiplied by zero, and to reduce computational load its computation can be skipped. However, the computation of the whole $\mathbf{r}_{p,c,j}(i)$ vector in a single step is costly, and a single $r_{p,c,j}(i)$ coefficient is computed in each iteration (Eq. (3)). Thus, if the full $\mathbf{r}_{p,c,j}(i)$ vector will be required soon in the future, its calculation must start earlier, at least $N_W - 1$ samples earlier. So in each step $\mathbf{r}_{p,c,j}(i)$ must be calculated if: $\exists_{0 \leq k < N_W} \{q_j(i+k) = 1\}$. If $N_A = N_W$, it means that $\mathbf{r}_{p,c,j}(i)$ vector must be calculated for the current active errors, $\mathbf{q}_{a(i)}$, and for the next active errors, $\mathbf{q}_{a(i+N_A-1)}$.

4. Simulation

The convergence rate of the SMEFXLMS algorithm has been tested on models of two active casings: a dedicated lightweight noise-cancelling casing (MAZUR, PAWELCZYK, 2016) with 21 actuators mounted on 5 walls with 5 error microphones, and on a real washing machine (MAZUR *et al.*, 2018b) with 13 actuators mounted on 4 walls with 8 error microphones (Fig. 2). In both cases every electroacoustic path in the control system, from each output (actuators, primary path

loudspeaker) to each input (reference and error microphones), was modelled using 256 parameter FIR model. The parameters of FIR models were obtained during the identification experiment.

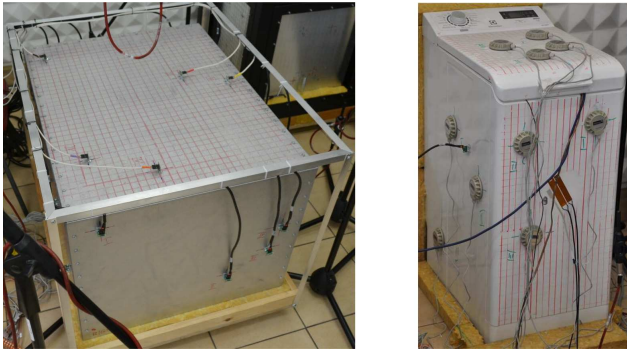

Fig. 2. Dedicated lightweight casing (left) and the real washing machine (right).

In case of the lightweight casing with 5 errors the results for the following cases are presented:

- 1) One active error at once, SEFXLMS:

$$Q_1 = \begin{bmatrix} 1 & 0 & 0 & 0 & 0 \\ 0 & 1 & 0 & 0 & 0 \\ 0 & 0 & 1 & 0 & 0 \\ 0 & 0 & 0 & 1 & 0 \\ 0 & 0 & 0 & 0 & 1 \end{bmatrix}. \quad (9)$$

The Q_1 matrix leads to the switching scheme presented in Fig. 3. One error signal is used for adaptation, and filtered references for two error signals are computed, for the error required for adaptation and also next error.

$\lfloor \frac{i}{N_A} \rfloor$	0	1	2	3	4	5	6	7	8	...
$s(i)$	0	1	2	3	4	0	1	2	3	...
e_0	+	-	-	-	FX	+	-	-	-	...
e_1	FX	+	-	-	-	FX	+	-	-	...
e_2	-	FX	+	-	-	-	FX	+	-	...
e_3	-	-	FX	+	-	-	-	FX	+	...
e_4	-	-	-	FX	+	-	-	-	FX	...

Fig. 3. Error switching scheme for the Switched-Error FXLMS algorithm with single error, variant Q_1 (“+” – enabled error, “FX” – disabled adaptation, enabled filtered-reference; “-” – disabled adaptation).

- 2) Two active errors, but only one error is changed during the switch:

$$Q_{2A} = \begin{bmatrix} 1 & 0 & 0 & 0 & 1 \\ 1 & 1 & 0 & 0 & 0 \\ 0 & 1 & 1 & 0 & 0 \\ 0 & 0 & 1 & 1 & 0 \\ 0 & 0 & 0 & 1 & 1 \end{bmatrix}. \quad (10)$$

The Q_{2A} matrix leads to the switching scheme presented in Fig. 4. Two error signals are used for adaptation, and filtered references for three error signals are computed.

$\lfloor \frac{i}{N_A} \rfloor$	0	1	2	3	4	5	6	7	8	...
$s(i)$	0	1	2	3	4	0	1	2	3	...
e_0	+	-	-	FX	+	+	-	-	-	...
e_1	+	+	-	-	FX	+	+	-	-	...
e_2	FX	+	+	-	-	FX	+	+	-	...
e_3	-	FX	+	+	-	-	FX	+	+	...
e_4	-	-	FX	+	+	-	-	FX	+	...

Fig. 4. Error switching scheme for the SMEFXLMS algorithm with two errors, variant Q_{2A} (“+” – enabled error, “FX” – disabled adaptation, enabled filtered-reference; “-” – disabled adaptation).

- 3) Two active errors, both changed in each step:

$$Q_{2B} = \begin{bmatrix} 1 & 0 & 1 & 0 & 0 \\ 1 & 0 & 0 & 1 & 0 \\ 0 & 1 & 0 & 1 & 0 \\ 0 & 1 & 0 & 0 & 1 \\ 0 & 0 & 1 & 0 & 1 \end{bmatrix} \quad (11)$$

The Q_{2B} matrix leads to the switching scheme presented in Fig. 5. Two error signals are used for adaptation, like for Q_{2A} matrix, but filtered reference signals for one more error signal are computed.

$\lfloor \frac{i}{N_A} \rfloor$	0	1	2	3	4	5	6	7	8	...
$s(i)$	0	1	2	3	4	0	1	2	3	...
e_0	+	FX	+	-	FX	+	FX	+	-	...
e_1	+	-	FX	+	FX	+	-	FX	+	...
e_2	FX	+	FX	+	-	FX	+	FX	+	...
e_3	FX	+	-	FX	+	FX	+	-	FX	...
e_4	-	FX	+	FX	+	-	FX	+	FX	...

Fig. 5. Error switching scheme for the SMEFXLMS algorithm with two errors, variant Q_{2B} (“+” – enabled error, “FX” – disabled adaptation, enabled filtered-reference; “-” – disabled adaptation).

- 4) Three active errors, but only one error is changed during the switch:

$$Q_{3A} = \begin{bmatrix} 1 & 0 & 0 & 1 & 1 \\ 1 & 1 & 0 & 0 & 1 \\ 1 & 1 & 1 & 0 & 0 \\ 0 & 1 & 1 & 1 & 0 \\ 0 & 0 & 1 & 1 & 1 \end{bmatrix}. \quad (12)$$

Figure 6 shows error microphone signals power for 150 Hz tonal primary noise for different control algorithms. The same normalised step size, $\mu_n = 0.005$, is used for all algorithms. The high power variations in SEFXLMS and SMEFXLMS algorithms are observed due to error switching. When the control system tries to minimise a set of errors, noise reduction for other errors slightly drops. In case of slow adaptation, small μ_n , the drops are not noticeable because

very small weights change is performed in each step. The differences in convergence rate are clearly visible at left and right error microphones, SEFXLMS with a single error is clearly the slowest algorithm. In case of two algorithms with two error signals, variant Q_{2B} is clearly better.

Because optimal performance for different algorithms may need different μ_n the time required for adaptation was tested for different μ_n values (Fig. 7).

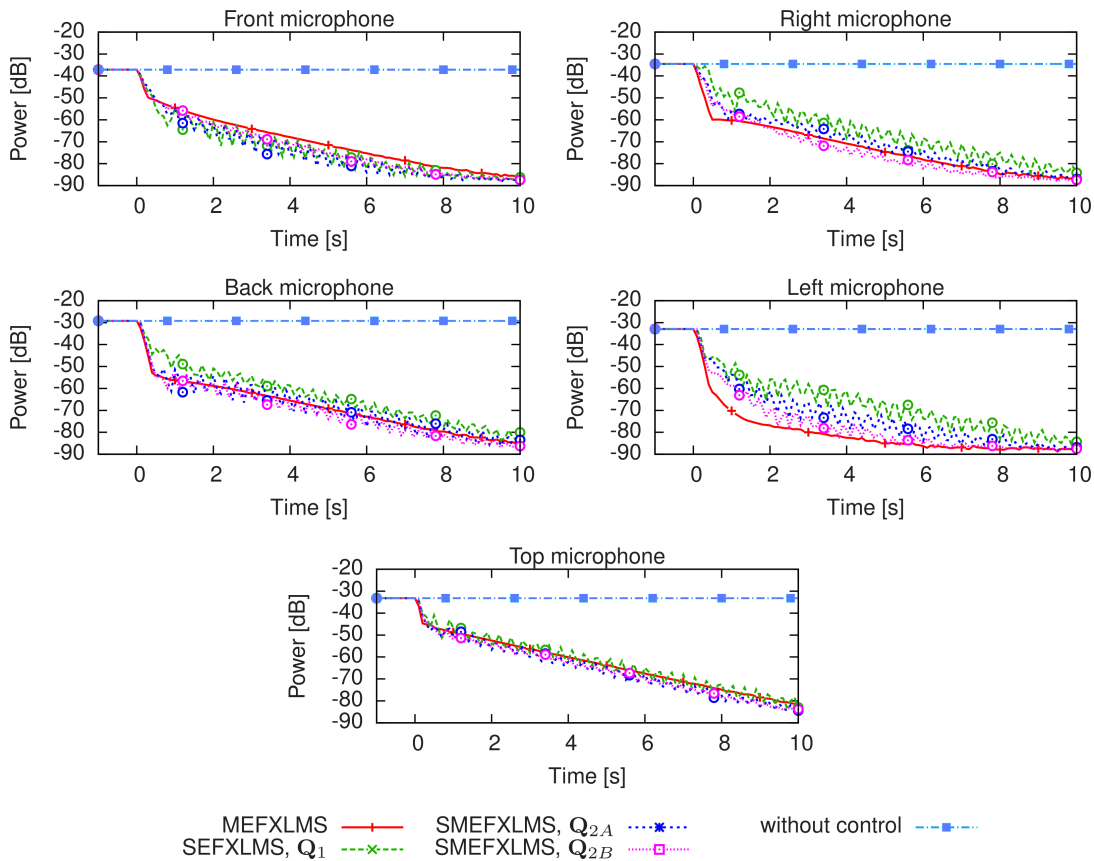

Fig. 6. Error microphone signals power for different control algorithms. At $t = 0$ s, the active control is turned on. Primary noise – 150 Hz tone ($\mu_n = 0.005$, lightweight casing).

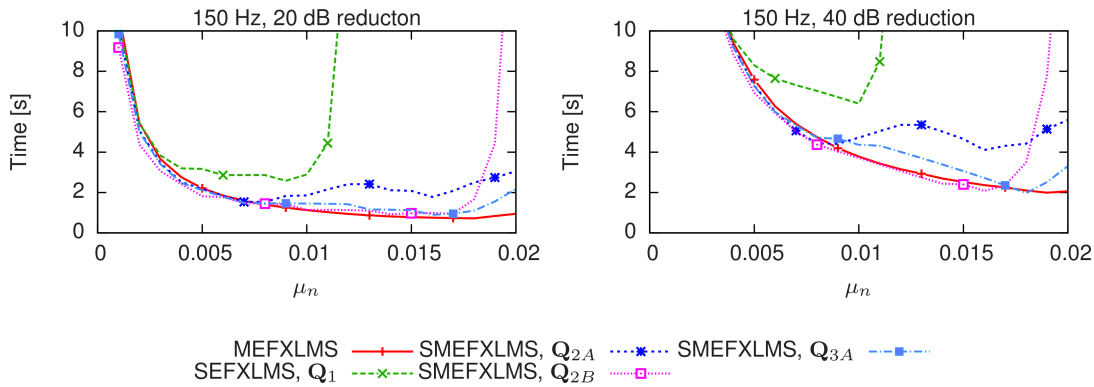

Fig. 7. Time required by different adaptation algorithms to obtain 20 dB or 40 dB noise reduction at *all* error microphones (lightweight casing).

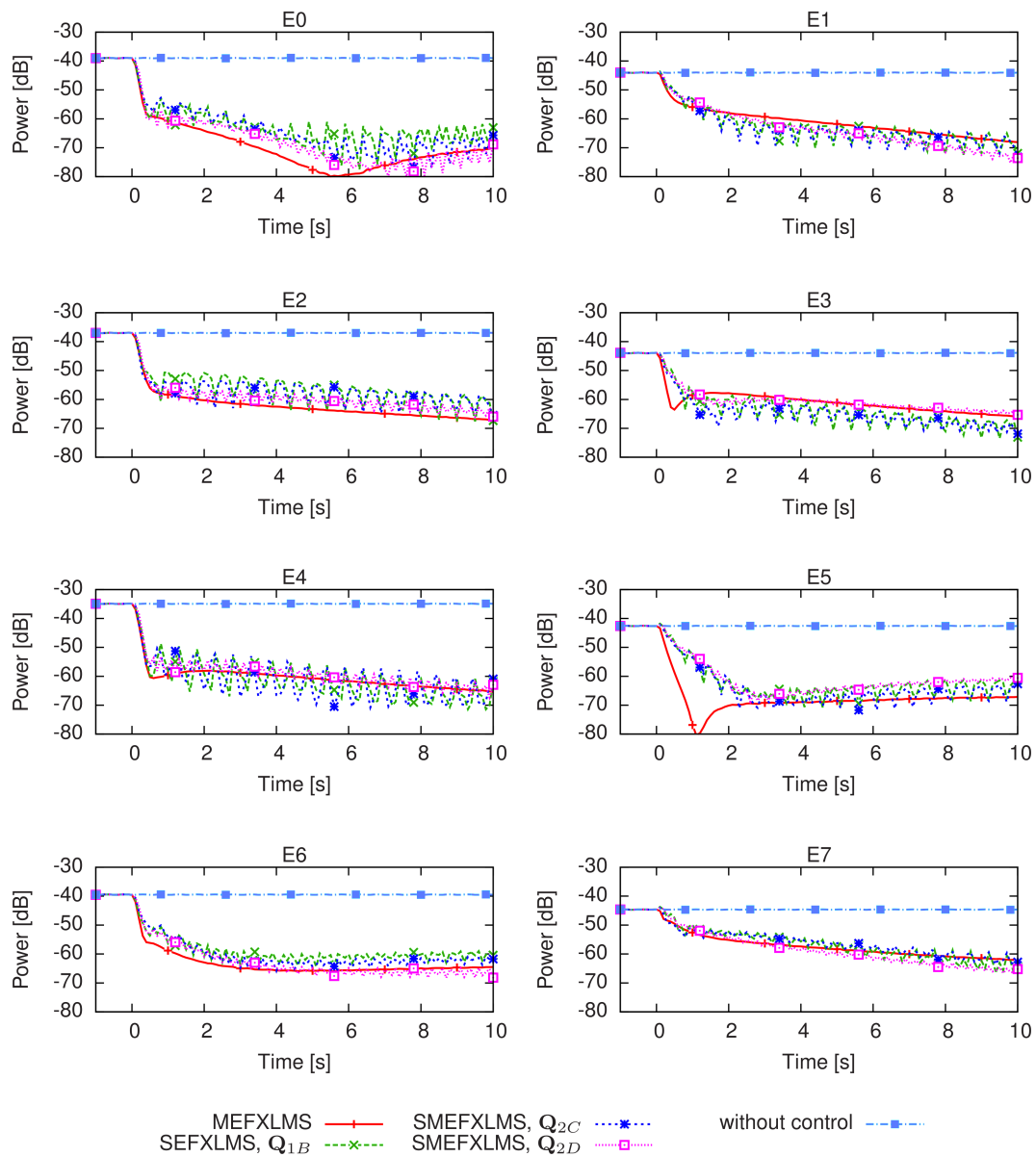

Fig. 8. Error microphone signals power for different control algorithms. At $t = 0$ s, the active control is turned on. Primary noise – 114 Hz tone ($\mu_n = 0.003$, washing machine).

The presented time is a time needed by the adaptation algorithm to obtain at least 20 dB or 40 dB reduction at *all* error microphones. Using multiple errors instead of one significantly decreases the required time. It also allows for higher step size without performance degradation. The performance degradation for higher step sizes is caused by too fast adaptation for selected error/errors at cost of reduction of performance on other errors. The Q_{2B} system in most cases provides better convergence time than the Q_{3A} system.

The second system is a real washing machine, with 4 actively controlled walls and 8 error sensors. Figure 8 shows error microphone signals power for 114 Hz tonal primary noise, the dominating tone dur-

ing 1200 rpm spinning phase, for different control algorithms.

The following cases are presented:

- 1) One active error at once, SEFXLMs:

$$Q_{1B} = \begin{bmatrix} 1 & 0 & 0 & 0 & 0 & 0 & 0 & 0 \\ 0 & 1 & 0 & 0 & 0 & 0 & 0 & 0 \\ 0 & 0 & 1 & 0 & 0 & 0 & 0 & 0 \\ 0 & 0 & 0 & 1 & 0 & 0 & 0 & 0 \\ 0 & 0 & 0 & 0 & 1 & 0 & 0 & 0 \\ 0 & 0 & 0 & 0 & 0 & 1 & 0 & 0 \\ 0 & 0 & 0 & 0 & 0 & 0 & 1 & 0 \\ 0 & 0 & 0 & 0 & 0 & 0 & 0 & 1 \end{bmatrix}. \tag{13}$$

2) Two active errors, but only one error is changed during the switch:

$$\mathbf{Q}_{2C} = \begin{bmatrix} 1 & 0 & 0 & 0 & 0 & 0 & 0 & 1 \\ 1 & 1 & 0 & 0 & 0 & 0 & 0 & 0 \\ 0 & 1 & 1 & 0 & 0 & 0 & 0 & 0 \\ 0 & 0 & 1 & 1 & 0 & 0 & 0 & 0 \\ 0 & 0 & 0 & 1 & 1 & 0 & 0 & 0 \\ 0 & 0 & 0 & 0 & 1 & 1 & 0 & 0 \\ 0 & 0 & 0 & 0 & 0 & 1 & 1 & 0 \\ 0 & 0 & 0 & 0 & 0 & 0 & 1 & 1 \end{bmatrix}. \quad (14)$$

3) Three active errors, but only one error is changed during the switch:

$$\mathbf{Q}_{3C} = \begin{bmatrix} 1 & 0 & 0 & 0 & 0 & 0 & 1 & 1 \\ 1 & 1 & 0 & 0 & 0 & 0 & 0 & 1 \\ 1 & 1 & 1 & 0 & 0 & 0 & 0 & 0 \\ 0 & 1 & 1 & 1 & 0 & 0 & 0 & 0 \\ 0 & 0 & 1 & 1 & 1 & 0 & 0 & 0 \\ 0 & 0 & 0 & 1 & 1 & 1 & 0 & 0 \\ 0 & 0 & 0 & 0 & 1 & 1 & 1 & 0 \\ 0 & 0 & 0 & 0 & 0 & 1 & 1 & 1 \end{bmatrix}. \quad (15)$$

4) Two active errors, both changed in each step:

$$\mathbf{Q}_{2D} = \begin{bmatrix} 1 & 1 & 0 & 0 & 0 & 0 & 0 & 0 \\ 0 & 0 & 1 & 1 & 0 & 0 & 0 & 0 \\ 0 & 0 & 0 & 0 & 1 & 1 & 0 & 0 \\ 0 & 0 & 0 & 0 & 0 & 0 & 1 & 1 \end{bmatrix}^T. \quad (16)$$

5) Four active errors, all 4 changed in each step:

$$\mathbf{Q}_{4D} = \begin{bmatrix} 1 & 1 & 1 & 1 & 0 & 0 & 0 & 0 \\ 0 & 0 & 0 & 0 & 1 & 1 & 1 & 1 \end{bmatrix}^T. \quad (17)$$

Figures 9 and 10 show the time required for adaptation for different μ_n . As for lightweight casing, the \mathbf{Q}_{2B} system in most cases provides better convergence time than the \mathbf{Q}_{3A} system.

5. Conclusions

In this paper a new SMEFXLMS algorithm has been proposed. This algorithm is an extension to the SEFXLMS. The goal of SMEFXLMS is to increase convergence rate compared to SEFXLMS at cost of increased computational load. By using two error signals at once, instead of one, the convergence rate can be increased by more than twice, because not only more errors are used with the same step size, but also a higher step size can be used, at cost of twice the number of operations needed for adaptation. Faster switching allows also for smaller β . In some cases the SMEFXLMS provides even faster adaptation than MEFXLMS. However, such behavior is due to differences in the reference signal power estimation during normalisation. Generally, the SMEFXLMS provides slower adaptation than MEFXLMS, but its computational load is significantly reduced.

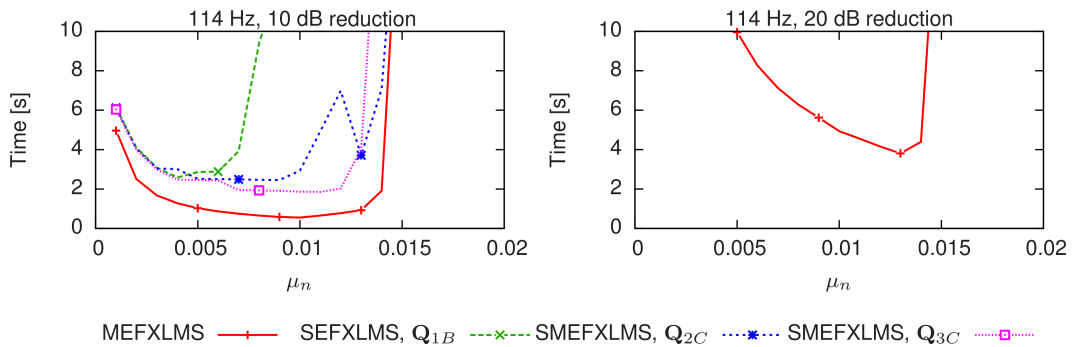

Fig. 9. Time required by different adaptation algorithms to obtain 10 dB or 20 dB noise reduction at *all* error microphones (washing machine).

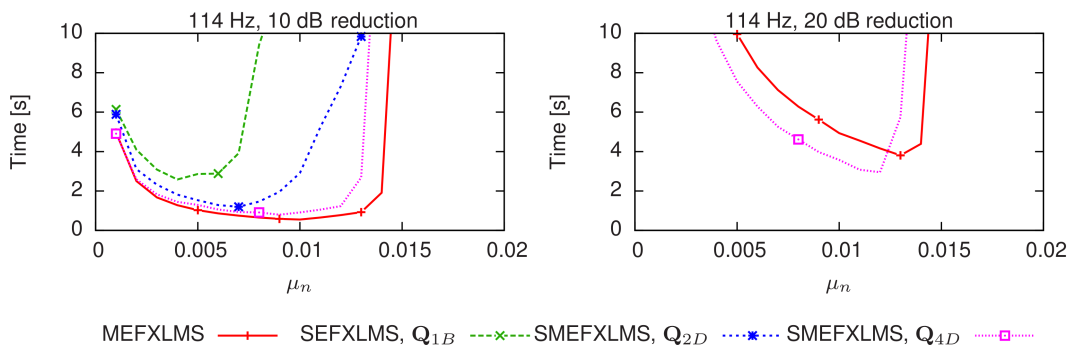

Fig. 10. Time required by different adaptation algorithms to obtain 10 dB or 20 dB noise reduction at *all* error microphones (washing machine).

The SMEFXLMS algorithm can be used, at cost of reduced convergence rate, in many applications where Multiple Error FXLMS algorithm is used. It can be used in applications where noise is stationary or changes in noise signal properties are slower than adaptation speed and switching period. Additionally, for non-stationary signals the switching should be randomised to avoid uneven influence of error signals on adaptation and possible problems with instability.

Acknowledgment

The research reported in this paper has been supported by the National Science Centre, decision no. DEC-2017/25/B/ST7/02236, and by the Ministry of Higher Education and Science.

References

1. BISMOR D. (2014), *Partial update LMS algorithms in active noise control*, [in:] Proceedings of the Forum Acusticum 2014, Kraków.
2. BISMOR D. (2016), *Simulations of partial update LMS algorithms in application to active noise control*, *Procedia Computer Science*, **80**, pp. 1180–1190, International Conference on Computational Science 2016, ICCS 2016, 6–8 June 2016, San Diego, California, USA.
3. BISMOR D., CZYZ K., OGOŃSKI Z. (2016), *Review and comparison of variable step-size LMS algorithms*, *International Journal of Acoustics and Vibration*, **21**, 1, 24–39, doi: 10.20855/ijav.2016.21.1392.
4. CINQUEMANI S., BASSETTI M., RESTA F. (2018), *Design and testing of a mechatronic device to actively self suppress vibration in structures*, *International Journal of Acoustics & Vibration*, **23**, 2, 124–130, doi: 10.20855/ijav.2018.23.21072.
5. ELLIOTT S.E., STOTHERS I.M., NELSON P.A. (1987), *A multiple error LMS algorithm and its application to the active control of sound and vibration*, *IEEE Transactions on Acoustics, Speech and Signal Processing*, **35**, 10, 1423–1434, doi: 10.1109/TASSP.1987.1165044.
6. FULLER C., MCLOUGHLIN M., HILDEBRAND S. (1994), *Active acoustic transmission loss box*, WO Patent App. PCT/US1992/008,401.
7. LENIOWSKA L. (2011), *An adaptive vibration control procedure based on symbolic solution of Diophantine equation*, *Archives of Acoustics*, **36**, 4, 901–912.
8. LENIOWSKA L., MAZAN D. (2015), *MFC sensors and actuators in active vibration control of the circular plate*, *Archives of Acoustics*, **40**, 2, 257–265, doi: 10.1515/aoa-2015-0028.
9. LORENTE J., FERRER M., DE DIEGO M., GONZALEZ A. (2014), *GPU implementation of multichannel adaptive algorithms for local active noise control*, *Audio, Speech, and Language Processing, IEEE/ACM Transactions on*, **22**, 11, 1624–1635, doi: 10.1109/TASLP.2014.2344852.
10. MAZUR K., PAWELCZYK M. (2015a), *Active control of noise emitted from a device casing*, [in:] Proceedings of the 22nd International Congress of Sound and Vibration, Florence, Italy.
11. MAZUR K., PAWELCZYK M. (2015b), *Multiple-error adaptive control of an active noise-reducing casing*, [in:] *Progress of Acoustics*, pp. 701–712, Polish Acoustical Society, Wrocław.
12. MAZUR K., PAWELCZYK M. (2016), *Internal Model Control for a light-weight active noise-reducing casing*, *Archives of Acoustics*, **41**, 2, 315–322, doi: 10.1515/aoa-2016-0032.
13. MAZUR K., WRONA S., PAWELCZYK M. (2018a), *Design and implementation of multichannel global active structural acoustic control for a device casing*, *Mechanical Systems and Signal Processing*, **98**, 877–889, doi: 10.1016/j.ymssp.2017.05.025.
14. MAZUR K., WRONA S., PAWELCZYK M. (2018b), *Placement of microphones for an active noise-reducing casing*, [in:] 25th International Congress on Sound and Vibration, ICSV25, Hiroshima, 8–12 July.
15. MAZUR K., WRONA S., PAWELCZYK M. (2019), *Active noise control for a washing machine*, *Applied Acoustics*, **146**, 89–95, doi: 10.1016/j.apacoust.2018.11.010.
16. MICHALCZYK M., WIECZOREK M. (2011), *Parameterization of adaptive control algorithms for multichannel active noise control system*, [in:] 58th Open Seminar on Acoustics joint with 2nd Polish-German Structured Conference on Acoustics, Jurata, Poland 13–16.09.2011, Vol. 2, pp. 73–78.
17. MORZYŃSKI L., SZCZEPAŃSKI G. (2018), *Double panel structure for active control of noise transmission*, *Archives of Acoustics*, **43**, 4, 689–696, doi: 10.24425/aoa.2018.125162.
18. PIETRZKO S.J. (2009), *Contributions to noise and vibration control technology*, AGH – University of Science and Technology Press, Kraków.
19. SIBIELAK M., RACZKA W., KONIECZNY J., KOWAL J. (2015), *Optimal control based on a modified quadratic performance index for systems disturbed by sinusoidal signals*, *Mechanical Systems and Signal Processing*, **64–65**, 498–519, doi: 10.1016/j.ymssp.2015.03.031.
20. WYRWAL J., ZAWISKI R., PAWELCZYK M., KLAMKA J. (2017), *Modelling of coupled vibro-acoustic interactions in an active casing for the purpose of control*, *Applied Mathematical Modelling*, **50**, 219–236, doi: 10.1016/j.apm.2017.05.002.