

B. KALANDYK^{1*}, R. ZAPAŁA¹, S. SOBULA¹, G. TĘCZA¹, K. PIOTROWSKI²

ASSESSMENT OF MICROSTRUCTURE AND MECHANICAL PROPERTIES OF THE SLAG LADLE AFTER EXPLOITATION

The results of tests and examinations of the microstructure and mechanical properties of cast steel used for large-size slag ladles are presented. Castings of this type (especially large-size ladles with a capacity of up to 16 m³) operate under very demanding conditions resulting from the repeated cycles of filling and emptying the ladle with liquid slag at a temperature exceeding even 1600°C. The changes in operating temperature cause faster degradation and wear of slag ladle castings, mainly due to thermal fatigue.

The tests carried out on samples taken from different parts/areas of the ladle (flange, bottom and half-height) showed significant differences in the microstructure of the flange and bottom part as compared to the microstructure obtained at half-height of the ladle wall. The flange and bottom were characterized by a ferritic-pearlitic microstructure, while the microstructure at the ladle half-height consisted of a ferritic matrix, cementite and graphite precipitates. Changes in microstructure affected the mechanical properties. Based on the test results it was found that both the flange and the bottom of the ladle had higher mechanical properties, i.e. UTS, YS, hardness, and impact energy than the centre of the ladle wall. Fractography showed the mixed character of fractures with the predominance of brittle fracture. Microporosity and clusters of non-metallic inclusions were also found in the fractures of samples characterized by low properties.

Keywords: Slag pots, Cast steel, Mechanical properties, Degradation of microstructure

1. Introduction

The need to reduce waste and the development of recycling technology in the metallurgical and foundry industries allow for economic reuse of slags from the refining processes of steel, copper and aluminium alloys as one of the many components of synthetic slags, backfills used in the metallurgical industry or, due to the high strength and low water absorption rate, as a component applicable in road construction [1-7]. Slags from metallurgical processes are transported in large-volume ladles made of cast iron (e.g. EN GJS400-18) or cast steel (e.g. GS20Mn5 or GS45) [8-10]. These castings operate under very demanding conditions associated with constant temperature changes during operating cycle. The changes are caused by repeated filling and emptying of the ladle with liquid slag whose temperature is ranging from 600 to 1400°C, and rises even up to 1600°C in the case of slag from the LD oxygen converter. Additionally, the walls of the ladle are exposed to the effect of the changing thermal and mechanical load resulting from the

weight of the poured slag. The parts of the ladle most exposed to thermal and mechanical wear are the inner surfaces, mainly the bottom and the walls up to the half-height. Despite the use of protective coatings [5,11], the service life of slag ladles is also affected by the erosive-corrosive interaction between the liquid slag and the ladle inner surface. The chemical composition of the slag depends on the type of alloy melted and on the melting technology currently used. Steel slags contain mainly oxides such as SiO₂, Al₂O₃, FeO, MnO and remnants of melted alloy [5-6]. A common practice is to pour a new batch of slag into the ladle filled with the previously formed liquid slag, which creates temperature gradients between different parts of the ladle (flange, bottom and half of the ladle height), and additionally in the thermal nodes and casting wall cross-section [11,12]. Thus, the operating conditions of the slag ladles lead to the formation of local heterogeneities in the ladle microstructure (including the effect of segregation).

The operating conditions of the slag ladles, including the operation in cycles, lead to the generation of variable thermal

¹ AGH UNIVERSITY OF SCIENCE AND TECHNOLOGY, DEPARTMENT OF CAST ALLOYS AND COMPOSITE ENGINEERING, FACULTY OF FOUNDRY ENGINEERING, 23 REYMONTA STR., 30-059 KRAKOW, POLAND

² KRAKODLEW S.A., 1 UJASTEK STR., 30-969 KRAKOW, POLAND

* Corresponding author: bk@agh.edu.pl



stresses, which after exceeding the yield strength of the alloy can cause permanent plastic deformation of the ladle. With an increase in the number of operating cycles, a characteristic network of cracks appears on the inner surface of the ladle. Usually, the nucleation of cracks starts at grain boundaries and/or interphase boundaries, and in the case of castings also at non-metallic inclusions, which are an integral part of the cast material microstructure. Their presence is highly undesirable because it can lead to the formation of cracks on the entire cross-section of the ladle wall and, as a consequence, result in the loss of tightness and leakages, especially in the ladle bottom area.

Literature on the large-size slag ladles made of cast steel is rather scarce, and therefore it seems advisable to undertake tests carried out on decommissioned castings. Studies of this type may contribute to finding solutions and introducing changes that will extend the durability and reliability of such castings. Considering the design solutions used currently in the field of slag ladles, this issue seems to be of particular importance.

The main aim of this article is to present the results of tests and examinations of the microstructure and mechanical properties of samples taken from selected areas of the decommissioned slag ladles cast from low-carbon steel.

2. Experimental

Tests were carried out on a large-sized casting of a 16 m³ capacity slag ladle operating under industrial conditions. Samples were taken from three areas of the slag ladle with an average wall thickness amounting to 90 mm; i.e., from the ladle flange (denoted as K), bottom (denoted as D), and center of the side wall (denoted as S). Figure 1 shows a sampling scheme. The chemical composition of the samples taken from the selected parts (areas) of the slag ladle is shown in Table 1. The chemical analysis was performed on a Foundry Master Smart optical emission spectrometer.

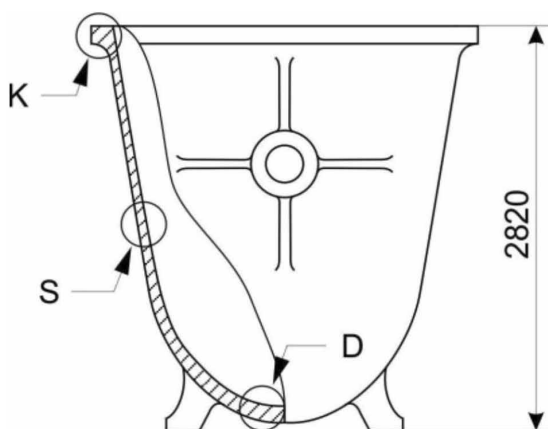

Fig. 1. Scheme of cutting out samples from slag ladle casting: D – bottom; K – flange; S – half-height of side wall of slag ladle

Metallographic examinations were carried out using a Leica light microscope, JEOL 5500LV scanning electron microscope

TABLE 1

Chemical composition of cast steel for slag ladle

Area of analysis	C	Mn	Si	P	S	Cr	Mo	Al	Fe
	wt. %								
K	0.28	0.61	0.39	0.012	0.013	0.10	0.035	0.029	balance
S	0.41	0.63	0.39	0.006	0.017	0.10	0.021	0.035	balance
D	0.33	0.64	0.40	0.005	0.018	0.10	0.020	0.036	balance

equipped with an EDS IXRF X-ray microanalysis system and transmission electron microscopy (STEM-HAADF). Samples for metallographic examinations were etched with nital (a solution of 2% HNO₃ in ethanol). The volume fraction of the phases (ferrite and pearlite) was determined with a Leica QWinV3 automatic image analyzer. The impact tests were carried out at room temperature on a Charpy hammer with an energy of 150 J using standard 10×10×55 mm samples with “V” notches. The fractures were examined by scanning electron microscopy at different magnifications. The mechanical tests and the determinations of UTS, YS, and EL were carried out on an INSTRON 5982 machine using the following parameters: strain gauge of 100 kN; clip-on extensometer with base of 50 mm, strain rate of 10⁻² 1/s. The hardness was measured with a Brinell HPO 250 hardness tester applying a load F = 613 N and a ball-shaped indenter with a diameter of 2.5 mm, the measurement time was 15 s.

3. Results and discussion

3.1. Characterization of microstructure

The visual assessment of the test material cut out from the three zones of a large-size slag ladle casting (flange, bottom and half-height) shows a network of cracks occurring mainly in the sample taken from the bottom of the ladle (Fig. 2). Apart from the very demanding operating conditions, the presence of cracks in this area can have its additional origin in the slag ladle casting

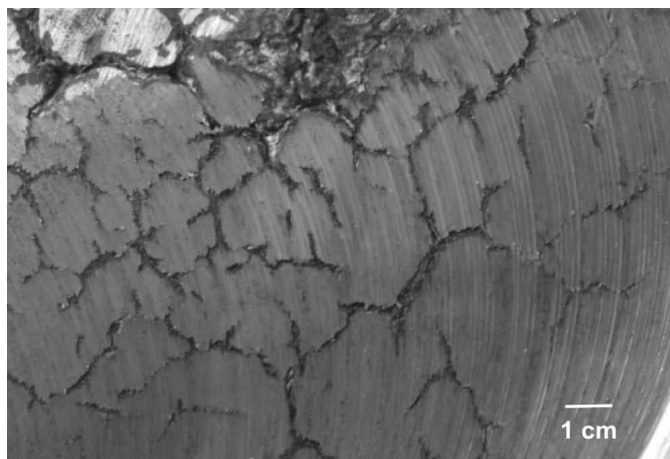

Fig. 2. A fragment of the surface of the ladle bottom with a network of cracks revealed after machining and levelling of the ladle working surface

technology (including pouring regime and casting solidification in a foundry mould). Taking into account the very difficult conditions under which the large slag ladles are expected to operate, it can be assumed that these are the fatigue – thermal cracks.

The metallographic examinations revealed some differences in the microstructure of the samples taken from different areas of the casting. The differences are mainly due to the ladle operating conditions, i.e. repeated cycles of pouring the liquid slag in and out, which can be compared to the cyclic heat treatment of cast steel from which the ladle is made.

The microstructure of samples taken from the flange and bottom of the ladle is typical for the cast steel containing 0.3 wt.% C and consists of ferrite and pearlite (Fig. 3). The microstructure images show areas where Widmannstätten ferrite occurs and areas where it is clearly fragmented. The presence of acicular Widmannstätten ferrite reduces the mechanical properties of cast steel and makes it more sensitive to crack formation. Probably, the occurrence of ferrite with such an unfavourable morphology is due to the large thickness (90 mm) of the ladle wall and high operating temperature. The content of ferrite in samples taken

from different areas of the ladle was similar and amounted to 55 wt.% and 53 wt.% for the ladle bottom and flange, respectively. On the other hand, Figures 4-6 show the microstructure of the sample cut out from the ladle half-height. Compared to the structure obtained in the other two areas, this microstructure has undergone some unfavourable changes and consists of a ferritic matrix with spheroidal precipitates occurring mainly at grain boundaries (Figs. 4b, 5a).

Studies of these precipitates carried out by transmission microscopy show that they are composed of $(\text{Fe,Mn,Cr})_3\text{C}$ carbides (Fig. 6). The change in the morphology of cementite plates present in pearlite to spheroidal shape is associated with the thermodynamic conditions (decrease in ferrite-carbide inter-phase energy) changing during ladle operation. The kinetics of the spheroidization process of cementite precipitates is controlled by diffusion of carbon and other elements in the matrix [13-16].

Studies of the microstructure also revealed the presence of graphite precipitates, which constitute a phase characteristic of high-carbon iron alloys (Figs. 4a, 7). The occurrence of graphite at the ladle half-height (designated as area S) results, among

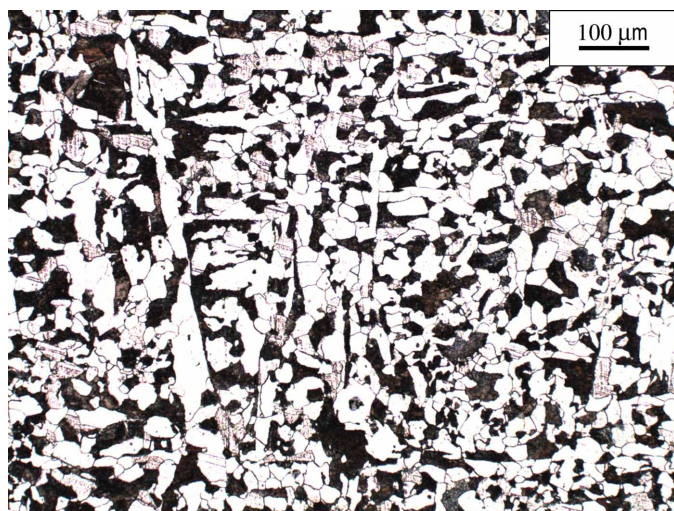

a)

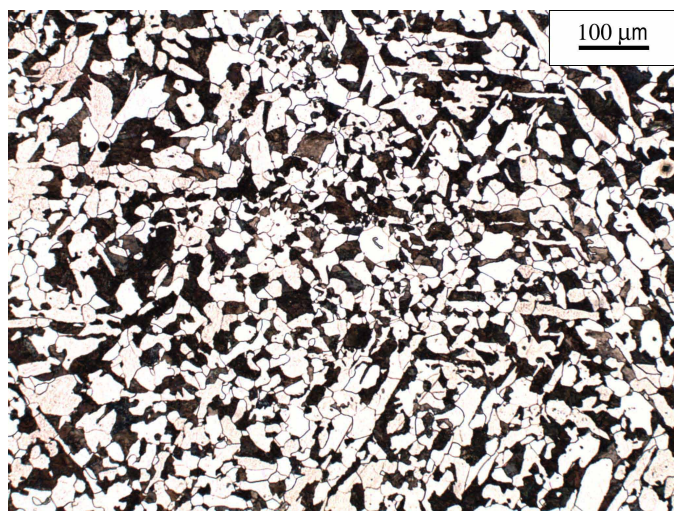

b)

Fig. 3. Representative optical micrograph from slag ladle: a) bottom of ladle; b) flange of ladle etched with nital reagent

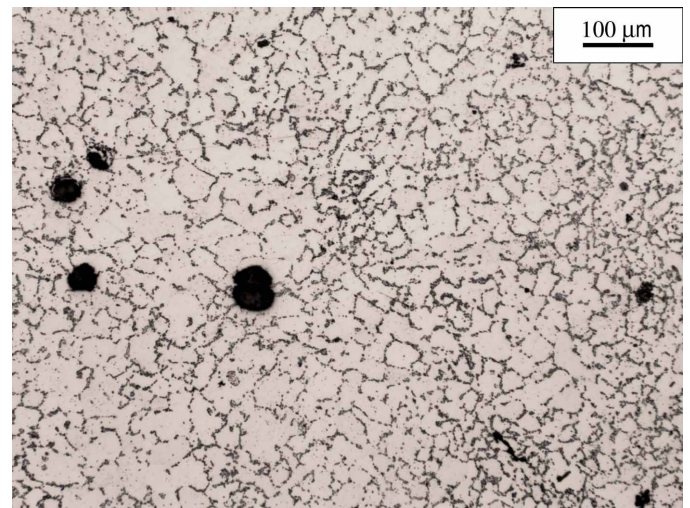

a)

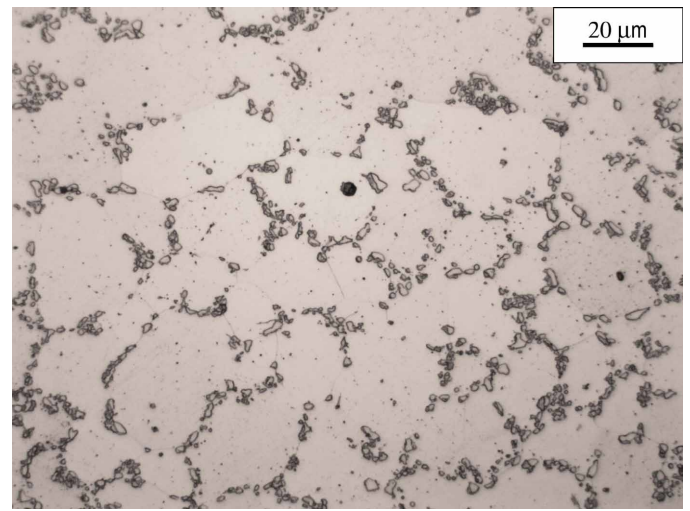

b)

Fig. 4. Representative optical micrograph from half-height of ladle etched with natal reagent

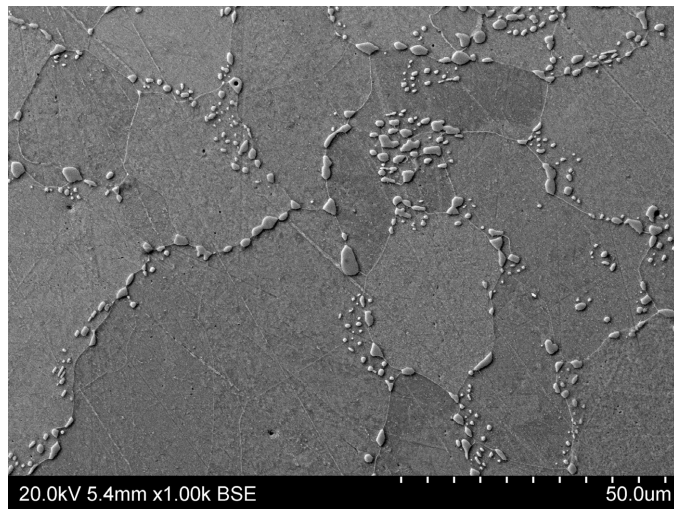

a)

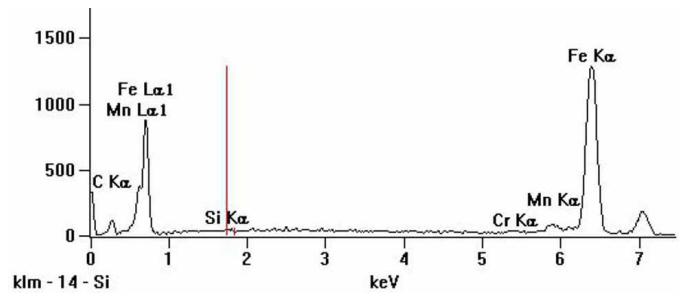

b)

Fig. 5. Ferritic matrix with precipitates of cementite from half-height of ladle – a), X-ray diffraction pattern and EDS spectra showing precipitates of cementite – b)

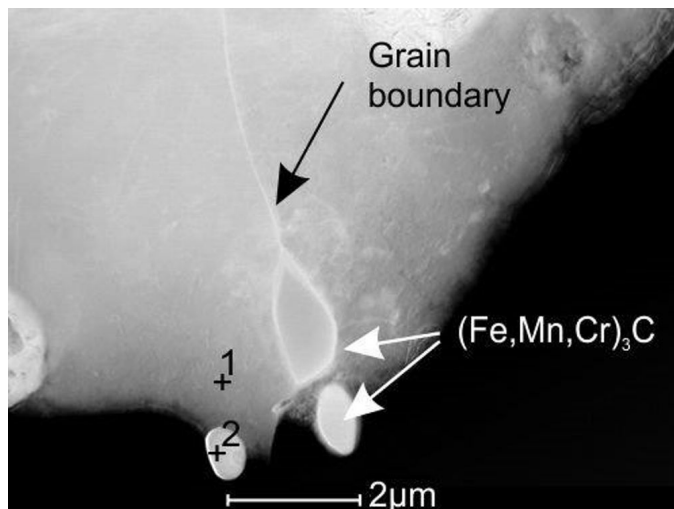

a)

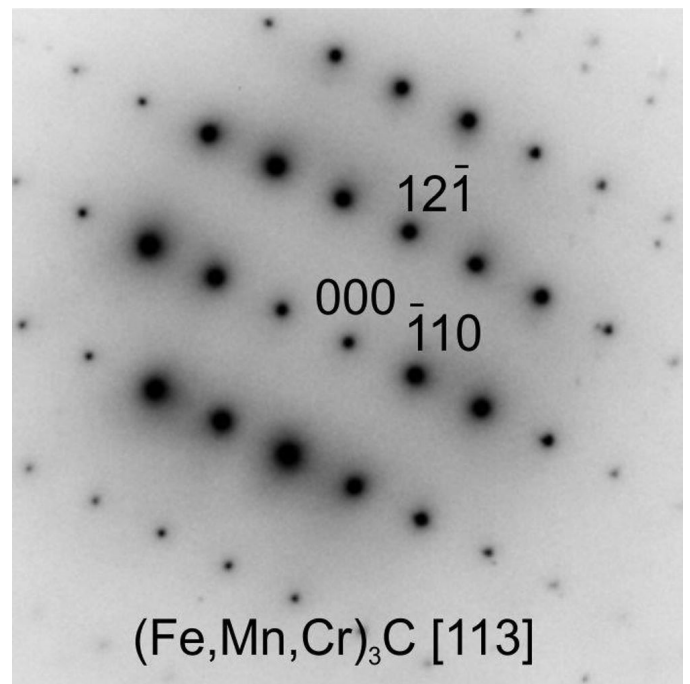

b)

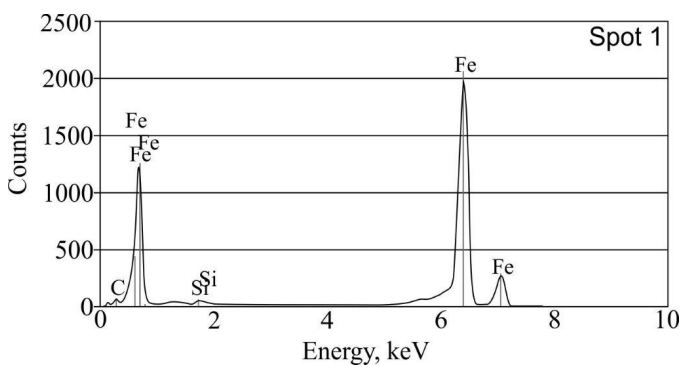

c)

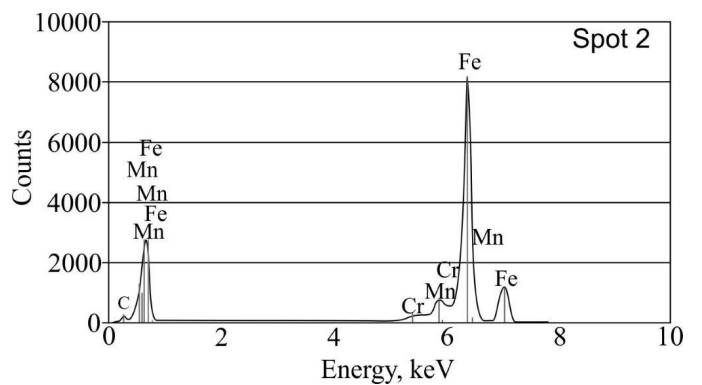

d)

Fig. 6. TEM image of examined specimen S – a); electron diffraction of M_3C – b); EDS analysis of Spot 1 – c); and Spot 2 – d)

others, from carbon diffusion due to cyclic temperature-stress interaction after repeated cycles of filling the ladle with liquid slag [11,12]. The presence of graphite precipitates in the matrix of large-size steel castings can prevent the fatigue and thermal cracks from spreading deep into the material from which the casting is made [17].

It is worth noting that, despite the presence of spheroidal (Fe,Mn,Cr)₃C precipitates, changes observed in the ladle microstructure and transition from the ferritic-pearlitic microstructure (areas designated as K and D) into a ferritic microstructure (area designated as S) may lead to a decrease in hardness and accelerated wear of cast steel used for the slag ladle.

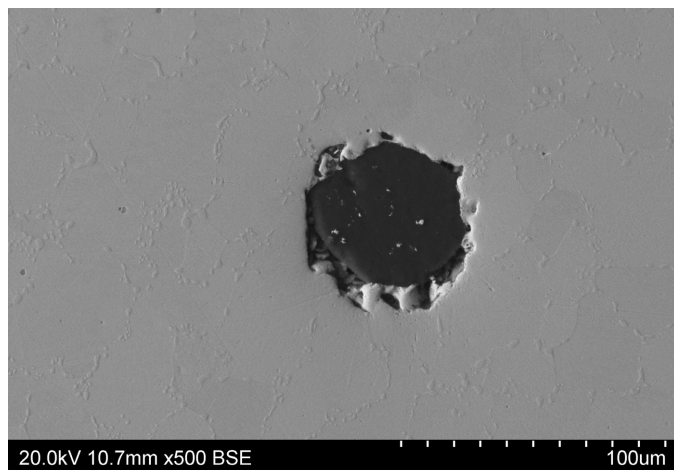

a)

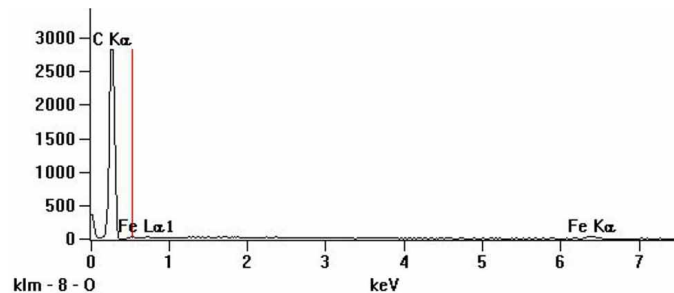

b)

Area	Chemical composition				
	wt. %				
	C-K	Si-K	Cr-K	Mn-K	Fe-K
graphite	96.9	-	-	-	3.1
matrix	3.3	0.5	-	0.5	95.7

c)

Fig. 7. SEM micrograph of graphite in microstructure from flange of the ladle from Fig. 4a – a), X-ray diffraction pattern and EDS spectra showing precipitates of graphite from Fig. 7a – b), microanalysis of chemical composition: graphite and matrix – c)

3.2. Mechanical properties

The Charpy test results show large differences between the ladle half-height and the flange and bottom (Fig. 8). This is mainly due to differences in the microstructure obtained in

these areas (Figs. 3, 4, 7). The average impact energy of samples taken from area S of the ladle is 14 J. Obtaining the impact energy so low in carbon cast steel is caused, among others, by the presence of graphite precipitates in a ferritic matrix and (Fe,Mn,Cr)₃C cementite network formed at grain boundaries (Figs. 6, 8). In other areas of the ladle (flange and bottom) with a ferritic-pearlitic microstructure, the impact energy exceeds 30.4 J, which for cast steel is a value slightly higher than the value of the impact energy corresponding to the ductile-to-brittle transition temperature.

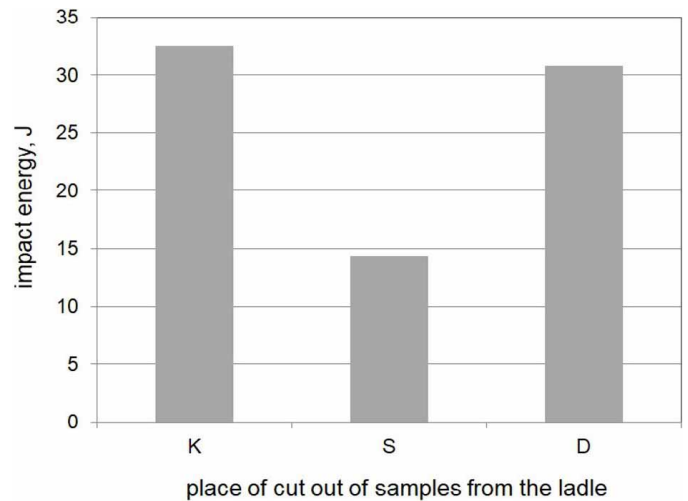

Fig. 8. Changing impact energy depending on places where sample was cut from slag ladle: K – flange; S – half-height of slag ladle; D – bottom of ladle

Similar changes were observed in hardness measurements, although the difference between ladle half-height and bottom was not as pronounced as in the case of impact strength (Fig. 9). Comparable hardness in these zones might be the effect of segregation processes and discontinuities occurring in the microstructure. Quite interesting are also high values of hardness in the flange zone, most probably due to lower temperature and different

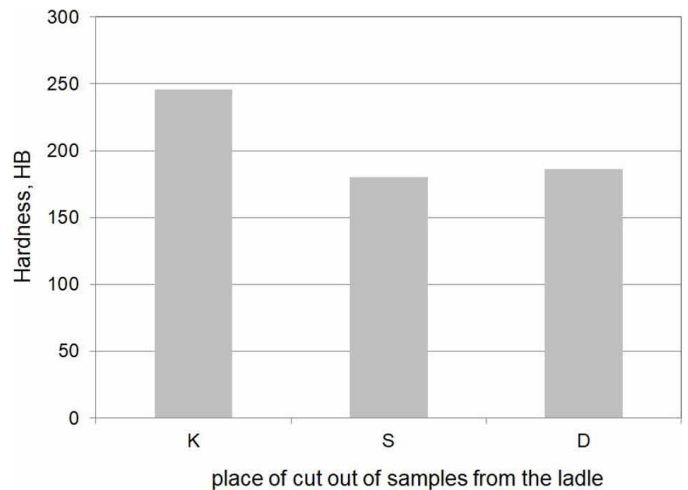

Fig. 9. Change in hardness depending on places where sample was cut from slag ladle: K – flange; S – half-height of ladle; D – bottom of ladle; (average of four measurements)

thermal conditions (faster heat dissipation) occurring in this part of the ladle during its operation. It should be remembered that low hardness in some parts of the ladle will ultimately increase the wear of these parts.

Based on the static tensile test, the tensile strength, yield strength and elongation of cast steel were determined in selected areas of the slag ladle. The obtained results of UTS and YS measurements are shown in Figure 10, and the results of EL measurements in Figure 11. As in the case of the impact and hardness tests described earlier, it was found that the lowest values of UTS and YS were recorded in the area of the ladle half-height (designated as area S). The largest differences between flange/bottom zone of the ladle and area S (reaching about 160 MPa) were recorded for the tensile strength UTS. The difference in the values of the yield strength YS between the flange and the half-height of the ladle was 35 MPa, and 60 MPa between the bottom and the half-height of the ladle (Fig. 10). As in the previously discussed cases, also in this case the factor that had a decisive influence on the obtained values was the cast steel microstructure in the examined areas. The low value of YS in the area of the ladle designated as S will be responsible for plastic deformation of this part of the ladle during operation [11,12].

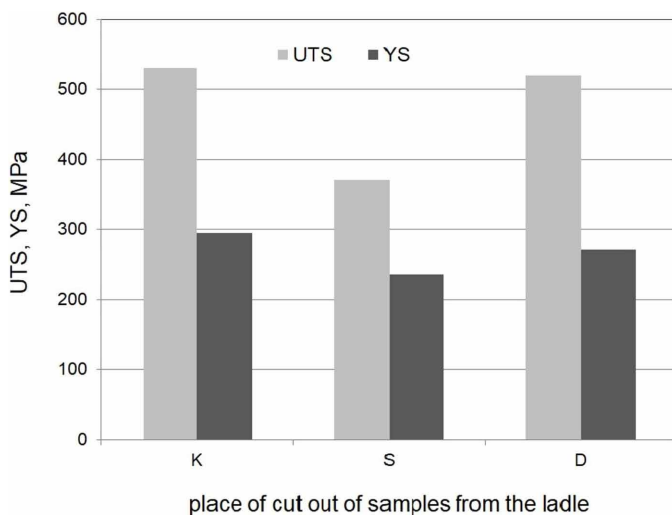

Fig. 10. UTS and YS depending on places where samples were cut from slag ladle: K – flange; S – half-height of ladle; D – bottom of ladle; (average of three measurements)

Figure 11 shows the average values of elongation obtained in the examined areas of the ladle. The results confirm the occurrence of the commonly known correlation between the mechanical properties of non-alloy cast steel, according to which high strength properties, i.e. UTS and YS, are accompanied by low elongation [18].

3.4. Fractography

The visual assessment and microscopic examinations of fractures formed in impact tests show the mixed character of these fractures with a predominant share of brittle fracture and

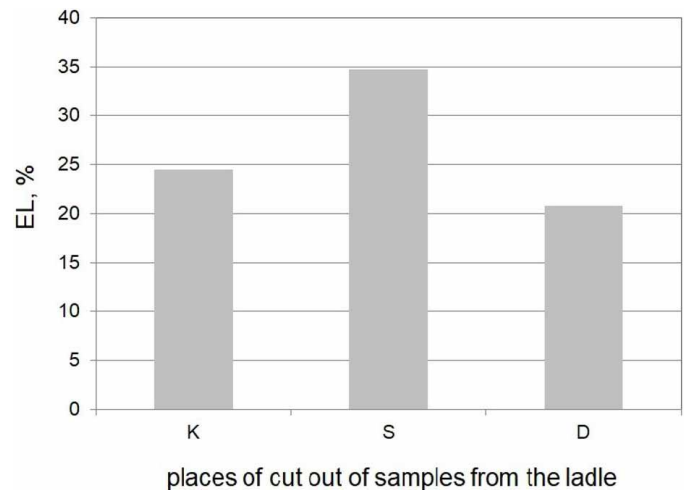

Fig. 11. Results of elongation (EL) depending on places where samples were cut from slag ladle: K – flange; S – half-height of ladle; D – bottom of ladle

numerous micro-cracks occurring especially in samples taken from the ladle half-height and bottom (Figs. 12, 13). In area S of the ladle, along with microcracks, numerous porosities are observed (Fig. 14a), accompanied by clusters of non-metallic inclusions visible especially at high magnifications (1000×). Their presence also contributes to the reduction of the mechanical properties of cast steel used for the tested slag ladle (Fig. 15). The inclusions probably have their origin in the technology by which the liquid steel is processed before being poured into foundry moulds.

Additionally, SEM studies showed the presence of spheroidal graphite precipitates in the fracture of sample taken from area S (Fig. 16).

4. Conclusions

Tests were carried out on samples of material taken from a large casting of the decommissioned slag ladle. The obtained results showed that the main factors reducing the ladle durability were thermal-mechanical interactions changing in cycles and accompanied by thermal stresses. Based on the conducted research, the following conclusions were formulated:

- differences were found in the slag ladle microstructure between its flange, bottom and centre of the wall height. In the ladle flange and bottom areas, the microstructure was ferritic-pearlitic with a comparable fraction of ferrite and pearlite and a few ferrite grains in the Widmannstätten system. In contrast, in the central part of the ladle height, the microstructure was composed of a ferritic matrix, $(\text{Fe,Mn,Cr})_3\text{C}$ cementite precipitates forming a network along grain boundaries and graphite precipitates,
- studies of UTS, YS, impact energy and hardness showed that the lowest mechanical properties were obtained at the ladle half-height as compared to the results obtained in the ladle flange and bottom areas. The above mentioned properties

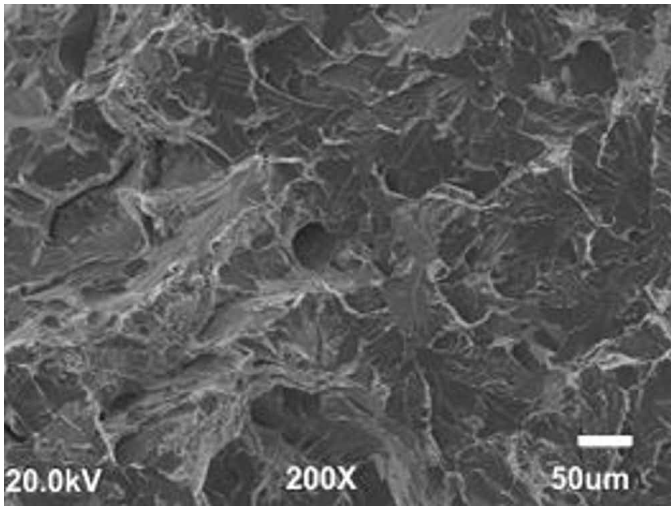

a)

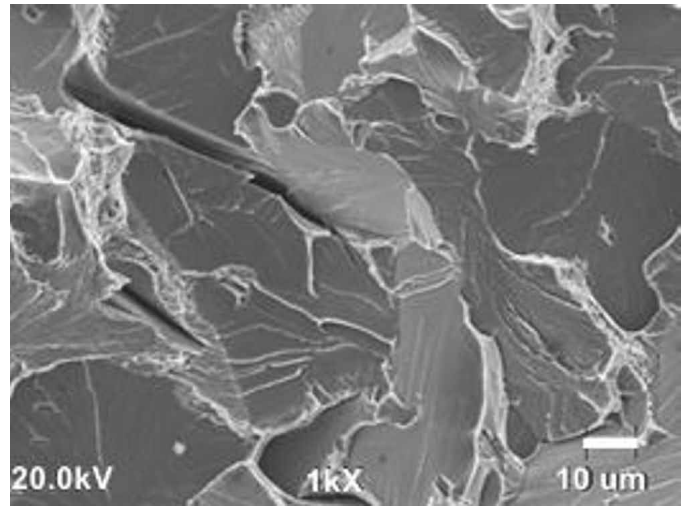

b)

Fig. 12. SEM image showing fractures – area D of slag ladle after tensile test

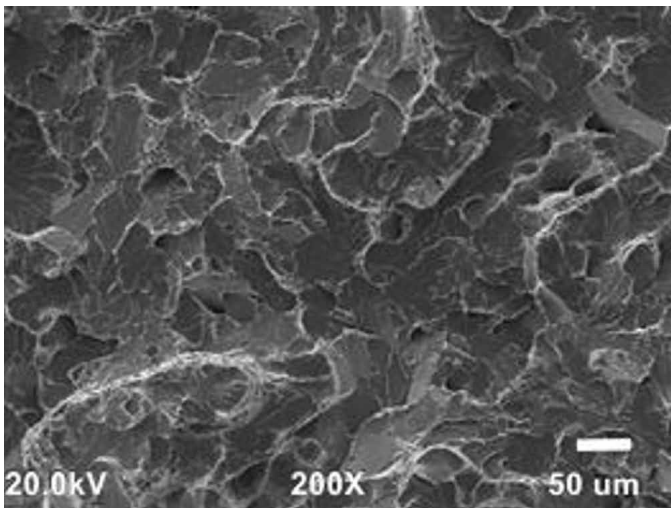

a)

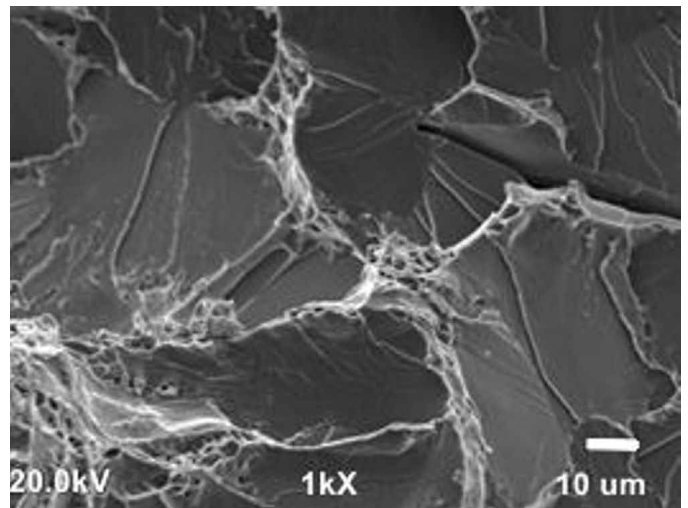

b)

Fig. 13. SEM image showing fractures – area S of slag ladle

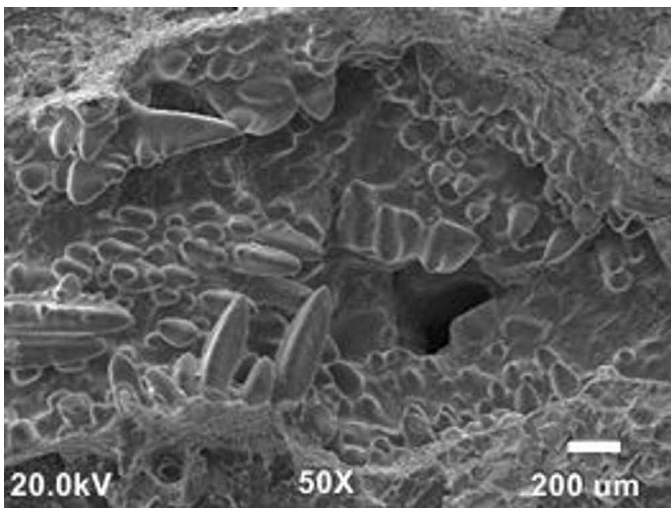

a)

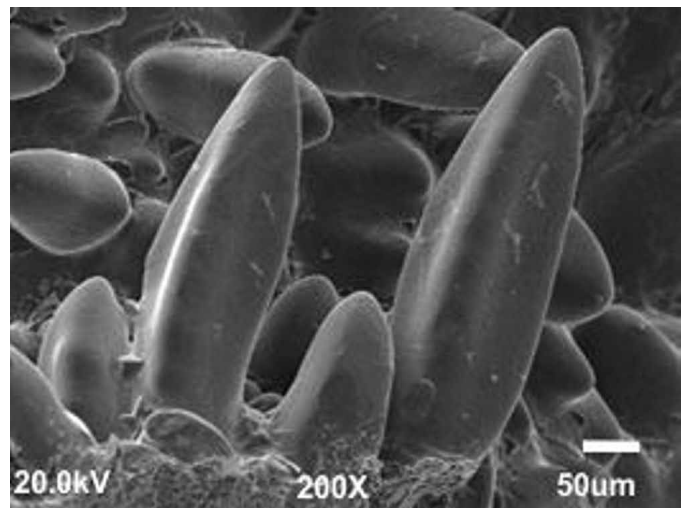

b)

Fig. 14. SEM image showing microporosity – area S of slag ladle

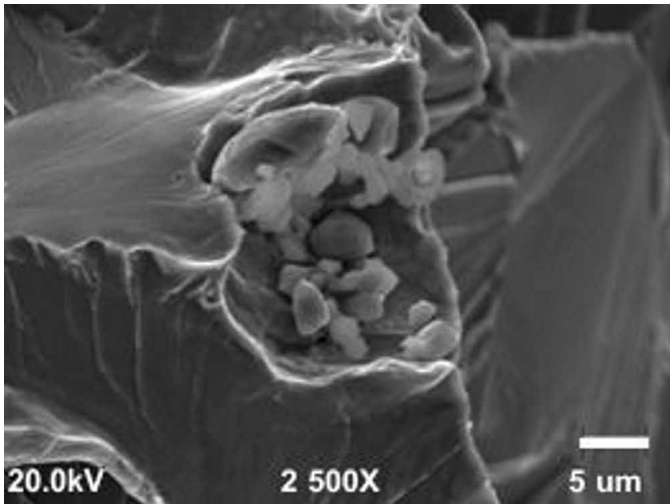

Fig. 15. SEM image showing non-metallic inclusions – area S of slag ladle

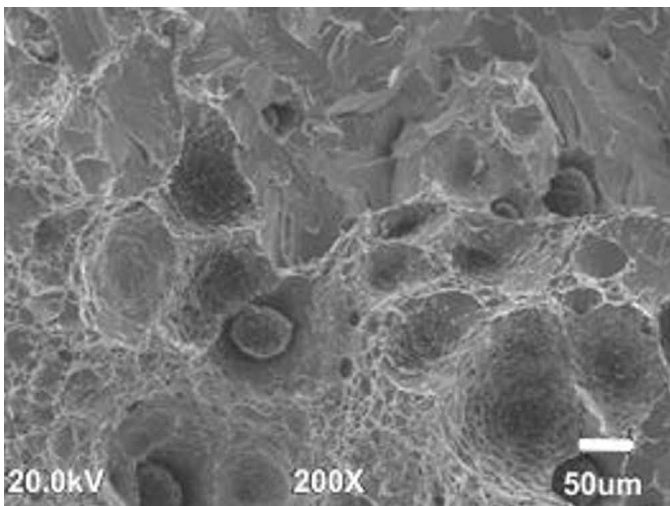

Fig. 16. SEM image showing graphite balls on fracture – area S of slag ladle

were affected by both the microstructure and the identified microstructural heterogeneities,

- fractography revealed the mixed character of fractures with the predominance of brittle fracture in all ladle areas. Additionally, microporosity and graphite precipitates were found in fractures from the ladle half-height, which reduced the mechanical properties in this part of the slag ladle as compared to the areas in the ladle flange and bottom,
- judging from the results obtained it seems possible to extend the life and durability of cast steel slag ladles by application of appropriate treatments mitigating the ladle degradation process and introducing some modifications to the examined slag ladle areas. Such modifications could be introduced even at the stage of making the slag ladle

casting (e.g. when the casting mould is prepared) or at the stage when adjustments in the chemical composition of cast steel used for slag ladles are made.

Acknowledgements

This work has been partially executed under a Research Project P1.1.1-PG-09-001.

REFERENCES

- [1] J. Dańko, M. Holtzer, *Metody ograniczenia odpadów z procesów odlewniczych oraz sposoby ich zagospodarowania*, Akapit Kraków (2010).
- [2] A. Pribulová, P. Futá, D. Baricová. *Production Engineering Archives* **11** (2), 2-5 (2016).
- [3] M. Mercado-Borrayo, J.L. Gonzalez-Chavez, R.M. Ramirez-Zamora, R. Schouwenaars, *Journal of Sustainable Metallurgy* **4**, 50-67 (2018). <https://doi.org/10.1007/s40831-018-0158-4>
- [4] M. Gawlicki, J. Małolepszy, *Nowoczesna Gospodarka Odpadami* **1-2**, 15-20 (2015).
- [5] E.L. Pisila BSc thesis, *Developing Practice for Protective Sand in Slag Pots*, University of Oulu, Finland (2017).
- [6] I. Jończy, L. Lata, *Górnictwo i Geologia* **8** (4), 51-61 (2013).
- [7] J. Pogorzalek, P. Różański, *Prace IMŻ Gliwice* **1**, 281-285 (2010).
- [8] PN-EN 1563: (2018) – Foundry. Ductile Iron.
- [9] DIN 1681: (1985). Cast Steel for General Purpose – Technical Delivery Conditions from SAI Global.
- [10] DIN 17182: (1992). General – Purpose Steel Castings with Enhanced Weldability and Higher Toughness – Technical Delivery Conditions.
- [11] H. Rojacz, I.A. Neacsu, L. Widder, M. Varga, J. Heiss, *Wear* **350-351** (15), 35-45 (2016), DOI: 10.1016/j.wear.2015.12.009
- [12] I.A. Neacsu, B. Scheichl, H. Rojacz, G. Vorlauffer, M. Varga, H. Schmid, J. Heiss, *Steel Research* **87** (6), 720-734 (2016), DOI: 10.1002/srin.201500203
- [13] J.X. Gao, B.Q. Wei, D.D. Li, K. He, *Materials Characterization* **118**, 1-8 (2016), DOI: 10.1016/j.matchar.2016.05.003
- [14] S.S. Krishanan, N. Balasubramanian, *Treatise on Process Metallurgy. Industrial Processes, Part A*. Elsevier Cambridge (2014).
- [15] R.A. Schaneman, PhD thesis, *The Effects of Prior Microstructure on Spheroidizing Kinetics and Cold Workability in Bar Steels*, Colorado School of Mines, USA (2009).
- [16] A. Inam, R. Brydson, D.V. Edmonds, *Materials Characterization* **131**, 509-516 (2017), DOI: 10.1016/j.matchar.2017.07.040
- [17] J. Krawczyk, J. Pacyna, R. Dąbrowski, *Inżynieria Materiałowa* **77** (3), 174-177 (2006).
- [18] J. Głownia, *Metallurgy and Technology of Steel Castings*. Sharjah Bentham Books (2017).