

## NEW POSSIBILITY FOR THE USE OF PLASMA DISCHARGES TO IDENTIFY AMBER AND CHANGES IN AMBER STRUCTURE

Sebastian Gnapowski<sup>1</sup>, Klaudiusz Lenik<sup>2</sup>, Grzegorz Szwed<sup>2</sup>, Hidenori Akiyama<sup>1</sup>

<sup>1</sup> Graduate School of Science and Technology, Frontier Technology for Electrical Energy, Kumamoto University, 2-39-1 Kurokami, Kumamoto, 860-8555, Japan.

<sup>2</sup> Fundamentals of Technology Faculty, Lublin University of Technology, ul. Nadbystrzycka 38, 20-618 Lublin, Poland, e-mail: k.lenik@pollub.pl; g.szwed@pollub.pl

Received: 2012.10.22

Accepted: 2012.12.03

Published: 2012.12.21

### ABSTRACT

Pulsed power discharge applied in air to the amber surface was found to cause improvement in its appearance and color changes such as to red, a color not natural to amber but attractive for jewelry. Needle and plate electrodes were used during experiments. Pulsed power discharges in air particularly turned amber red at the edges and around the needle electrode. Discharges in water did not change amber structure because discharge occurring on the surface does not cross the amber structure. Discharges in silicone oil had a different effect, with most discharge passing through the amber structure, causing fine cracks. Unfortunately, the absence of a consistent amber structure causes difficulty in selecting the correct discharge (shock wave) power. Using new technology, we have changed the appearance a very old material-amber (about 40 – 60 million years old) – to make it more attractive for customers; this technology is also useful for detecting artificial amber (costume jewellery) without causing damage to the product.

**Keywords:** amber, pulsed power plasma discharge, shock wave, cracks, silicone oil, red color amber.

### INTRODUCTION

Amber is a mineral of many names: jantar, good stone, sacred stone, gold of the north, Baltic gold and the electron. Amber is also a mineral of many colors. Depending on the age, amber nuggets range from nearly white through all shades of yellow and orange.

Fossilized bits of animals and plants dating back over 120 million years are often found in amber formations [1]. Amber gives an aromatic odor when burned, unlike plastic imitations. Chemically, amber consists of several resinous compounds which are soluble in alcohol, ether or chloroform. Baltic amber contains about 8% succinic acid, it is also termed succinite [2].

Amber has been an object of admiration and interest for centuries. Its beauty, pleasing smell

and ease of processing have always earned it a place among decorative stones [3]. The most vivid interest, however, has for centuries been stirred by inclusions. Lumps of amber frequently feature insects and plant fragments, bits of life from times millions of years ago sunk in resin and preserved forever. Figure 1 shows the resin fossilization process that produces amber. Scientists are endeavoring to make amber more beautiful and thus more attractive for customers. In our laboratory (Kumamoto University, Graduate School of Science and Technology), we applied a new technology, pulsed power, to a very old material, amber. Using a pulsed power plasma discharge in air, the surface of amber changed color to red, which is not a color natural to amber. Our next experimental step was the use of pulsed power plasma discharge in water and in silicone oil. The purpose of this experiment

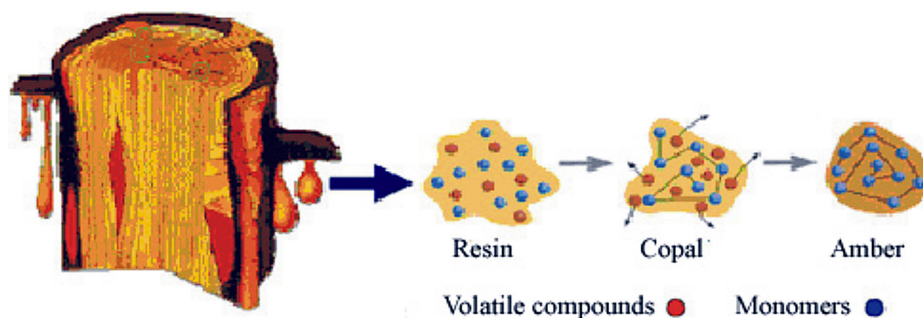

Fig. 1. Resin fossilization process that produced amber

was to make small cracks by shock wave and to change the amber interior structure.

### EXPERIMENTAL PROCEDURES

The experiments utilized needle, wire, and plate electrodes. All experiments were carried out at atmospheric pressure. Current and voltage signals were processed by a digitizing oscilloscope (Tektronix DPO 71604 Digital Phosphor Oscilloscope 520 A; 4 channels, 16 GHz, 50 GS/s) and the voltage at the reactor was measured by a high voltage probe (Nissin Pulse Electronics CO.LTD EP-150KP). The discharge current through the coaxial electrode was measured using a Rogowski coil (MODEL 6600, voltage pre ampere 0.01 Pearson current monitor, Pearson Electronics, Inc., Palo Alto, CA, USA). A pulsed power generator system (ATPS-02, developed by Meidensha Corporation, Numazu-City, Shizuoka, Japan) was used. Applied voltage was around 110 kV and 40 Joules per shot. Two types of microscopes are used to photograph the microstructure in alga photographs: a Fluorescent Stereo Microscope Leica M165 FC, whose fully apo-chromatic corrected stereo microscope with 16.5:1 zoom optics

resolves structures down to 1.1  $\mu\text{m}$  for detailed fluorescent imaging; and a Nikon Eclipse Ti Advanced inverted microscope system, which offers very high functionality, including built-in perfect focus and high speed motorization. A schematic of the experimental set-up consisting of a discharge reactor and electrical circuit is shown in Figure 2.

### DISCUSSIONS ABOUT EXPERIMENTAL RESULTS

#### Pulsed power plasma discharge in the air

Pulsed power plasma discharge in air was our first experiment. 30 pps (pulse per second) were applied for 10 seconds. The discharge did not penetrate amber, instead just appearing on the amber surface. After pulsed power plasma discharge treatment, the amber's surface became smoother and its color changed to red, which is not a natural color for amber. Application of fire (such as from a burner) can also change amber color but to cherry-red (a bit dark cherry color). Unfortunately, there are other materials on the market that are called red, or cherry, amber, which are not amber at all, but are imitations or artificial amber.

As red amber has always been sought after, it has been imitated in less expensive materials, notably plastics. Red amber imitations were very popular in the early to mid twentieth century, when good quality artificial ambers were mass produced in cast phenolic resin. It is worth noting that, while the clear red phenolic beads may imitate amber, the natural material never occurs in opaque red, so the opaque beads have been 'imitating' something that does not exist. Pulsed power plasma discharge can change color by temperature and pressure. The temperature changes surface color; shock wave cause high pressure,

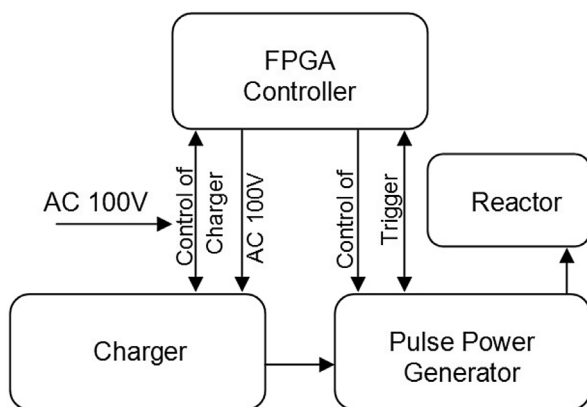

Fig. 2. Experimental setup

which smoothes and shines the amber surface. The density of the red color shade can be controlled by pulse number and voltage. Figure 3 illustrates the experimental setup; Figure 4a shows an amber sample before discharge, and the experimental result, amber after discharge, is shown in Figure 4b. Applied voltage and current are shown in Figure 5. While amber turned red by thermal treatment is not transparent, that turned red by pulsed power plasma discharge is transparent: amber which is transparent prior to treatment remains transparent.

**Pulsed power plasma discharge in the silicone oil**

Figures 6 and 7 shows amber after pulsed power plasma discharge in silicone oil in which 10 single shots were applied. Figure 6a is an am-

ber before experiment; its structure was transparent. After pulsed power plasma discharge treatment in silicone oil, small cracks appeared in the amber interior, and in samples (Fig. 6b and 6c), the interior color was changed. This phenomenon was caused by shock waves.

The sample in Figure 7 shows separated layers and the largest cracks. As amber is a layered structure, an important parameter is the direction of discharge. Shock waves after pulsed power plasma discharge in silicone oil cause separation of amber layers and small cracks. The direction of cracks is dependent on the placement of pulsed power plasma discharge and the orientation of amber layers. Cracks in amber interior are colloquially known as fish scales. The interior of small cracks may display a red color. This phenomenon was observed by microscope, as shown in Figure 8. Red colors are concentrated on the edge of the

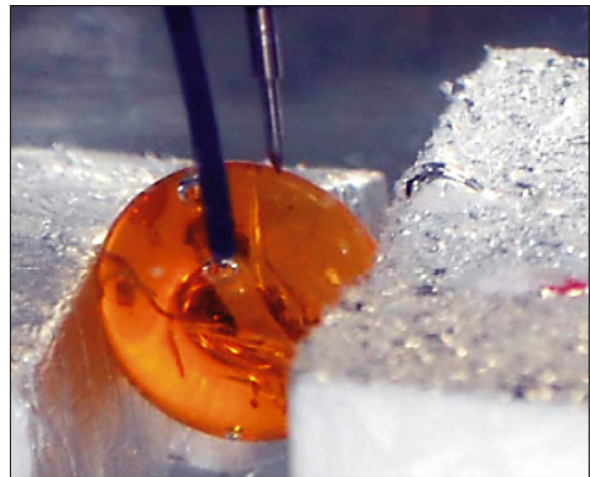
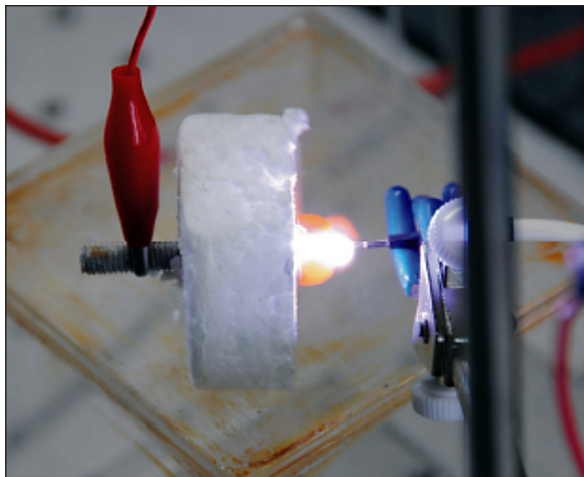

**Fig. 3.** Pulsed power plasma discharge in air and in silicone oil (amber diameter ø 15 mm)

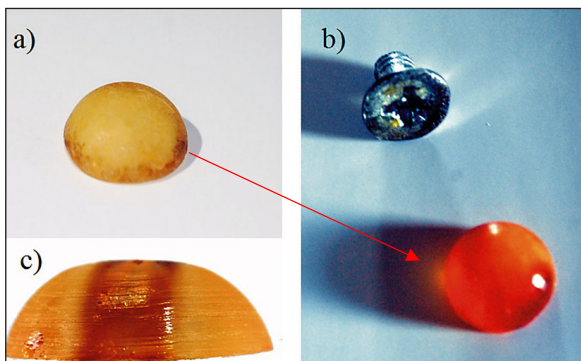

**Fig. 4.** Amber after (a) and before (b) treatment by pulsed power plasma discharge in air, (c) amber after 5 pulses

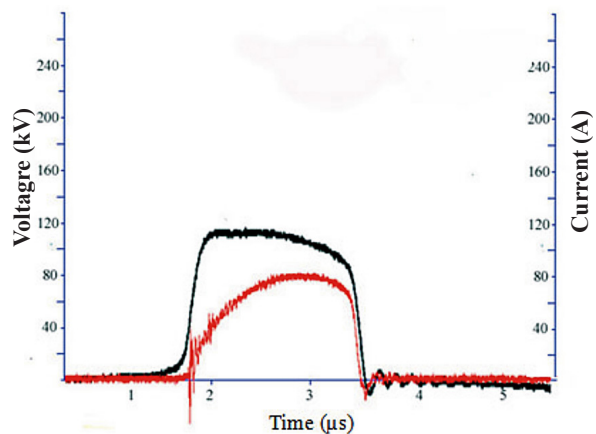

**Fig. 5.** Waveforms of the applied voltage and the discharge current

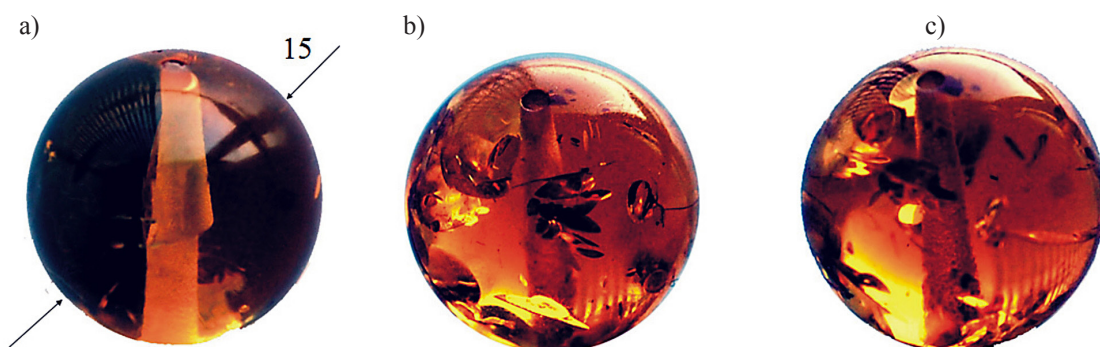

Fig. 6. Amber before and after treatment by pulsed power plasma discharge in silicone oil

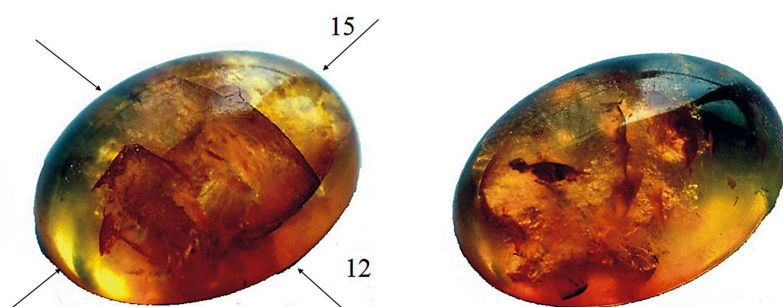

Fig. 7. Amber before and after treatment by pulsed power plasma discharge in silicone oil (delaminate effect)

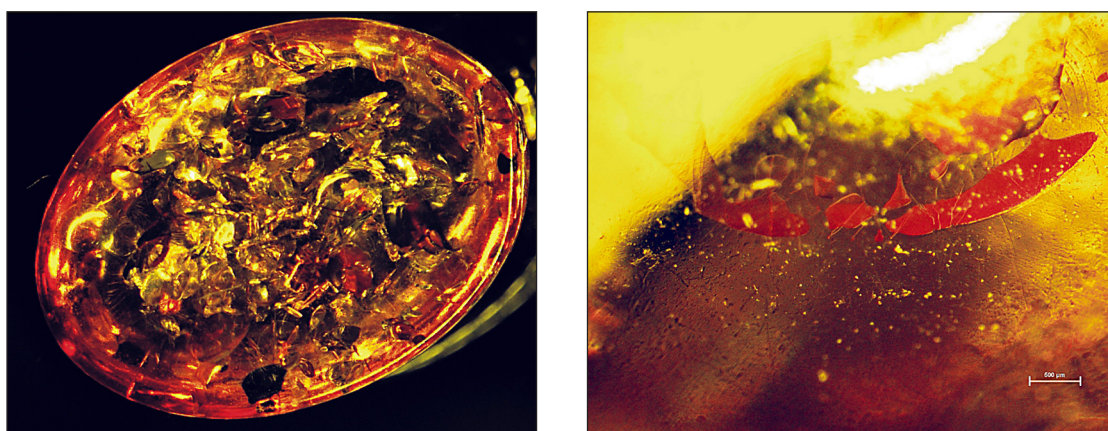

Fig. 8. Microscope picture of amber after surface pulsed power plasma discharge

amber sample; energy accumulated too on the amber edge, and the red color is probably an effect of energy accumulation.

### Amber identification

Unfortunately, rising prices and popularity of amber goods have stimulated the production of artificial amber, which is continuously improved and manufactured in ever-increasing quantities. Only infrared absorption spectroscopy may reliably check whether a given piece of Baltic amber

is real. It is possible that the use of our method will enable a check of amber authenticity. Artificial amber is uniform – that is, it lacks a layered structure. Thus, discharge does not crack the interior of artificial amber. Properties of amber are difficult to identify, with the best test being infrared absorption spectroscopy (IRS).

Amber research and identification is difficult as amber does not dissolve fully in any currently known solvent. FTIR Spectroscopy is an effective and reliable method, where a section of the curve called “the Baltic arm” formed in the

1200–1260  $\text{cm}^{-1}$  band range is the diagnostic determinant. One of the many methods used today is a succinct identification of infrared absorption spectroscopy (IRS). The curve obtained as a result of the test indicates the amount of absorption of monochromatic light passing through a prepared pellet of potassium bromide (KBr), beaten with amber. Its shape varies with the wavelength determined by the wave number in  $\text{cm}^{-1}$ . The absorption is related to the vibration of bonds in functional groups (eg OH, CH,  $\text{NO}_2$ ,  $=\text{CH}_2$ ), molecules of organic compounds included in the amber. Transmitted light is expressed as a percentage value of the transmission, which determines the ratio of the light beam to the incident. An amount of amber sufficient for the study is 1.5–2 mg.

Identification by IRS is the cheapest and most basic exploratory analysis for identification of succinct. A succinct curve has a very distinct section of the diagnostic arm of the Baltic, which is formed from the combination of bands of equal intensity in the range 1200–1260  $\text{cm}^{-1}$ . The intensity of absorption is also dependent on the degree of weathering of amber, but the overall shape of the curve remains unchanged as for amber heated and pressed. This method is invasive, requiring a small sample cut from the amber.

The use of pulsed power plasma discharge allows recognition of real amber without an invasive method, which would damage the sample. For these experiments, we used four types of artificial amber under the same parameters as for real

amber including shot number and voltage. The first step was surface pulsed power plasma discharge in air. The artificial amber did not change color, though the surface turned to a matte color. Figure 9 shows the surface of artificial amber after 30 pps at 10 seconds treatment. Increases in shot number or applied voltage increase result led to the same results.

The next experiment was pulsed power plasma discharge in silicone oil. When 10 single shots were applied to a real amber, small cracks appeared in the interior. When a single shot was applied to the artificial amber, it was completely destroyed.

Figure 10 shows artificial amber after a single shot. Artificial amber structure is completely different from real amber. Voltage decreased by 80% led to the same result: artificial amber was destroyed after one shot. White and red color artificial amber is stronger because its hardness is different, but this artificial amber was destroyed as well. The hardness of real amber and that of four artificial amber types were measured. Figure 11 shows hardness of artificial amber.

Figure 11 shows four types of artificial amber, after single shots in silicone oil. I can say hardness artificial amber is similar like real amber. Artificial amber does not stretch and has a uniform construction. Microscope observation shows that the damaged artificial amber is internally uniform, with a flat and uniform surface. After being damaged real amber is not uniform, with many cracks. This experimental data indicates that this simple method is valuable for recognition of real amber without causing damage to specimens.

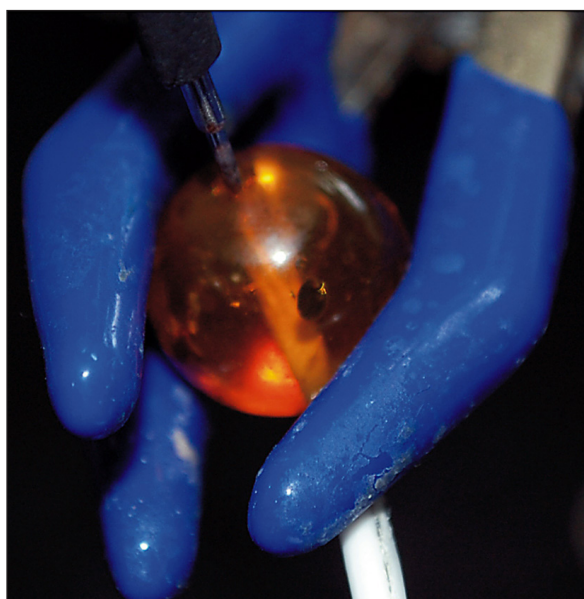

**Fig. 9.** Artificial amber after pulsed power plasma discharge in air (matte surface)



**Fig. 10.** Artificial amber after pulsed power plasma discharge in silicone oil (single shot)

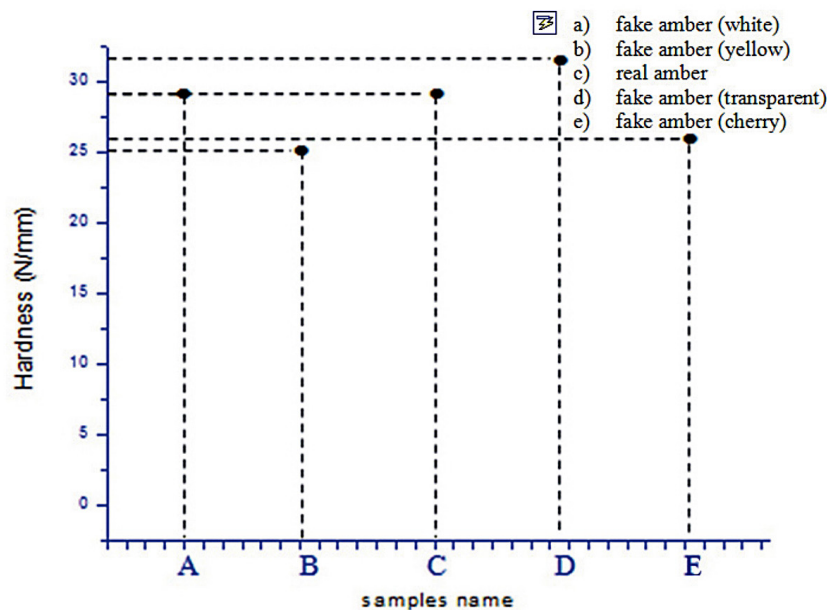

Fig. 11. Hardness of real and artificial amber

## CONCLUSION

1. Shock waves change amber structure, separating amber layers.
2. Using pulsed power plasma discharge allows recognition of real amber without causing damage to specimens.
3. Pulsed power plasma discharge in silicone oil makes amber red in its interior.
4. Pulsed power plasma discharge in silicone oil can make small cracks inside amber
5. Pulsed power plasma discharge in water was not useful for changing amber structure.
6. The results show that we can connect new technology with very old materials.

## Acknowledgement

A part of this work was supported by Golden Amber Company. The authors appreciate their contribution of amber materials and knowledge.

## REFERENCES

1. Bilingual Newsletter of The International Amber Association. Bursztynisko, no. 33, 2011, pp. 1-44.
2. Buddhue, J.D. Some new carbon minerals kansa-site described. *The Mineralogist*, 6(1), 7-8, 1938, pp. 20-21.
3. *The Treasures of Gdańsk Amber*. City Promotion Department, Gdańsk, Poland, 2010 pp. 15-28.