

KAZIMIERZ STOIŃSKI ¹, MAREK PŁONKA ¹, JANINA ŚWIĄTEK ^{1*}

DYNAMICS OF LARGE DIAMETER HYDRAULIC LEGS UNDER APPLIED TEST METHODS

The dynamic characteristics of the hydraulic leg are essential for determining the safe working range of roof supports operating in seams threatened by rock mass tremors. The systematic increase in the support of the hydraulic legs due to deteriorating geological-mining conditions has increased their diameters, which currently exceed 0.32 m for the 1st hydraulic stage. Evaluation of the dynamic properties of the roof support and the hydraulic legs are carried out by the Central Mining Institute through calculation methods as an implementation of the Regulation of the Minister of Energy on occupational safety and health. However, the issue of validating the calculations concerning natural scale studies still needs to be addressed. There are significant limitations in this area due to the technical and metrological capabilities of the testing stations. This paper presents an attempt to evaluate bench testing of a hydraulic leg with 0.32 m of the 1st hydraulic stage diameter for the validation of computational and test methods. Results of previous studies affecting the evaluation of the research methods used are also cited. According to the authors, the optimal and economically justifiable direction is to undertake model tests using numerical analyses and to validate these results, based on the study of models of hydraulic legs that are in use at a reduced scale. The construction of testing stations to ensure adequate dynamic loading for the support of the largest diameter hydraulic legs is currently not economically viable. The problem presented, however, is important given the constantly deteriorating geological-mining conditions and the associated threat of rock mass tremors.

Keywords: hydraulic leg; dynamic characteristics; roof support; large diameters

1. Introduction

In Poland, the Upper Silesian Coal Basin has a high risk of seismic activity [4,8]. In 2019, the mining output from seams at risk of rock bursts reached 54.2% [22]. Taking into account the fact that the classification of a deposit in a particular degree of rock burst hazard is not a determinant of the occurrence of tremor, it can be estimated that currently, in the conditions of

¹ CENTRAL MINING INSTITUTE (GIG), 1 GWARKÓW SQ., 40-166 KATOWICE, POLAND

* Corresponding author: jswiatek@gig.eu

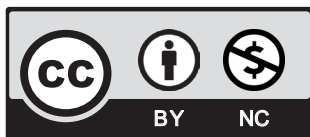

© 2022. The Author(s). This is an open-access article distributed under the terms of the Creative Commons Attribution-NonCommercial License (CC BY-NC 4.0, <https://creativecommons.org/licenses/by-nc/4.0/deed.en>) which permits the use, redistribution of the material in any medium or format, transforming and building upon the material, provided that the article is properly cited, the use is noncommercial, and no modifications or adaptations are made.

USCB, over 60% of the exploitation is carried out in the conditions of tremor hazard. Between 2008 and 2019, a total of 15,142 tremors with values of the order of 10^5 - 10^9 J were recorded [22], the quantitative distribution of which is shown in Fig. 1.

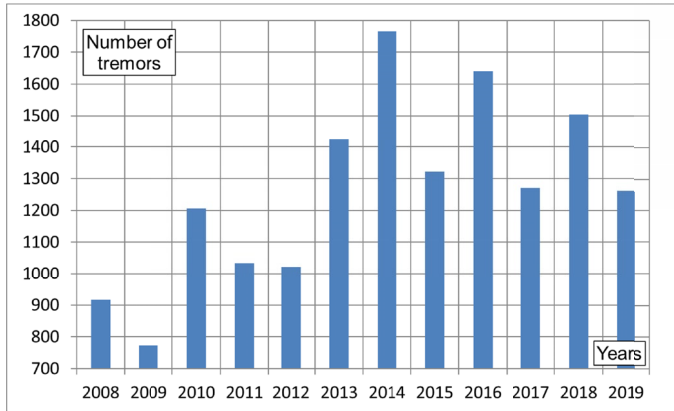

Fig. 1. Quantitative distribution of recorded tremors in USCB from 2008 to 2019 (tremor energies in the order of 10^5 - 10^9 J)

In compliance with the Regulation of the Minister on Occupational Safety and Health [14], all powered roof supports put into service in tremor prone conditions should be yielded – adapted to take over dynamic loads due to tremors. It is assumed that the dynamic impact is the result of a high-value mass impact from a very low height [8]. The yielding assessment is prepared by the Central Mining Institute (GIG) using its method. The Institute is currently the only facility on the Polish market that conducts such assessments. The yielding method is an analytical method using the principles of disturbed rock mass according to A. Biliński [1,2] and a mathematical model of a flat section with one degree of freedom and focused physical constants [17-19].

The assessment is based on documentation supplied by the client, including geological-mining conditions of the analysed longwall field (they allow to determine the expected danger of rock mass tremors), technical and operational documentation of the powered roof support, and safety devices of the hydraulic leg preventing overloading. The assessment assumes that the hydraulic leg is a fundamental element in determining the supportability, dynamics, and safety of the roof support.

Verification (validation) of the results of the yielding assessment is more often performed by testing the analysed hydraulic leg on a suitably prepared laboratory testing station. Such tests are not derived from standards and are carried out according to the procedures of in-house accredited laboratories.

The introduction onto the market and into service of roof supports with hydraulic legs of increasingly larger diameters of 1st hydraulic stage cylinders (≥ 0.32 m) has fundamentally limited the possibilities of testing these hydraulic legs to assess their dynamic properties, concerning the assessment of the yielding. These limitations are mainly due to the inability to generate a dynamic load on the hydraulic leg that coincides with the existing loads in natural conditions (in situ) [3,5-7,16,20].

This publication aims to present the differences occurring in the results of tests on large-diameter 1st hydraulic stage hydraulic legs that have been carried out using different methods, as well as to propose a solution to the problem associated with the lowest cost. The paper additionally refers to previously conducted laboratory tests of 0.2 m diameter of 1st hydraulic stage where the weight of the impact mass was close to the working support of the hydraulic leg.

2. Example of a powered roof support used in the load assessment of a hydraulic leg

The problem of evaluating the operation of a large-diameter, 1st stage hydraulic legs is presented using the example of shield support equipped with two hydraulic legs, with direct, adjacent control hydraulics. The geometric height of the roof support ranges from 2.0 to 4.1 m. The support is equipped with a two-telescopic hydraulic leg with a bottom valve, with the diameter of the cylinders of the first and second hydraulic stages of 0.32 m and 0.23 m, respectively. The initial support of the hydraulic leg is 2.01 MN, and the working support is 3.056 MN. The fluid from the sub-piston space of the hydraulic leg is led outside through three bores in the shell of the first stage cylinder. For laboratory testing, the hydraulic leg was equipped with an additional connection to measure the pressure in the sub-piston space and to connect an auxiliary hydraulic valve directly to the sub-piston space. The tested support is protected by a hydraulic system with a capacity of $Q = 650 \text{ dm}^3 \cdot \text{min}^{-1}$. A schematic diagram of the support with the hydraulic leg used is shown in Fig. 2, and Fig. 3 shows a schematic diagram of the hydraulic leg control hydraulics used.

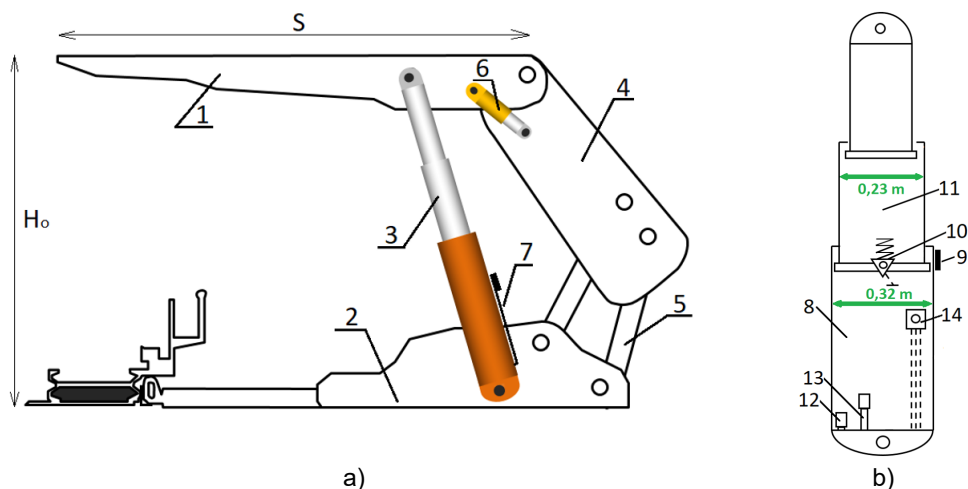

Fig. 2. Schematic diagram of the section (a) and the hydraulic leg (b); 1 – canopy; 2 – floor base; 3 – hydraulic leg; 4 – shield support; 5 – lemniscate link; 6 – canopy’s support; 7 – hydraulic leg control system; 8 – 1st stage cylinder; 9 – connection for the discharge of fluid from the 1st and 2nd stage of the space above the piston; 10 – bottom valve; 11 – 2nd stage cylinder; 12 – connection for pressure transducer in sub-piston space; 13 – short connection for the connection of an additional valve in the sub-piston space; 14 – fluid outlet connection from the sub-piston space of the hydraulic leg using boreholes in the shell of the 1st stage cylinder; H_0 – section height; S – canopy length

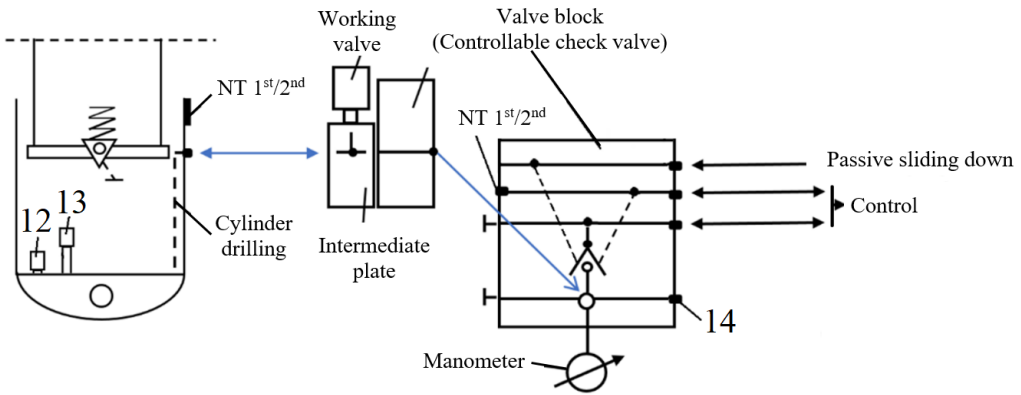

Fig. 3. Schematic diagram of the hydraulic leg control system of a unit; 12; 13 and 14, description as shown in Fig. 2; NT 1st/2nd – over-piston chamber first and second stage

The tested powered roof support was used in a 230 m long and 3.6 m high longwall surrounded by coal seam on both sides, with the roof directed towards the caving process. The coal seam in the area of the conducted longwall was inclined to an angle of 10° and deposited at the average depth of approximately 1150 m. The uniaxial compression strength of the coal seam was 22.9 MPa, while that of the roof and floor rock was 51.5 MPa and 38.3 MPa, respectively. According to the GIG methodology [10,13,15,18,19], the presented powered roof support was correctly selected for the roof conditions of the analysed longwall, taking into account the forecasted maximum rock mass tremor energy of $7 \cdot 10^6$ and the support loading factor $n_{tz} = 1.18$ [9-11].

The n_{tz} load factor for caving exploitation, according to the GIG method, is determined from the following formula [1]:

$$n_{tz} = 1 + \frac{n_{zr}}{0,04 \cdot \left(\frac{H_t}{E_t}\right)^{0,7} + 0,04 \cdot H_t + 0,5} \quad (1)$$

where: n_{zr} – coefficient depending on the method of exploitation, taking into account the value of 0.3-1.0 (dimensionless); H_t – a vertical distance of the center of the layer being the probable source of the tremor, from the roof of the excavated workings, m; E_t – predicted rock mass tremor energy, MJ.

Due to the occurrence of an excessive amount of damage to control hydraulic elements, during the run of the longwall in which the analysed support was used, an attempt was made to identify the causes of this damage. The research included the available testing options, i.e. the GIG method for the assessment of the yielding, a testing station for dynamic hydraulic leg loading using a mass impact (GIG's station), and a testing station for dynamic hydraulic leg loading using an explosive (ITG KOMAG's station).

Tests carried out on a 0.32 m diameter hydraulic leg and its overload protection system made it possible to determine the degree of effectiveness of the protections applied. They also made it possible to assess the utility of particular test methods for making such assessments concerning large-diameter hydraulic legs. A significant difficulty in the assessment carried out is the lack of

measurements of several physical quantities useful for an accurate description of the hydraulic leg dynamics (not realised in the tests), which moreover should be carried out with a sufficiently high frequency during the tests or operation of the hydraulic legs. This situation leads to a limitation to pressure measurements as a function of time for the cases analysed. With such a limited range of measurement of physical quantities, the authors attempted to use the analysis of the following physical quantities to evaluate the dynamics of the hydraulic leg with its safety system:

- momentum (characterising the intensity of load propagation of the tested hydraulic leg),
- the rate of build-up of fluid pressure in the hydraulic leg protection system (assessment of the possibility of limiting pressures due to time constants of the protection elements),
- period of oscillation of the system (determination of the time-dependent course of the function).

3. Description and scope of the tests

The study covered a powered roof support equipped with a hydraulic leg system as shown in Figure 2, fitted with the control system shown schematically in Fig. 3. The work of the support was studied analytically following the GIG's yielding method. The hydraulic leg itself was subjected to bench tests under dynamic loading using a mass impact and an explosive. The scope of individual laboratory tests of the hydraulic leg was adapted to the technical and metrological capabilities of the test hydraulic legs, which had a significant impact on the results obtained and their subsequent evaluation. The fluid pressure in the hydraulic leg was measured and recorded with a Hottinger apparatus with a sampling frequency of 9.6 kHz. The hydraulic leg was tested in a system with and without a pressure limiting hydraulic valve. The initial supply pressure was 15 MPa for the mass impact test and 30 MPa for the explosives. The different supply pressures were due to the technical capabilities of the testing stations [21].

3.1. Analytical determination of the dynamic load of the support according to the GIG's method

The dynamic load acting on the support due to a rock mass tremor is determined analytically according to the GIG's yielding method. The method is used to calculate the load course of the hydraulic leg (loading force) as a function of time, based on the model of the rock mass disturbed using the method developed by A. Biliński and a flat model of a section with concentrated constants and one degree of freedom [1,2,?](Prusek, Rajwa, Stoiński 1998). The course of the predicted load on the support's hydraulic leg is calculated, based on the adopted model, from the following formula:

$$f(t) = \frac{1}{\cos(90 - \alpha)} \left(F_w + F_d \left(1 + k_d e^{-\delta t} \sin(\omega t - \varphi) \right) \right) \quad (2)$$

where: f – the momentary value of the energy in the hydraulic leg; F_w – hydraulic leg's initial bearing capacity, N; F_d – force dynamically loading the hydraulic leg ($F_d = n_{tz} \cdot F_r - F_w$), N; F_w – working bearing capacity of the hydraulic leg, N; k_d – calculation factor; t – time, s; α – the angle of inclination of the hydraulic leg concerning the floor base, °; δ – damping factor of the system, s^{-1} ; φ – the angle of displacement of the course of the force in the hydraulic leg for the loading force, rad; ω – pulsation of the vibrating system, s^{-1} .

Calculations of the course of the loading force on the analysed two-telescopic hydraulic leg with a bottom valve of the 1st stage diameter equal to 0.32 m (for data: $F_w/F_r = 2.01/3.056$ MN, $n_{iz} = 1.18$, $H_o = 3.6$ m) and the designated safe working range of the support according to the GIG method are shown in Fig. 4.

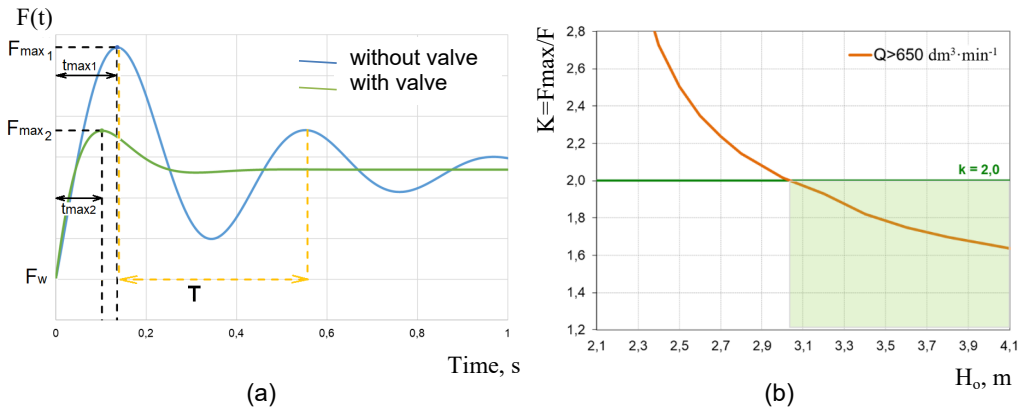

Fig. 4. The calculated course of the momentary values of the hydraulic leg loading force as a function of time (a) and the determined safe working range of the support (b); where T – the period of oscillation of the system without the valve, s; F_w – initial force, N; F_{max1} , F_{max2} – maximum force: without the valve, with valve, N respectively; F_N – nominal force (greatest working value); Q – the capacity of the hydraulic leg safety system, $\text{dm}^3 \cdot \text{s}^{-1}$; H_o – the working height of support, m; t_{max1} , t_{max2} – force build-up times respectively: without the valve, with valve

The time-frequency variation of the hydraulic leg force for the case of a safety system without a pressure limiting valve has the character of a damped sinusoid with an oscillation period of approximately $T \approx 400$ ms. By connecting a hydraulic valve to the protection system, the course of the force loading the hydraulic leg is aperiodic, with a smaller vibration amplitude and a shorter course (Fig. 4a).

The determined safe working height range of the support, for the case under consideration, largely limits its safe operation at low working heights, despite the use of pressure limiting valves in the hydraulic leg (Fig. 4b). This is largely due to the significant inclination of the hydraulic leg relative to the canopy, which consequently affects the poor geometry of the support and the hydraulic leg operation (no minimum fluid column under the 1st stage piston).

3.2. Determination of dynamic loads on a hydraulic leg using a mass impact

Testing of the hydraulic leg was carried out at the drop-weight testing station located at GIG. Fig. 5 shows the mass impact testing station and an example of the recorded pressure waveform in the hydraulic leg, with the hydraulic valve connected directly to the working space of the hydraulic leg (connection No. 12 according to Fig. 2b). Fig. 6 shows the recorded pressure waveform for the case of connecting the valve to the connection leading the fluid out of the

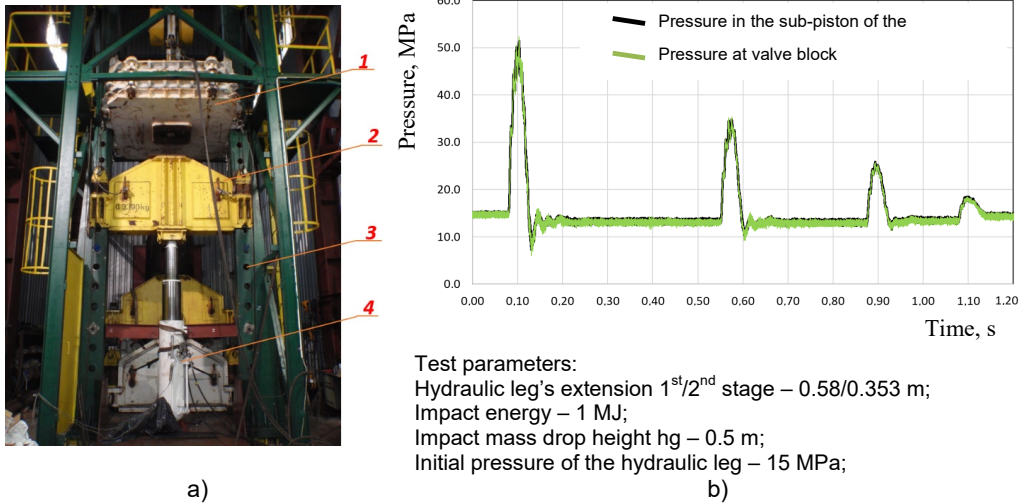

Fig. 5. Mass impact testing station (a) and an example of the recorded liquid pressure waveform in the hydraulic leg (b); 1 – impact mass 20 Mg; 2 – traverse 3.3 Mg; 3 – guides for impact mass and traverse; 4 – tested hydraulic leg

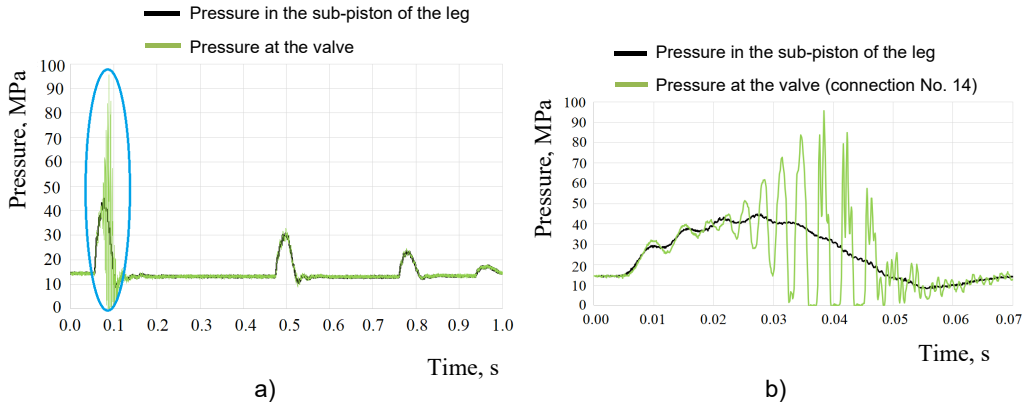

Fig. 6. Pressure waveform in the hydraulic leg, 0.32 m 1st diameter, loaded with a mass impactor (a) and the first recorded pressure peak (b). Test conditions: (impact energy $E_u = 0.8$ MJ, impact mass drop height $h_g = 0.4$ m; hydraulic valve SP12 connected to connection No. 14 according to Fig. 2b; initial hydraulic leg pressure 15 MPa)

hydraulic leg's working space with drilled holes in the shell of the 1st stage cylinder (connection no. 14 according to Fig. 2b) [21].

Loading the hydraulic leg with the impact of a freely falling mass causes it to bounce off the hydraulic leg several times until the waveform dampens (Fig. 6). The duration of the first waveform (the first largest pressure peak) taken as half the system vibration period ($T/2$) was estimated to be 40 ms. Connecting the valve to port No. 14 – Fig. 2b (drilling into the cylinder

shell) does not significantly affect the pressure value in the sub-piston space. However, there are pressure pulsations in the protection system with maximum values of about 90.0 MPa, more than twice the pressure in the sub-piston space. The pulsation frequency is approximately 300 Hz.

3.3. Determination of the load pattern of a hydraulic leg using an explosive

The study was conducted at the ITG KOMAG testing station in Gliwice. Fig. 7 shows the test hydraulic leg and an example of recorded pressure waveform for the case of connecting the valve directly to the working space of the hydraulic leg connection No. 12 according to Fig. 2b. Fig. 8 shows the recorded pressure waveform for the case of connecting the valve to the connection leading the fluid out of the hydraulic leg working space with drilled holes in the shell of the 1st stage cylinder (connection no. 14 according to Fig. 2b) [21].

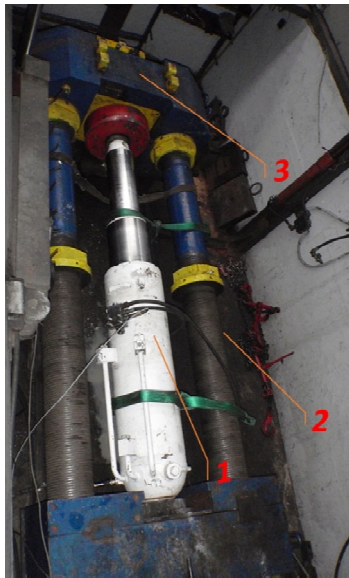

a)

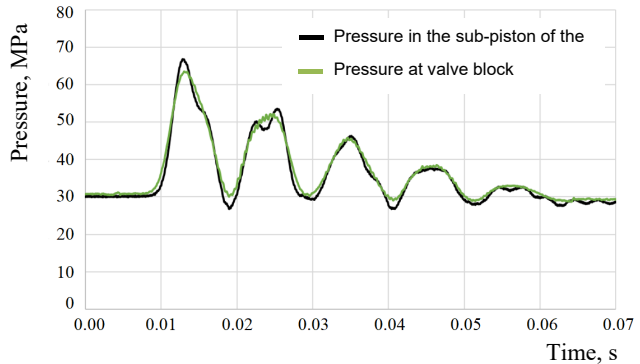

Test parameters:

Hydraulic leg's extension 1st/2nd stage – 0.30/0.65 m;

Explosive used: oak 300g and cherry 5g;

Initial pressure of the hydraulic leg – 30.0 MPa;

b)

Fig. 7. Testing station at ITG KOMAG (a) and an example of the recorded course of fluid pressure in the hydraulic leg as a function of time (b); 1 – tested hydraulic leg; 2 – guiding screws; 3 – load generator

The recorded pressure waveform shown in Fig. 8 is a damped sinusoid with a period of oscillation of approximately $T \approx 12$ ms. The recorded pressure in the sub-piston space and the hydraulic leg block has a similar pattern, and there are no pressure pulsations in the system causing the system to excite. The connection of valve SP12 to port No. 14 (Fig. 2b) using boreholes in the cylinder shell resulted in pressure pulsations in the hydraulic leg protection system (Fig. 8a) with an amplitude significantly higher compared to runs without the valve (Fig. 7). The connection of valve SP14 did not affect the limitation of maximum pressures in the working space of

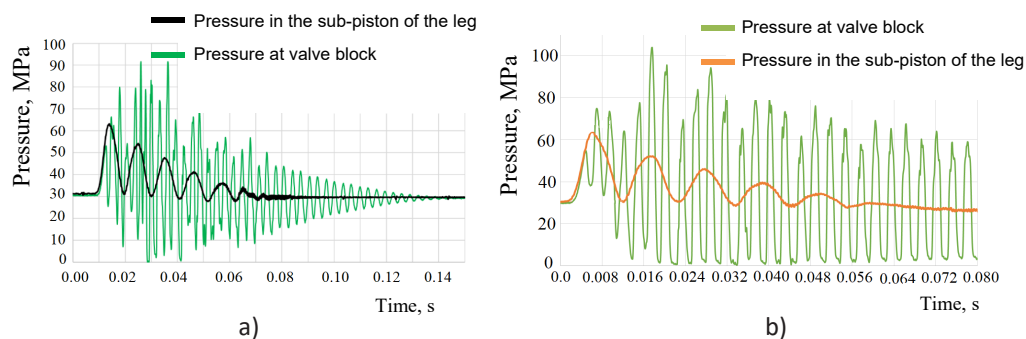

Fig. 8. Pressure waveform in a dynamically loaded hydraulic leg using explosive (a) and the case of resonant vibrations of the control system (b) for test parameters: supply pressure 30 MPa, hydraulic leg extension 1st/2nd stage – 0.30/0.65 m, explosive material type: oak 300 g, cherry 5 g; where a) valve SP12 in connection No 14, b) valve SP14 in connection No. 13, valve SP7 in connection No. 14 as per Fig. 2b

the hydraulic leg. The connection of the valve SP14 to port13 and valve SP7 to port 14 resulted in the occurrence of self-resonant vibrations, with a duration exceeding that of the hydraulic leg load (Fig. 8b).

4. Analysis of the results

The results of dynamic tests on a hydraulic leg depend on its dynamic characteristics, including the specified load as a function of time. Each test method, whether analytical or stationary, has a characteristic loading pattern. This results in different test results, often impossible to compare with each other. Particularly significant differences in results are observed in cases where the dynamics of hydraulic legs with large first-degree diameters (≥ 0.32 m) are studied. The above problem is presented in the example of tests on a two-telescopic hydraulic leg with a bottom valve of 0.32 m 1st-degree diameter tested with the analytical, mass impact and explosive methods.

According to GIG's analytical method, the determined waveforms have the character of a periodic sinusoid damped when a hydraulic pressure limiting valve is not used in the system. This character is due to the participation of a very large mass in the system under consideration, the weight of which is close to the support of the hydraulic leg. The connection of a hydraulic valve to the hydraulic leg protection system causes the waveform to change from periodic to aperiodic (Fig. 4a).

Concerning the results of the mass impact test, there is the case of an impact mass with a weight significantly less than the support of the hydraulic leg, while this mass loads the test hydraulic leg at high speed. In this case, the impact mass rebounds and the hydraulic leg is dynamically loaded again until the waveform is suppressed (Fig. 5a). Additionally, during testing of the hydraulic leg, vibrations were found in its protection system (see Fig. 6), which do not affect the course of pressure in the space under the hydraulic leg, but pose a threat to the safety of operation of the control system (vibrations of the order of 90 MPa, vibration frequency of several hundred hertz). The likely reason for this is the large volume of fluid under very high pressure contained in the hydraulic leg (there are more than 100 dm³ of fluid in a hydraulic leg

with a 0.32 m 1st stage diameter). An attempt is made to limit this pressure through a hydraulic valve connected to the hydraulic leg protection system with a connection pipe that is too long (in the case under consideration, by drilling into the shell of the 1st cylinder). In the conducted tests, no significant effect of the hydraulic valve actuation on the pressure limitation in the cone sub-piston space was found.

In the case of the explosive method, the waveforms have the character of free vibrations of the hydraulic leg (no external mass contribution). Here, too, it was observed that the activation of the hydraulic valve did not significantly affect the pressure limitation in the cone sub-piston space (Fig. 8). However, frequent cases of excitation of the system were recorded, as well as a case that can be described as resonant vibration of the system, with its frequency (Fig. 8). The excitation duration exceeded the hydraulic leg load duration.

The comparative analysis of the tests carried out with the above-mentioned methods was limited to half of the vibration period of the system (from 0 to $T/2$), which is important for the understanding of the phenomenon. Fig. 9 shows a selection of the recorded waveforms of each test used for comparative analysis.

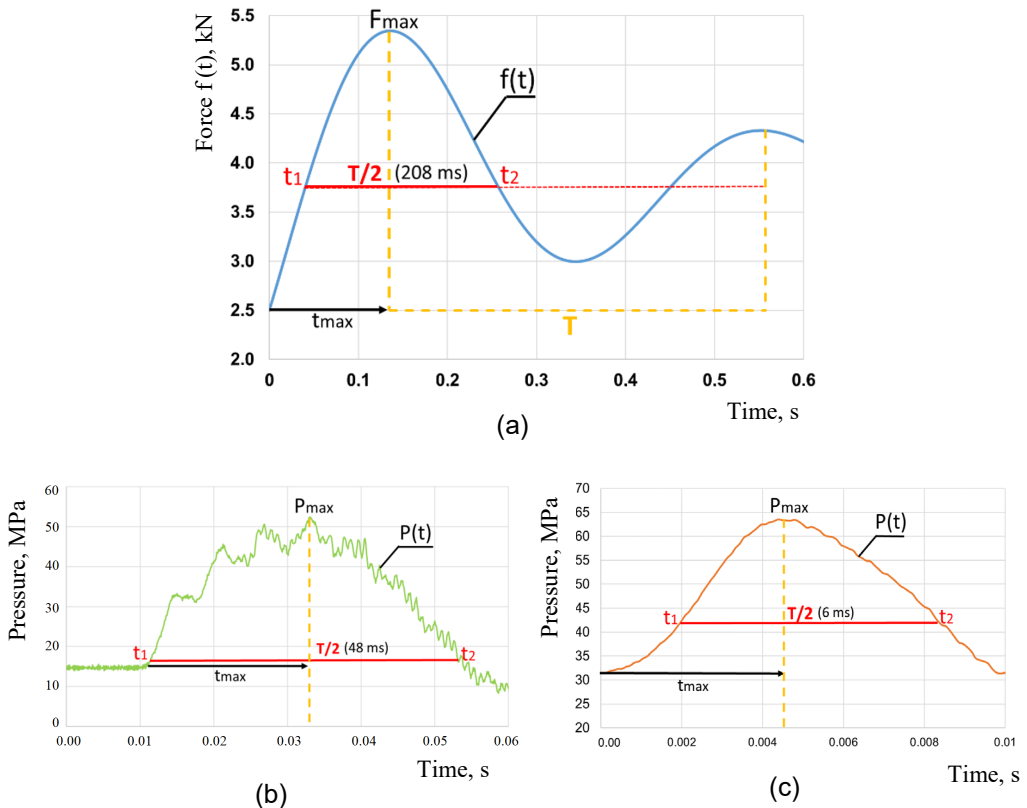

Fig. 9. Time course of the recorded force or pressure for the hydraulic leg with a 1st stage diameter of 0.32 m for the range from 0 to $T/2$; a) characteristics obtained by calculation according to the GIG yielding method; b) characteristics obtained by mass impact testing; c) characteristics obtained by explosive testing

For the cases shown in Fig. 9, the calculated and test-derived: system vibration periods, force drive and system pressure build-up velocities are compared. The force propulsion was calculated from the relation:

$$I = \int_{t_1}^{t_2} f(t) dt, \text{ Ns} \quad (3)$$

$$I = S_z \int_{t_1}^{t_2} p(t) dt, \text{ Ns} \quad (4)$$

where: S_z – cross-sectional area of the 1st stage of the hydraulic leg, m²; t_1, t_2 – start time and end time of the run, s; f – force, N; p – pressure, Pa.

The oscillation period of the system T and the pulsation ω were calculated from the relation:

$$T = \frac{2\pi}{\omega}, \text{ s} \quad (5)$$

$$\omega = \sqrt{\frac{ks}{m}}, \text{ s}^{-1} \quad (6)$$

where: k_s – hydraulic leg equivalent stiffness, Nm⁻¹; m – system mass, kg.

The fluid pressure build-up velocity V_c in the 1st stage of the hydraulic leg was calculated as the mean value from the relation:

$$V_c = (P_{\max} - P_w)/t_{\max}, \text{ Pa} \cdot \text{s}^{-1} \quad (7)$$

where: P_{\max} – maximum fluid pressure, Pa; P_w – initial pressure, Pa; t_{\max} – the time taken for the pressure to reach its maximum value, s.

The results of the tests and calculations carried out are included in Table 1. They concern the analysed dynamic waveforms in the range 0 to $T/2$.

TABLE 1

Summary of test results and calculations of the analysed dynamic waveforms for a hydraulic leg of the 1st stage diameter of 0.32 m

Type of the test	Fig.	Extension of the hydraulic leg [m]	F_{\max} Acc.to calculations [MN]	Acc. to tests [MPa]	$T/2$ Acc. to calculations [ms]	$T/2$ Acc. to tests [ms]	Force impulse I , [Ns] × 10 ³	V_c [MPa · s ⁻¹]
1	2	3	4	5	6	7	8	9
Calculation according to the GIG's method	9a	0.58/0.53	5.3	68*	208	—	196	300
Mass impact	9b	0.58/0.53	—	51.5	53	48	78	1600
An explosive	9c	0.30/0.65	—	63.5	6.5	6	14	7000

* Note: – calculated value

The following conclusions can be drawn from the data collected in Table 1:

- there is a high correspondence between the calculated and test-determined values of the vibration periods for the individual test types,
- there are large differences in the force impulse values calculated for the different types of tests when evaluating the same hydraulic leg (column 8, Table 1 – $196/78/14 \times 10^3 \text{ N} \cdot \text{s}$),
- there are large differences in the values of the rate of pressure build-up for different types of tests, for the same hydraulic leg (column 9, Table 1 – $300/1600/7000 \text{ MPa} \cdot \text{s}^{-1}$).

The high values of the velocity of pressure build-up in the hydraulic system under analysis (in which the working medium is a fluid), and their significant differences for the different types of tests, put into consideration the validity of adopting a constant value of the compressibility of the fluid and its influence on the correctness of the work of the pressure limiting systems in the hydraulic leg.

5. Testing a 0.2 m diameter hydraulic leg and analysis of the results

To enrich the issue under consideration, a case study of a single-telescope hydraulic leg with a cylinder diameter of 0.2 m at the Aviation Institute in Novosibirsk (Russia) using a drop-weight testing station with an impact mass of 100 Mg is additionally cited. A series of tests of a single-telescope hydraulic leg with a cylinder diameter of 0.2 m were carried out on the above-mentioned device with different initial supports, as well as valves limiting the pressure in the working space of the hydraulic leg [?](Report 1994). The test method was similar to that shown in Fig. 5 of this publication. During the tests, the hydraulic leg loading force, the fluid

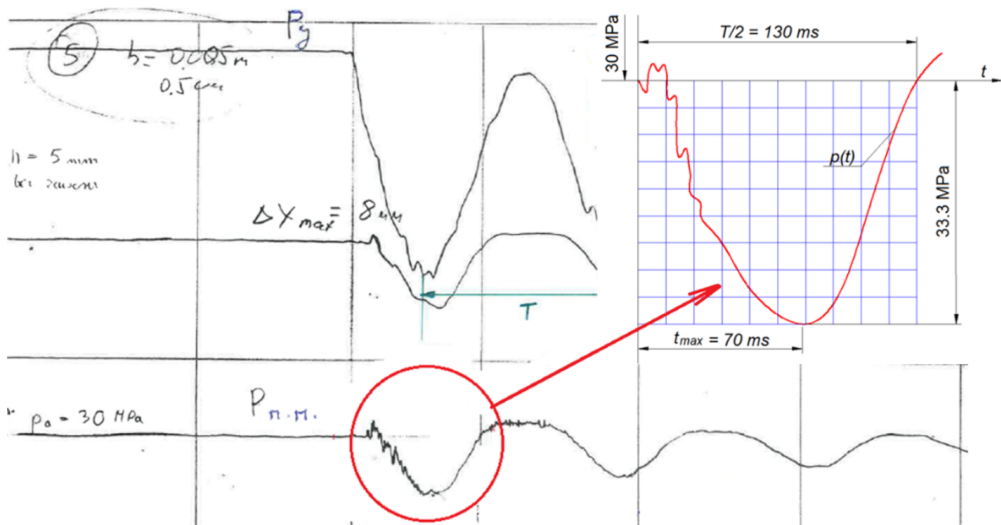

Fig. 10. Recorded pressure waveform in a $\varnothing 0.2 \text{ m}$ hydraulic leg without the valve, loaded with 100 Mg mass impact [?](Report 1994)

pressure in the hydraulic leg working space and the displacement of the hydraulic leg piston were measured and recorded. For this publication, the recorded hydraulic leg load force, fluid pressure and hydraulic leg piston slide were used in test 5. The test parameters were as follows: hydraulic leg supply pressure 30 MPa, impact mass 100 Mg; impact mass drop height 0.005 m; hydraulic leg extension 0.56 m; without pressure limiting valve.

Fig. 10 shows the recorded test waveforms, supplemented by a recording from 0 to $T/2$. According to the test parameters, the hydraulic leg was loaded with an impact mass of 100 Mg (weight of the impact mass close to the support of the hydraulic leg). Using the calculation relations used in the GIG method for the assessment of yielding, the pressure waveform as a function of time $p(t)$ was determined analytically. The waveforms obtained are damped sinusoidal with an oscillation period of approximately $T \approx 270$ ms.

A comparison of the results obtained by testing and calculation is included in Table 2 according to the relations given in Chapter 4.

TABLE 2

Summary of test results and calculations for selected dynamic waveforms
of a 0.2 m diameter cylinder [?](Report 1994)

Type of the test	Fig.	F_{\max} Acc. to calculations [MN]	P_{\max} Acc. to research [MPa]	$T/2$ Acc. to calculations [ms]	$T/2$ Acc. to: research [ms]	Force impulse I , [Ns] $\times 10^3$	V_c [MPa \cdot s $^{-1}$]
Mass impact	10	1.99	63.3	130*	130	127	476

* Note: the fluid stiffness modulus B_c taken as $1.15 \cdot 10^9$ MPa (two-phase fluid)

6. Conclusions

The hydraulic leg determines the dynamics of the powered roof support. Knowing its dynamic characteristics is fundamental to determining the safe working range of powered roof supports operating in seams threatened by rock mass tremors. The systematic increase in the section support due to deteriorating geological-mining conditions has increased the diameters of the hydraulic legs – currently above 0.32 m for the 1st hydraulic stage (under the conditions of Polish mining, the largest diameters are 0.42 m). The evaluation of the dynamic properties of the support and the hydraulic leg is carried out by the Central Mining Institute using the calculation method as an implementation of the relevant Ministerial Decree on Occupational Safety and Health. In parallel, laboratory tests are being carried out to determine the dynamic characteristics of the hydraulic legs as verification of the calculations carried out. This applies in particular to the new powered roof supports being introduced, which are equipped with large-diameter hydraulic legs.

The analytical and in-situ tests presented in this publication have made it possible to study the dynamics of the support and the hydraulic leg under dynamic loads and to draw the following conclusions:

- The test results carried out computationally, with a 20 Mg and 100 Mg mass impactor, and with explosives vary considerably. Similar assessments of the hydraulic leg dynamics were obtained by computational methods and using an impact mass of 100 Mg (for a 0.2 m diameter hydraulic leg).

- The results of tests using a 20 Mg impact mass and using an explosive differ, mainly due to different loading dynamics. The listed ways of loading the hydraulic leg showed the low effectiveness of the hydraulic valves in limiting the pressure in the sub-piston space of the hydraulic leg, together with the tendency for excitations to occur in the hydraulic leg control system.
- The methodology and test conditions of the hydraulic leg control system should be compatible with the expected dynamics of its in situ operation in terms of both load values and time courses. Maintaining this assumption will allow the tests to be carried out correctly and the results to be properly evaluated.
- The technical possibilities of the currently available laboratory benches do not provide for loads corresponding to the actual loads. This applies in particular to sections equipped with large-diameter 1st stage piston hydraulic legs.
- A solution to the problem may be the use of numerical modelling.
- When numerical modelling is used, the problem of validating the results on real models remains. Validation of the results can be done by testing scaled-down models of the actual hydraulic leg.
- The numerical modelling is proposed to use the model used in the assessment of yielding according to the GIG method (flat model, with concentrated constants and one degree of freedom). However, it needs to be supplemented with relations describing the flows in the systems protecting the hydraulic leg from overloading. This is an important requirement for shields intended for use in rock mass tremor hazard conditions.
- Validation of numerical calculations using tests on scale models of the actual hydraulic legs is proposed to be carried out according to the following principles:
 - that the rate of pressure rise of the liquid in the hydraulic leg does not exceed $500 \text{ MPa} \cdot \text{s}^{-1}$,
 - the load on the hydraulic leg should not exceed the permissible values of its support,
 - the stiffness of the actual models should ensure that the drive values are similar for a given type of hydraulic leg or type of test,
 - conversion of parameter values from model to real values should be carried out using the conversion factors developed (introduction of criterion numbers).

The loading of real models specially prepared for testing on a reduced scale can be carried out using a drop-weight test at GIG. It enables a load to be generated with a mass share of between 1 and 30 Mg. The proposal to combine model tests using numerical methods supplemented with tests of real models on a reduced scale is feasible at a low cost. Their implementation would significantly increase the possibilities of cognitive research, design optimiation, and assessment of the operation of the support and its elements in rock mass tremor hazard conditions.

References

- [1] A. Biliński Method of selection of longwall face and roadway supports for the panelling conditions (in Polish). Prace naukowe – Monografie CMG KOMAG. Gliwice (2005).
- [2] A. Biliński, T. Kostyk, S. Prusek, Rules for the selection of powered support for longwall workings (in Polish). Bezpieczeństwo Pracy i Ochrona Środowiska w Górnictwie **3**, 14-17 (1997).
- [3] Gwiazda J.B., Mining hydraulic support resistant to rock bursts (in Polish). Katowice, Wydawnictwo Śląsk (1997).

- [4] T. Janoszek, The assessment of longwall working stability based on the Mohr-Coulomb stress criterion – numerical analysis. *Archives of Mining Sciences* **65**, 3, 493-509 (2020).
- [5] V.I. Klishin T.M. Tarasik, Stand tests of hydraulic props in dynamic loads. *Journal of Mining Science* **37**, 1, 77-84 (2001).
- [6] L.C. Liang, J.J. Tian, H. Zheng, S.J. Jiao, A study on force transmission in a hydraulic support under impact loading on its canopy beam. *Journal of the China Coal Society* **40**, 11, 2522-2527 (2015).
- [7] X.K. Liu, Z.H. Zhao, R. Zhao, Study on dynamic features of leg applied to hydraulic powered support under bumping load. *Coal Science and Technology* **40**, 12, 66-70 (2012).
- [8] W. Masny, Powered support in dynamic load conditions – numerical analysis. *Archives of Mining Sciences* **65**, 3, 453-468 (2020).
- [9] S. Prusek, S. Rajwa, A. Wrana, A. Krzemień, Assessment of roof fall risk in longwall coal mines. *International Journal of Mining, Reclamation, and Environment* 1-17 (2016).
- [10] S. Prusek, S. Rajwa, A. Walentek, W. Masny, Powered support selection for longwall workings in dynamic load conditions, “3rd International Symposium on Mine Safety Science and Engineering, Montreal” 13-19, (2016).
- [11] S. Prusek, M. Płonka, A. Walentek, Applying the ground reaction curve concept to the assessment of shield support performance in longwall faces. *Arab. J. Geosci.* **9**, 3, 1-15 (2016).
- [12] S. Prusek, S. Rajwa, K. Stoiński, Kriterien zur Abschätzung des Risikos von Strebschaden, *Glückauf-Forschungshefte* **11**, 92-95 (2005).
- [13] S. Rajwa, S. Prusek, K. Stoiński, Description of the method of yielding a shield support (in Polish). *Bezpieczeństwo Pracy i Ochrona Środowiska w Górnictwie* **12**, 3-8 (2016).
- [14] Regulation of the Minister of Energy of November 23, 2016, *Journal Of Laws* No. 2017, item 1118 § 523 sec. 1, point 1 (in Polish).
- [15] S. Rajwa, W. Masny, A. Wrana, A comprehensive method for the selection of powered roof support in conditions of the rockburst hazard. *Wiadomości Górnicze* **1**, 2-7 (2017).
- [16] G. Shein, Dynamic loads of a powered longwall support (in Polish). *Maszyny Górnicze* **92**, 5-10 (2002).
- [17] K. Stoiński, Selection of hydraulic prop of longwall support for work in conditions of rock mass tremors hazard. *Archives of Mining Sciences* **43**, 3, 471-486 (1998).
- [18] K. Stoiński, Mining supports in conditions of rock mass tremors hazard (in Polish). Wyd. GIG, Katowice 2000.
- [19] K. Stoiński at al., Mechanized longwall supports for rock tremors hazard conditions (in Polish). Wyd. GIG, Katowice, 2018.
- [20] S. Szweda, Identification of parameters characterizing the load of the powered support section due to the dynamic influence of the rock mass (in Polish). *Zeszyty Naukowe Politechniki Śląskiej. Seria Górnictwo* 259 (2004).
- [21] J. Świątek, The method to improve the operation of the hydraulic leg of a powered roof support (in Polish). PhD thesis, GIG Katowice (unpublished) (2020).
- [22] Annual report on the state of basic natural and technical hazards in hard coal mining 2019 (in Polish). Praca pod kierunkiem J. Kabiesz. Wyd. GIG, 2019.