

Effect of the Carbides and Matrix on the Wear Resistance of Nodular Cast Iron

G. Gumienny

Department of Materials Engineering and Production Systems, Lodz University of Technology,
Stefanowskiego 1/15 Street, 90-924, Łódź, Poland

Corresponding author. E-mail address: grzegorz.gumienny@p.lodz.pl

Received 29.05.2013; accepted in revised form 04.06.2013

Abstract

This paper presents the results of the abrasive wear resistance of selected types of nodular cast iron, including ADI, cooperating with quartz sand and 100 grit abrasive paper. It has been shown that carbides in nodular cast iron cause an increase in wear resistance of 6 to 12% depending on the surface fraction of the carbides and type of the matrix. For the same unit pressure the mass loss of the cast iron cooperating with quartz sand is many times larger than the cast iron cooperating with abrasive paper. For both abrasives the highest wear resistance showed nodular cast iron with upper and lower bainite and carbides.

Keywords: Wear resistant alloys, Carbide nodular cast iron, Wear resistance, ADI

1. Introduction

High requirements for high-quality materials engineering make it necessary to improve their mechanical and utilitarian properties. Wear resistant alloys constitute an important group among them. In the Department of Materials Technology and Production Systems of the Lodz University of Technology modern types of nodular cast iron with different matrix containing carbides were developed [1-3]. This microstructure provides high abrasive and adhesive wear resistance [4, 5]. In recent years, research of cast iron cooperating with abrasive paper or steel counterface was conducted. Wear resistance was measured by mass loss of the specimen. This methodology has been successfully used by other authors [6]. Wear resistance tests of the nodular cast iron cooperating with loose grains of the quartz sand had not yet been carried out. Therefore, the aim of this study was to investigate the wear resistance of selected types of nodular cast iron, including carbide cast iron and ADI, with the cooperation with loose grains of quartz sand. For comparison, the wear resistance of the cast iron cooperating with abrasive paper at the same unit pressure was tested.

2. Work methodology

A cast iron to study was melted in the PI30 induction furnace by Elkon with capacity of 30 kg. Nodularizing process was made with use of Inmold method. The microstructure of the pearlite, bainite and carbides was obtained by an appropriate combination of Mo, Cr, Ni and Cu. An ausferritic microstructure in ADI was obtained after austenitizing at the temperature of 900°C/1 h and austempering at 375°C/1 h. The chemical composition of the tested cast iron is presented in Table 1. Its assessment was made with using SPECTROMAXx stationary metal analyzer made by Spectro Analytical Instruments GmbH.

The surface fraction of the matrix components were examined with using NIS-Elements BR image analysis program.

Tribological tests were carried out on an experimental station, whose scheme is shown in Figure 1.

Specimens for wear resistance tests were made in the shape of the shaft with a diameter of $18.5 \cdot 10^{-6} \text{ m}^2$ and a length of $40 \cdot 10^{-6} \text{ m}^2$.

Table 1.
The chemical composition of the examined types of nodular cast iron

No	Type of cast iron metal matrix and the proportion of the components	Chemical composition, wt%						
		C	Si	Mn	Cr	Mo	Ni	Cu
1.	ausferrite 100%	3.41	2.61	0.30	–	–	–	0.48
2.	pearlite 100%	3.83	2.42	0.37	–	–	0.93	1.44
3.	pearlite 90%, carbides 10%	3.88	2.23	0.40	0.99	–	0.96	1.55
4.	upper bainite 100%	3.80	1.93	0.05	–	1.37	1.01	–
5.	upper bainite 95%, carbides 5%	3.30	2.27	0.08	–	2.00	1.06	–
6.	upper bainite 88%, carbides 12%	3.72	1.94	0.06	0.36	1.82	0.96	–
7.	upper bainite 65%, lower bainite 30%, carbides 5%	3.63	2.32	0.28	–	1.58	1.65	–

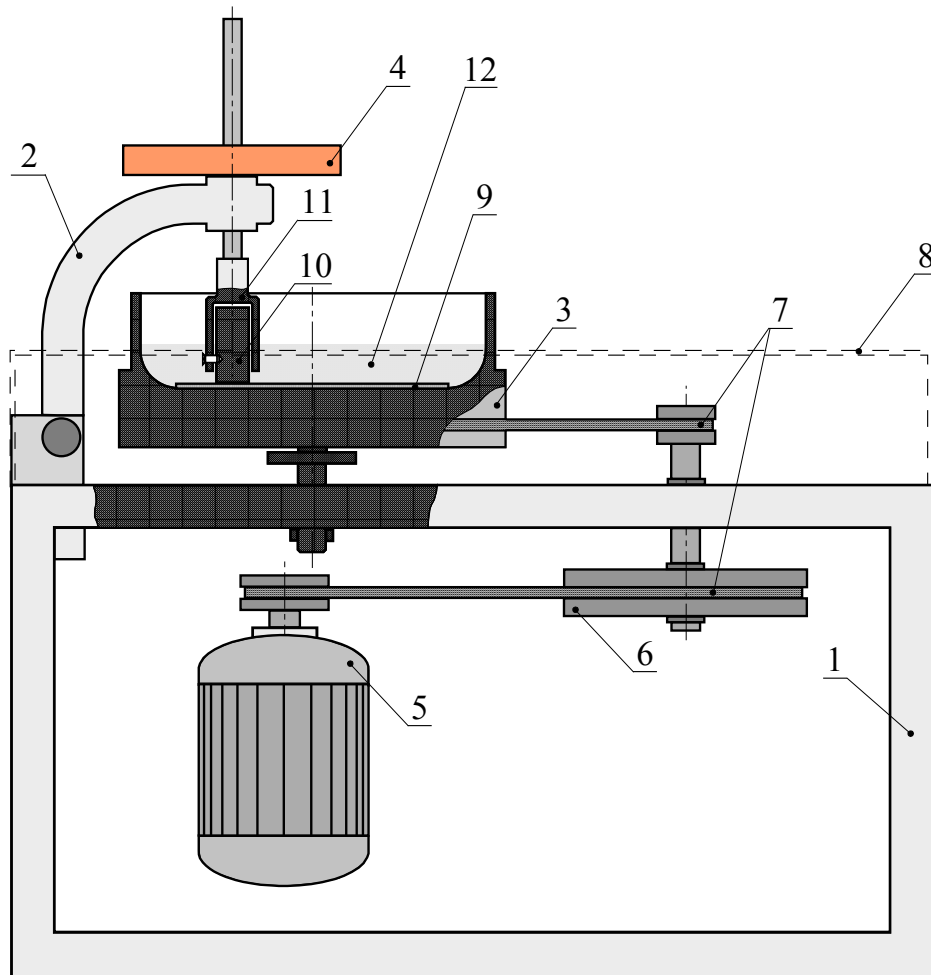

Fig. 1. The scheme of the abrasive wear testing stand: 1 – housing, 2 – mobile lever, 3 – revolving pan, 4 – load, 5 – engine, 6 – fly-wheel, 7 – driving belts, 8 – cover, 9 – abrasive paper, 10 – specimen's, 11 – specimen holder, 12 – quartz sand

The maximum concentration of P and S was 0.05% and 0.01%, respectively.

Test conditions were as follows:

- specimen's load: $F = 19,6133 \text{ N}$,
- abrasive surface of the specimen: $S = 268,8 \cdot 10^{-6} \text{ m}^2$,

- specimen's unit pressure:

$$\sigma = \frac{F}{S} = \frac{19,6133 \text{ N}}{268,8 \text{ mm}^2} = 0,073 \text{ MPa}, \quad (1)$$

- rotational speed: $\omega = 75 \text{ RPM}$.

To abrasive wear resistance tests 100 grit abrasive paper and quartz sand were used.

In order to determine the main fraction and the homogeneity index of the quartz sand a sieve analysis with using LPzE-1 electromagnetic screen was performed.

The microstructure of the cast iron was examined on nital etched metallographic specimens at a magnification of $\times 1000$ with use of Nikon Eclipse MA200 metallurgical microscope.

Specimen's mass loss was measured with using "Sartorius CP 224S-OCE" electronic balance with an accuracy of 0.0001 g (measurement error ± 0.0003 g).

3. Results

In Figure 2 (a ÷ f) the microstructure of the tested kinds of cast iron is presented.

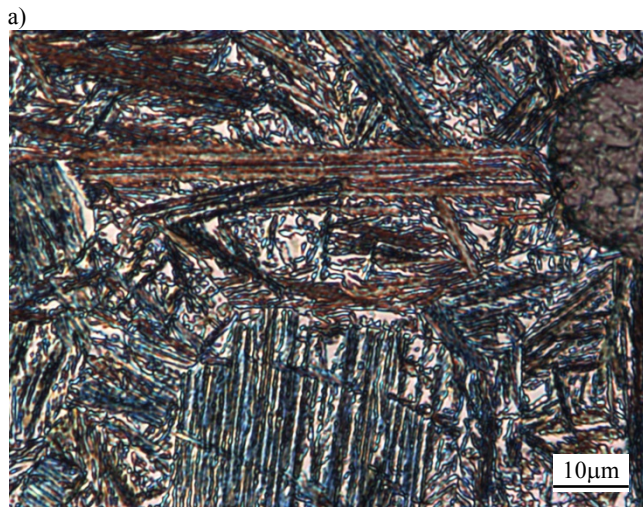

microstructure: nodular graphite, ausferrite

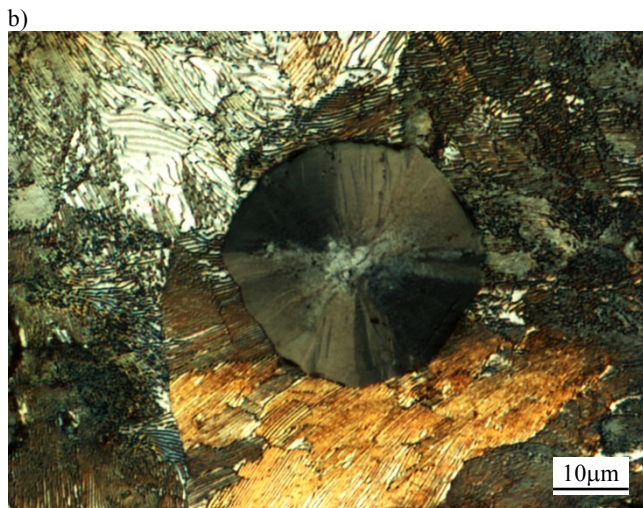

microstructure: nodular graphite, pearlite

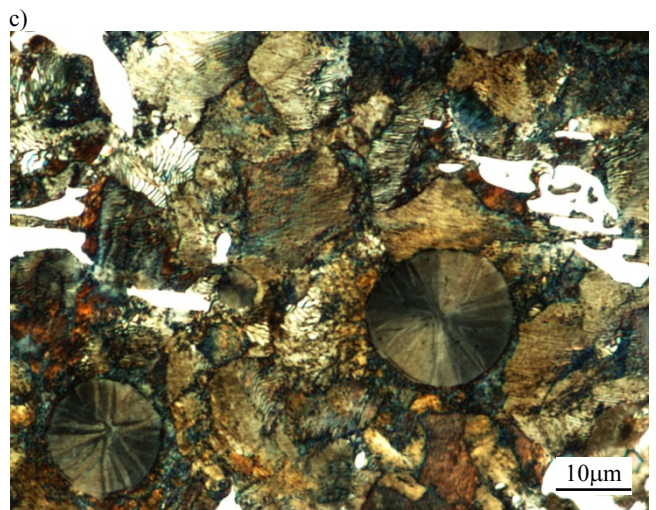

microstructure: nodular graphite, pearlite, carbides

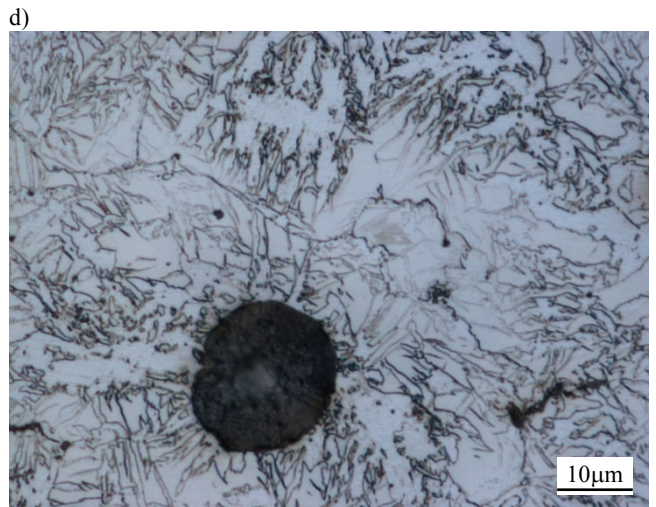

microstructure: nodular graphite, upper bainite

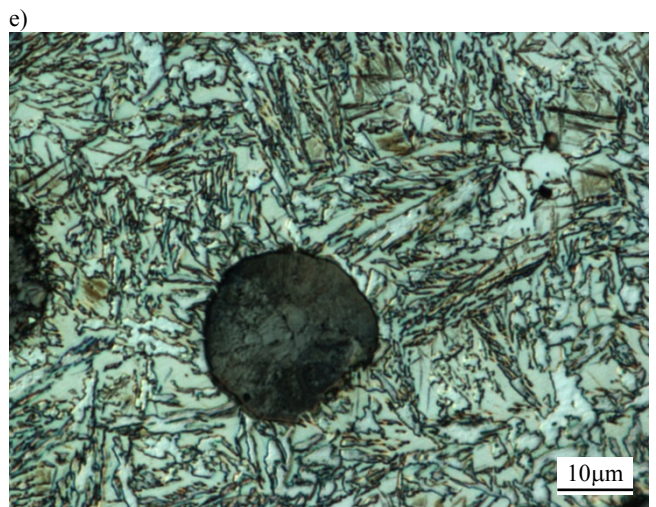

microstructure: nodular graphite, upper bainite, carbides

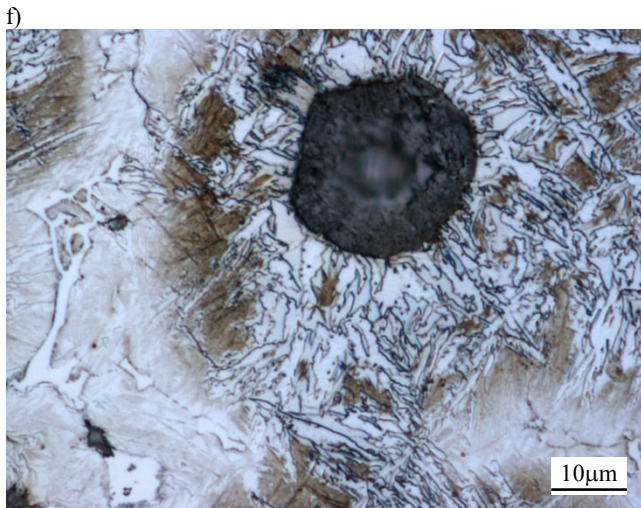

microstructure: nodular graphite, upper bainite, lower bainite, carbides

Fig. 2 (a ÷ f). The microstructure of the investigated kinds of cast iron

It results from Figure 2 (a ÷ f) that the matrix of the tested cast iron consists of ausferrite (a), pearlite (b), pearlite and 10% carbides (c), upper bainite (d), upper bainite and 5% carbides (e) and a mixture of upper bainite (65%) with the lower (30%) and carbides (5%) (f).

Studies of the abrasion resistance were conducted for the quartz sand with 0.20/0.32/0.40 main fraction and M79 homogeneity index according to PN-85/H-11001. The results are shown in Figure 3.

From Fig. 3 follows that the mass loss of the tested cast iron is linear. For pearlitic nodular cast iron carbides with the surface fraction equal to 10% caused a reduction of the mass loss of 0,147g (i.e. about 11%). For bainitic cast iron carbides with the surface fraction of 5% resulted in the increase in wear resistance (approximately 6%). Cast iron with pearlitic matrix showed after an eight-hour test period, the mass loss of 1.337 g. It was about 19% higher in comparison with cast iron containing upper bainite.

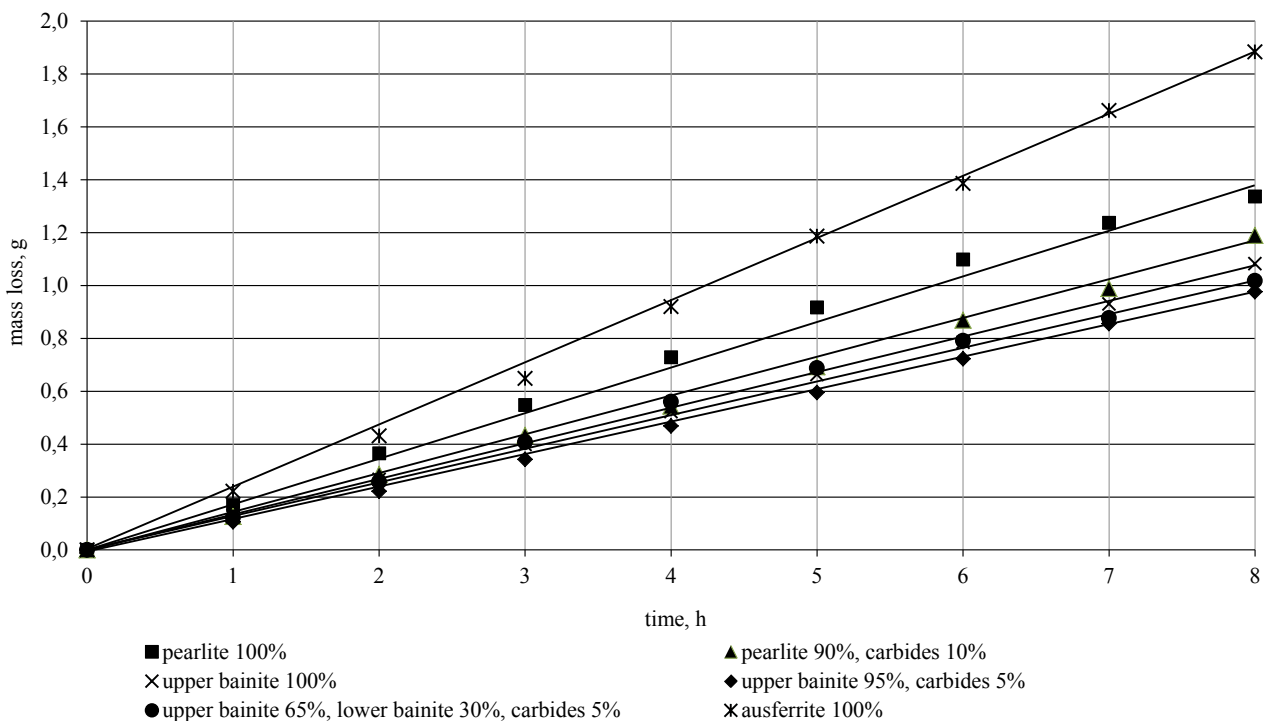

Fig. 3. The effect of the carbides and type of the nodular cast iron matrix on the abrasive wear resistance with the cooperation with the quartz sand

The greatest wear resistance in cooperation with quartz sand showed the cast iron with upper and lower bainite, and carbides under selected conditions. The mass loss was 0,997 g and was slightly (of about 4%) lower compared with cast iron containing upper bainite and carbides. The lowest wear resistance under the conditions tested showed an ausferritic cast iron. The mass loss of the specimen was 1.883 g and was approximately 29% higher in

comparison with pearlitic cast iron. This fact could be due to low unit pressure which makes difficult or impossible the occurrence of the strengthening.

Effect of the carbides and the type of the matrix of nodular cast iron on its abrasive wear resistance in cooperation with 100 grain abrasive paper is shown in Figure 4.

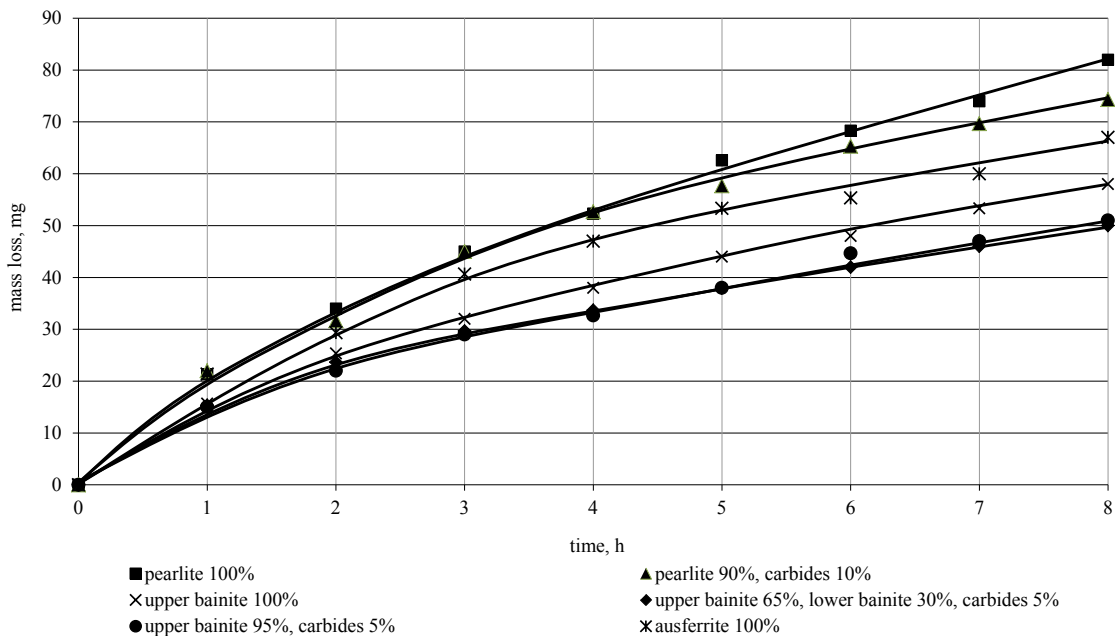

Fig. 4. The effect of the carbides and type of the nodular cast iron matrix on the abrasive wear resistance with the cooperation with 100 grid abrasive paper

Figure 4 shows that at the same unit pressure the mass loss of the cast iron cooperating with abrasive paper was dozen or so smaller in comparison with cast iron cooperating with quartz sand. The mass loss of the studied types of cast iron was not uniform and was reduced during the test. The lowest wear resistance in cooperation with abrasive paper showed pearlitic cast iron. The mass loss of the specimen was 82 mg. Carbides resulted in increased in wear resistance of pearlitic cast iron of about 9%. Cast iron with upper bainite showed approximately 22% higher wear resistance compared to cast iron with pearlitic matrix. Carbides in cast iron containing upper bainite caused 12% increase in its wear resistance. ADI cast iron showed the lower mass loss in comparison with two kinds of the pearlitic cast iron, however greater than the bainitic cast iron. The highest wear resistance in cooperation with abrasive paper showed cast iron with mixture of upper and lower bainite and carbides, and cast iron with upper bainite and carbides. Both the nature of the wear and the mass loss were almost identical.

4. Summary

The research presented in this paper allow to conclude that carbides in nodular iron cause increased the wear resistance. This increase, however, is small (6 to 12% depending on the surface fraction of the carbides and the type of the matrix). In paper [5] it is shown that at for 0.36 MPa unit pressure carbides caused an increase in wear resistance approximately 40 to 50%. It follows that carbides increase the wear resistance of the cast iron to a greater degree with use of higher unit pressure.

A small wear resistance of ADI cooperating with quartz sand was probably caused by a slight unit pressure making difficult or impossible the occurrence of the strengthening.

In cooperation with quartz sand the mass loss of tested cast iron was definitely (14 ÷ 28-times) higher in comparison to the mass loss in cooperation with abrasive paper.

In both cases studied, the highest wear resistance showed nodular cast iron with mixture of the upper and lower bainite, and carbides.

References

- [1] Pietrowski, S. & Gumienny, G. (2010). Bainite obtaining in cast iron with carbides castings. *Archives of Foundry Engineering*. 10(1), 109-114.
- [2] Gumienny, G. (2010). Bainitic-martensitic nodular cast iron with carbides. *Archives of Foundry Engineering*. 10(2), 63-68.
- [3] Gumienny, G. (2010). Chromium and copper influence on the nodular cast iron with carbides microstructure. *Archives of Foundry Engineering*. 10(4), 47-54.
- [4] Gumienny, G. (2011). Wear resistance of nodular cast iron with carbides. *Archives of Foundry Engineering*. 11(3), 81-88.
- [5] Gumienny, G. (2012). The Effect of Nodular Cast Iron Metal Matrix on the Wear Resistance, *Archives of Foundry Engineering*. 12(2), 179-186.
- [6] Rapiejko, C., Fouvry, S., Grosogeat, B. & Wendler, B.G. (2009). A representative ex-situ fretting wear investigation of orthodontic arch-wire/bracket contacts. *Wear*. 266, 850-858.