











CARTILAGE TISSUE EXAMINATION USING ATOMIC FORCE MICROSCOPY

JAROSŁAW PALUCH¹ , JAROSŁAW MARKOWSKI^{1*} , JAN PILCH¹ , WOJCIECH SMÓŁKA¹ , KRZYSZTOF PIOTR JASIK² , FILIP KILIAN³ , WIRGINIA LIKUS⁴ , GRZEGORZ BAJOR⁵ , DARIUSZ CHROBAK⁶ , KARSTEN GLOWKA⁶ , OLIWIA STARCZEWSKA^{6**} 

¹ DEPARTMENT OF LARYNGOLOGY, FACULTY OF MEDICAL SCIENCES IN KATOWICE, MEDICAL UNIVERSITY OF SILESIA IN KATOWICE, FRANCUSKA 20/24, 40-055 KATOWICE, POLAND

² DEPARTMENT OF PATHOLOGY, FACULTY OF PHARMACEUTICAL SCIENCES IN SOSNOWIEC, MEDICAL UNIVERSITY OF SILESIA IN KATOWICE, OSTROGÓRSKA 30, 41-200 SOSNOWIEC, POLAND

³ DEPARTMENT OF GENERAL, VASCULAR AND TRANSPLANT SURGERY, FACULTY OF MEDICAL SCIENCES IN KATOWICE, MEDICAL UNIVERSITY OF SILESIA IN KATOWICE, FRANCUSKA 20/24, 40-055 KATOWICE, POLAND

⁴ DEPARTMENT OF ANATOMY, FACULTY OF HEALTH SCIENCES IN KATOWICE, MEDICAL UNIVERSITY OF SILESIA IN KATOWICE, MEDYKÓW 18, 40-752 KATOWICE, POLAND

⁵ DEPARTMENT OF ANATOMY, FACULTY OF MEDICAL SCIENCES IN KATOWICE, MEDICAL UNIVERSITY OF SILESIA IN KATOWICE, MEDYKÓW 18, 40-752 KATOWICE, POLAND

⁶ INSTITUTE OF MATERIALS ENGINEERING, UNIVERSITY OF SILESIA IN KATOWICE, 75 PUŁKU PIECHOTY 1A, 41-500 CHORZÓW, POLAND

*E-MAIL: JMARKOW1@POCZTA.ONET.PL

**E-MAIL: OLIWIA.STARCZEWSKA@US.EDU.PL

Abstract

Life sciences, a field closely intertwined with human biology and physiology, employ various research methods, including morphology studies and quantitative analysis through non-destructive techniques. Biological specimens often consist of three-phase structures, characterized by the presence of gas, liquid, and solid components. This becomes crucial when the chosen research methodology requires the removal of water from samples or their transfer to a cryostat.

In the current research, mechanical and topographical examination of cartilage was performed. The materials were generously provided by the Department of Anatomy at the Medical University of Silesia, thereby eliminating any concerns regarding their origin or ethical use for scientific purposes. Our research methodology involved the application of atomic force microscopy (AFM), which minimally disrupts the internal equilibrium among the aforementioned phases. Cartilage, recognized as a 'universal support material' in animals, proves to be highly amenable to AFM research, enabling the surface scanning of the examined material.

[Engineering of Biomaterials 167 (2022) 17-23]

doi:10.34821/eng.biomat.167.2022.17-23

Submitted: 2023-04-12, Accepted: 2023-05-05, Published: 2023-05-15



Copyright © 2022 by the authors. Some rights reserved. Except otherwise noted, this work is licensed under <https://creativecommons.org/licenses/by/4.0>

The quantitative results obtained facilitate an assessment of the internal structure and differentiation of cartilage based on its anatomical location (e.g., joints or ears). Direct images acquired during the examination offer insights into the internal structure of cartilage tissue, revealing morphological disparities and variations in intercellular spaces. The scans obtained during the measurements have unveiled substantial distinctions, particularly in the intercellular 'essence', characterized by granularities with a diameter of approximately 0.5 μm in ear cartilage and structural elements in articular cartilage measuring about 0.05 μm . Thus, AFM can be a valuable cognitive tool for observing biological samples in the biological sciences, particularly in medicine (e.g. clinical science).

Keywords: atomic force microscopy, cartilage, biopolymers, chondrocytes, intercellular matrix

Introduction

The tissue structures of the human body are composed of polymers that constitute mainly proteins, polysaccharides, glycosaminoglycans, and the biggest structural molecules, i.e. nucleic acids. The above-mentioned particles have a structure based on chemical bonds, predominantly covalent, ionized between elements, which determines (along with "genetic signpost") their functions - mostly in biochemical reactions or as a structural material. Different types of structures could also be observed in the human body, such as cartilage structures. These cartilages consist of polymers defined as protein molecules, e.g. collagen, elastin, or fibronectin. The histological diagrams of vitreous, fibrous, and elastic cartilages are presented in FIG. 1.

Cartilage is made up of cells called chondrocytes and a well-developed intercellular substance consisting of fibers and a basic substance called a matrix. Cartilage does not contain blood or lymphatic vessels and is not innervated. Apart from the articular surfaces, it is covered with well-vascularized, fibrous connective tissue. Depending on the structure of the intercellular substance and performed function, three types of cartilaginous tissue are distinguished: vitreous (type II collagen), fibrous (type I collagen), and elastic (a dense meshwork of elastic fibers) (FIG. 1). Laryngeal and articular cartilage are naturally cartilaginous, whereas auricular cartilage is elastic. The vitreous cartilage of the adult body constitutes most of the larynx cartilage, the cartilaginous trachea and bronchi rings, the cartilaginous parts of the ribs, the nasal septum, and covers the articular surfaces. Vitreous cartilage is a hard elastic tissue of a bluish-white color. The cartilage surface is covered by the perichondrium. Under the perichondrium is the subchondral zone containing spindle-shaped chondrocytes arranged in a few layers. These cells lie in cavities separated by a large amount of intercellular substance. Deep in cartilage, chondrocytes have a spherical shape; they are also larger and form groups called chondrons. The cells of a single chondron originate from the same parent cell and are called isogenic groups. Within the isogenic group, the chondrocytes are separated by the thin layer of the extracellular substance [2,3]. Chondrocytes are metabolically active cells that synthesize components of extracellular substances. They have one or two vesicular nuclei. The extracellular substance of vitreous cartilage is made up of collagen fibers and the basic substance (matrix). Collagen fibers account for about 40% of the dry cartilage mass.

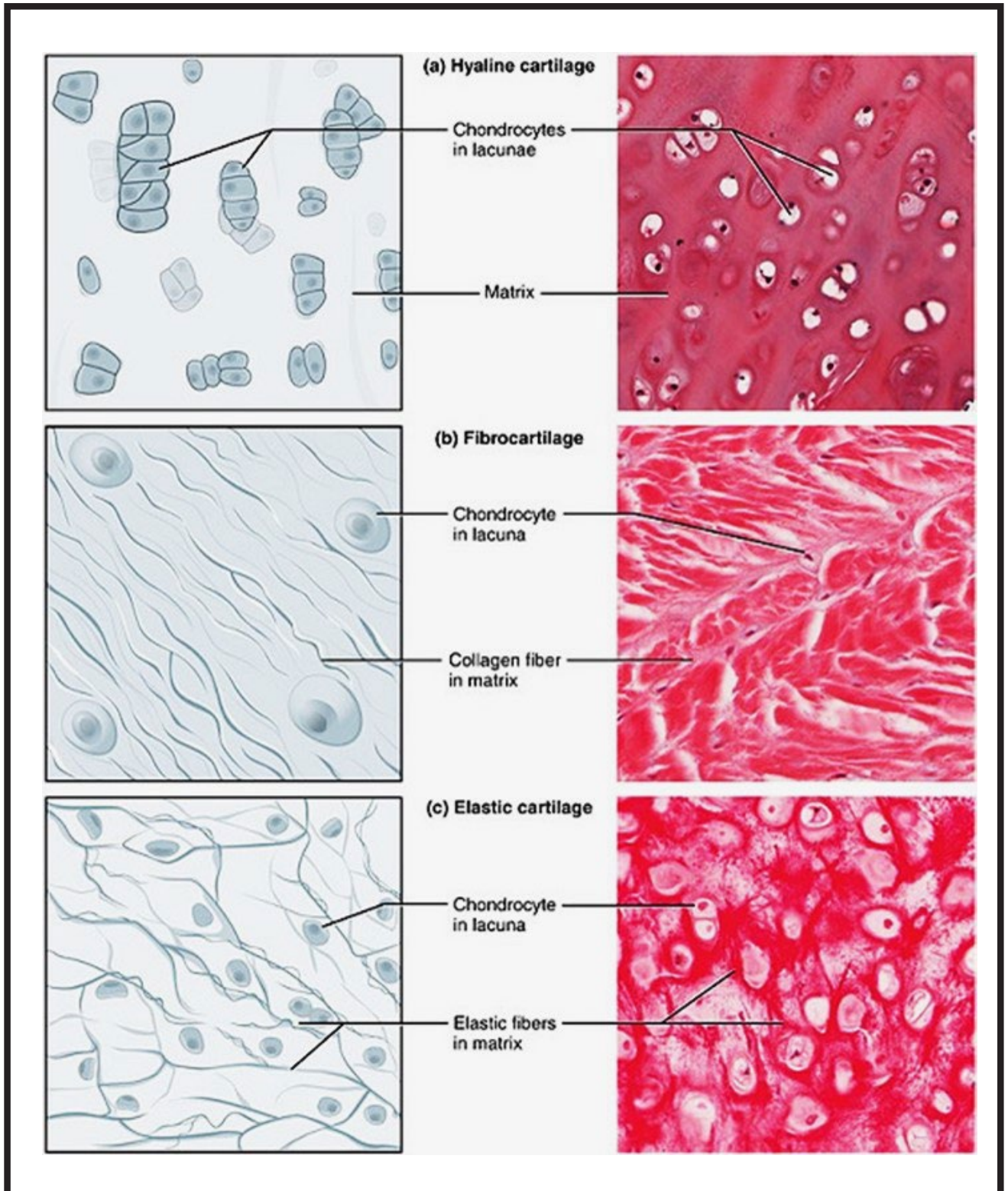

FIG. 1. Histological diagram of vitreous cartilage (a), fibrous cartilage (b), and elastic cartilage (C) [1].

Made up of type II collagen, they occur as thin fibers arranged in a dense, irregular network. The arrangement of collagen fibrils is more organized and in line with the direction of loads in vitreous articular cartilage. Due to their small diameter and the same refractive index as the basic substance covering them, the fibers are invisible in standard preparations. The main components of the basic substance include hyaluronic acid and proteoglycans, both of which influence cartilage hardness and elasticity. Elastic cartilage is found in the auricle, external auditory canal, auditory trumpet, epiglottis, and small cartilages of the larynx.

Its overall structure is similar to vitreous cartilage. The two- and three-celled chondrons found here are regularly distributed in a small amount of the intercellular substance. The distinguishing feature of elastic cartilage tissue is the presence of a dense meshwork of elastic fibers. The amount of collagen II fibrils is limited. Due to such a structure, deformed cartilage quickly returns to its previous shape. Elasticity and deformability are the main characteristics of elastic cartilage [4].

It is worth mentioning that contemporary research methods focusing on solid-state physics and material science can be used in qualitative and quantitative assessment at micro- and nanometric resolution of both natural and synthetic materials. According to the broad literature review, materials engineering has, in its cognitive arsenal, research techniques applied in analyzing materials of human origin that are at the borderline of biology and medicine. Available research methods allow for conducting complex studies at the molecular level and imaging techniques such as light microscopy, fluorescent microscopy, confocal microscopy, and advanced observations using electron microscopy, including cryogenic microstructure observations.

On the other hand, in the above-discussed research methods, synthetic materials pose a minor research problem. Regarding biological objects, the data found in the literature on the subject of biomedical/material engineering emphasize a wide use of scanning electron microscopy (SEM), scanning-transmission electron microscopy (STEM), and transmission electron microscopy (TEM), X-ray spectroscopy, Raman spectroscopy, time-of-flight secondary ion mass spectrometry (TOF-SIMS) and matrix-assisted laser desorption/ionization (MALDI-TOF). The literature on the subject also includes some reports on the use of atomic force microscopy (AFM) with nanoindentation and the discussed microscopic and spectroscopic observation methods using synchrotron beams in research into living matter. Currently, this situation, due to significant technological developments, is increasingly evolving and allows for performing previously unavailable measurements.

The authors of the presented research undertook the challenge of a mechanical and topographical examination of cartilaginous tissues. The discussed tissues are the macroscopic building blocks of the mammalian body (including human) with a functional relationship to bone, muscle, and fascial structures. Therefore, it is essential to gain the best possible understanding of their internal structures and differentiation. In the current stage of advanced technological development, one of the methods of investigating this issue is atomic force microscopy and related methods of assessing mechanical properties (e.g. nanoindentation).

Materials and Methods

The research subjects were ear cartilage and articular cartilage (FIG. 2). The research material came from the Department of Normal Anatomy of the Silesian Medical University. The first step in sample preparation was sample drying at room temperature for seven days. The samples were then immersed in alcohol for the next seven days. After this time, the cartilages were sectioned into small, thin slices. The final stage was fixing the analyzed cartilages on a basal slide, as shown in FIG. 2.

Atomic force microscopy (AFM) analysis was performed using a HYSITRON TI950 TriboIndenter (Bruker, Billerica, MA, USA). It is an integrated system with three measurement heads: an atomic force microscope model AFM QScope™ 250, a nanoindenter, and a precision light microscope. It allows for examining a wide range of engineering materials and, to a limited extent, biological specimens. The area for AFM examination was selected based on the image obtained from the light microscope. Tribological cartilage testing was carried out using the Q-WM190 low-frequency tapping mode probe (tip-a) with a length of 225 μm , an elastic constant of 48 N/m and a resonant frequency of 190 kHz. The results were processed using the manufacturer's software - Hysitron TriboScan and Quesant Atomic Scan SPM (FIG. 3).



FIG. 2. Cartilage preparations placed on a basic slide.

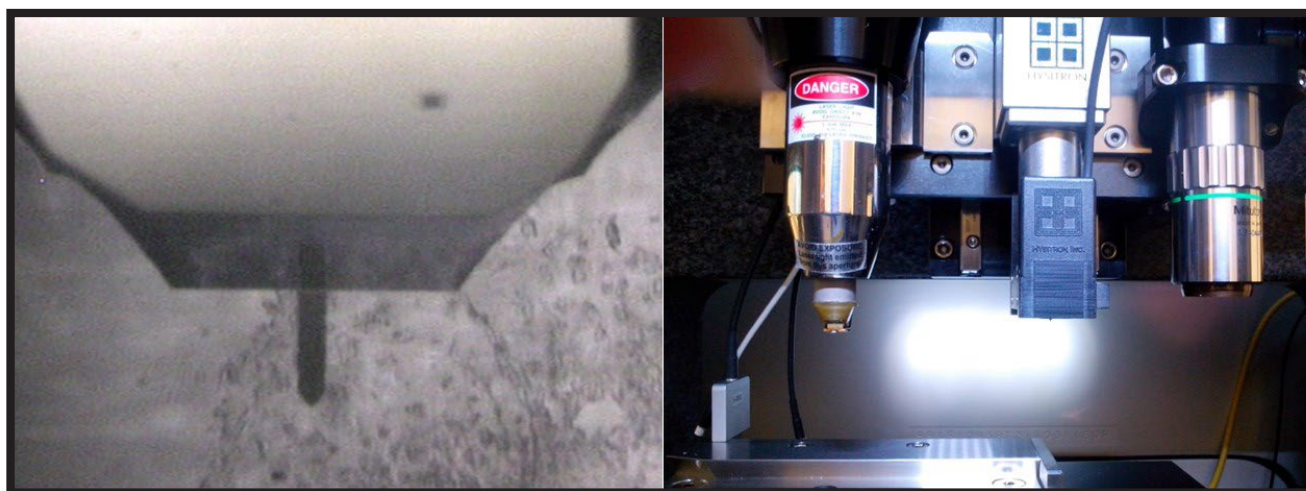

FIG. 3. View of the AFM Q-WM190 probe and measurement heads (AFM, nanoindentation, light microscope) included in the HYSITRON TI950 TriboIndenter.

In the atomic force microscopy technique, a scanning probe moves along the sample and measures at successive points whose distance from each other depends on the desired resolution [5-6]. The AFM method allows imaging of micro- and nanoscale structures in three dimensions (3D). Moreover, atomic force microscopy measurements can be carried out under varied environmental conditions, even when chemical reactions are performed. The measurements provide information on physicochemical and mechanical parameters such as roughness, frictional force values between the blade and the surface of the studied sample, adhesion forces, viscosity, and microhardness. It should also be underlined that the AFM technique allows for the characterization of biological materials [5-8]. The main advantages of the AFM method are the possibility of obtaining three-dimensional images at the nanoscale, the short measurement time, the resolution, and "in situ" measurements [5-8]. Moreover, during the AFM measurements, the three modes can be chosen (further in the text). The block diagram of the atomic force microscope is presented in FIG. 4. The essential elements of the atomic force microscope include a measuring head (containing, among others, a system for monitoring probe lever deflection and a piezoelectric scanning system), and a control unit directly connected to a computer. The operating principle of the microscope is based on the bending of the lever on which the probe (called the *tip*) is placed as a result of the activity of forces between the probe and the surface. As the probe is moved along the surface, the lever deflection is measured using a focused laser beam that strikes the photodetector after reflecting off the lever surface. Each deflection of the lever causes a change in the position of the laser spot on the detector, which makes it possible to determine the difference in the lever position with an accuracy of less than 1 nm. Changes in the position of the laser spot in the photoelement are converted into electrical impulses. Then the impulses are transformed, and transmitted to a computer, thus allowing for the registration of a force map for each point on the surface, which is processed into an image by the computer.

However, the image obtained from the microscope provides only part of the information received when the sample is scanned, since scanning can also provide additional information on its roughness [5]. An operating principle of the atomic force microscope is schematically presented in FIG. 5. The tip is situated on an elastic micro-lever whose deflection enables determining the interatomic interaction between the atoms of the tip and the studied surface. Movements of the probe lever are recorded using a deflected laser beam on a four-section photodetector, due to which the computer generates a topographic map of the analyzed surface [5].

From the measuring point of view, the atomic force microscope can operate in three modes: contact, non-contact, and tapping. In the contact mode, short-range interatomic interaction forces are used. The tip is in contact with the sample during scanning. The applied force on the surface ranges from 10^{-11} N to 10^{-7} N, which creates a tight contact area. During scanning, a probe with a low elastic constant ($c < 1$ N/m) minimizes the interaction force between the tip and the sample. The force is measured by recording the deflection of the free end of the lever with the tip during the scanning.

On the other hand, the contact mode is characterized by the possibility to obtain high-resolution images due to the increased adhesion forces caused by surface contamination. However, the possibility of damage to the sample or the tip is high. Non-contact imaging uses magnetic, electrostatic, and van der Waals forces. The distance of the tip from the sample ranges from 1 to 10 nm. The lever length is approximately 100-200 μm , and the response to the force acting on it changes the amplitude and vibration frequency, which provides the information needed to register an image. However, compared to the contact mode, it allows obtaining images with lower resolution.

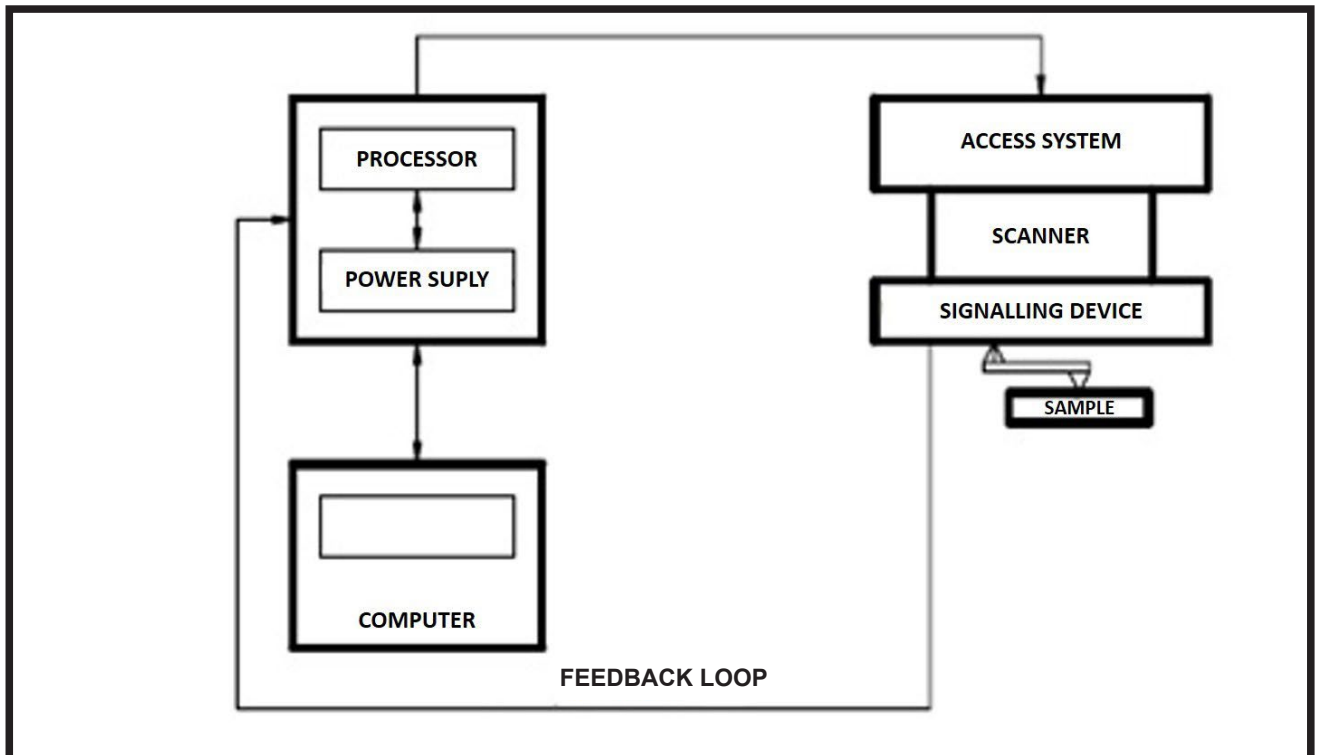

FIG. 4. Block diagram of the atomic force microscope [6].

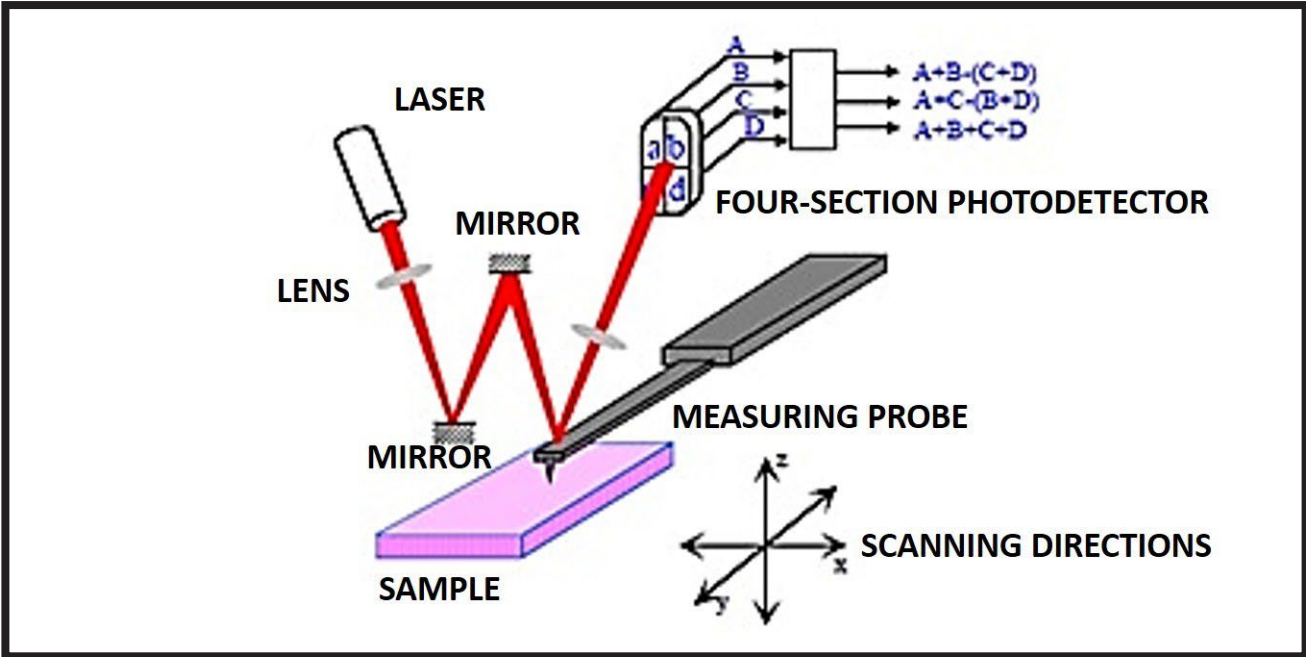

FIG. 5. Scheme illustrating the operating principle of the atomic force scanner [6].

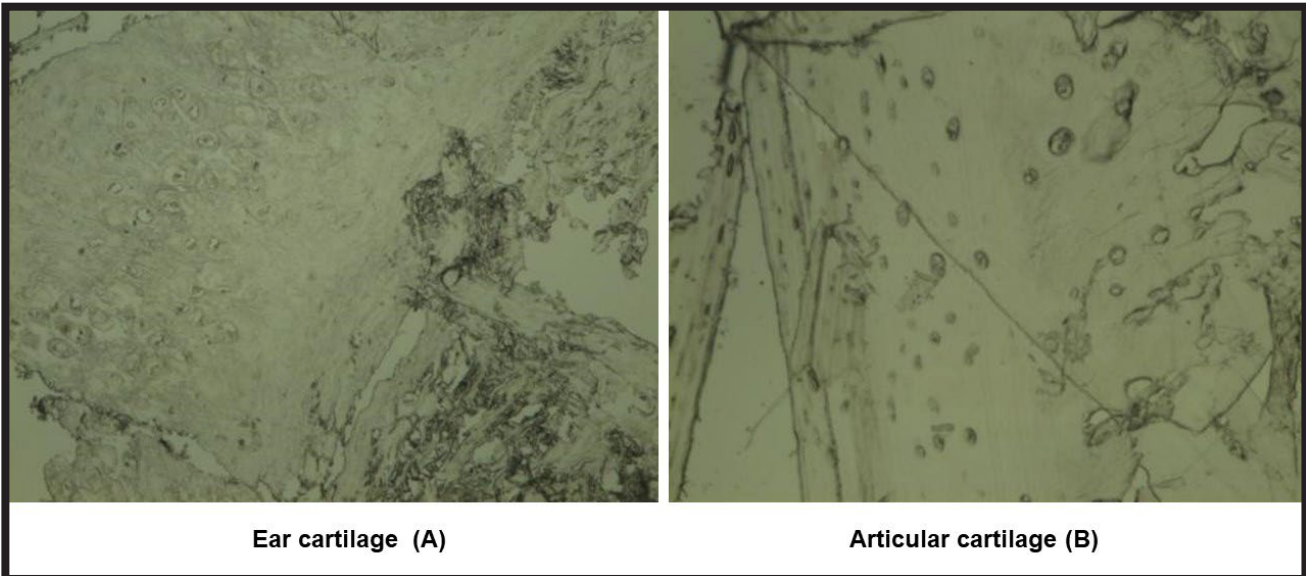

FIG. 6. Microstructure images of ear cartilage (A) and joint (B) collected using a light microscope.

In tapping mode, both long-range and short-range forces are used to obtain the image. Scanning the surfaces of the “soft” materials is also possible since no damage is done to the scanned surfaces. This mode needs a high spring constant of the lever (20-80 N/m) and its high resonance frequency (200-400 kHz). The oscillation amplitude is significant at >20 nm, while the tip has no contact with the sample. The tapping contact mode is also characterized by good resolution, as in the case of the contact mode. During scanning of the sample in the tapping mode, information from the surface morphology, roughness, adhesion, and hardness is provided.

Results and Discussion

FIG. 6 shows images recorded using a light microscope of the ear and articular cartilage tissue, respectively. As can be seen, the elastic cartilage specimen from the ear (FIG. 6A) contains a significant density of chondrocytes distinct from a large amount of extracellular substance and forms isogenic groups in places. A different nanostructure was observed in the articular cartilage (FIG. 6B), classified as vitreous cartilage.

The microstructure image shows that the density of the chondrocytes is relatively low and that they occur as single cells, not as groups. Besides, in addition to individual chondrocytes, there is a large amount of extracellular substance in the examined material.

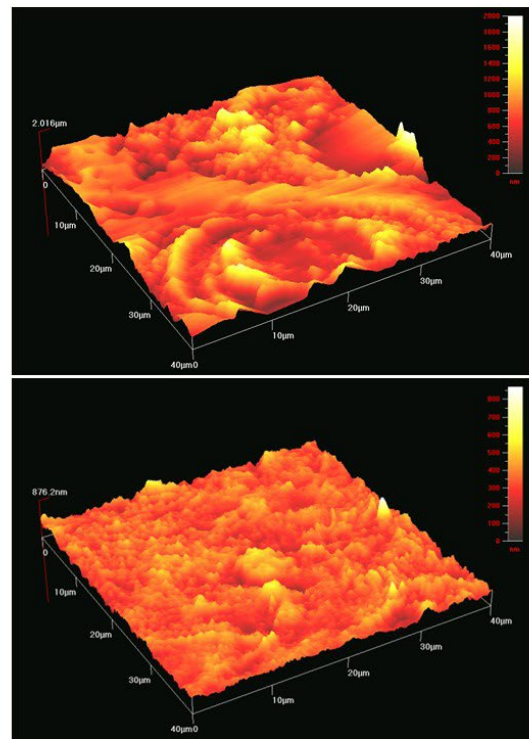
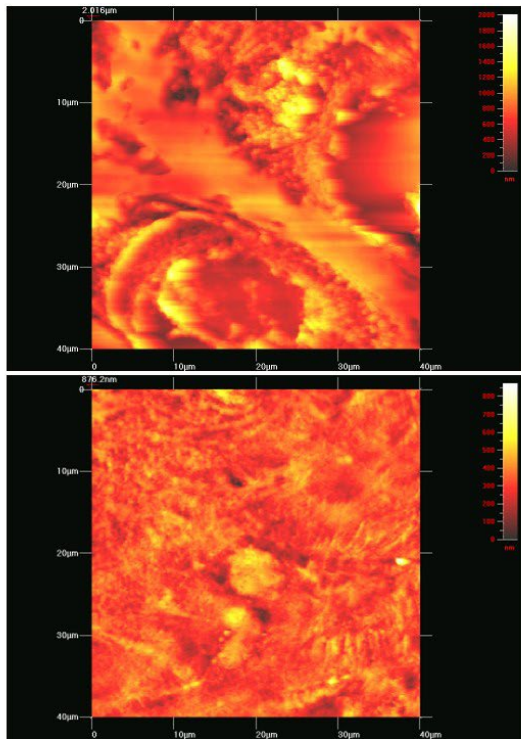

FIG. 7. AFM scan images for ear cartilage in 2D and 3D. The top image shows two chondrocytes, and the bottom shows the extracellular matrix.

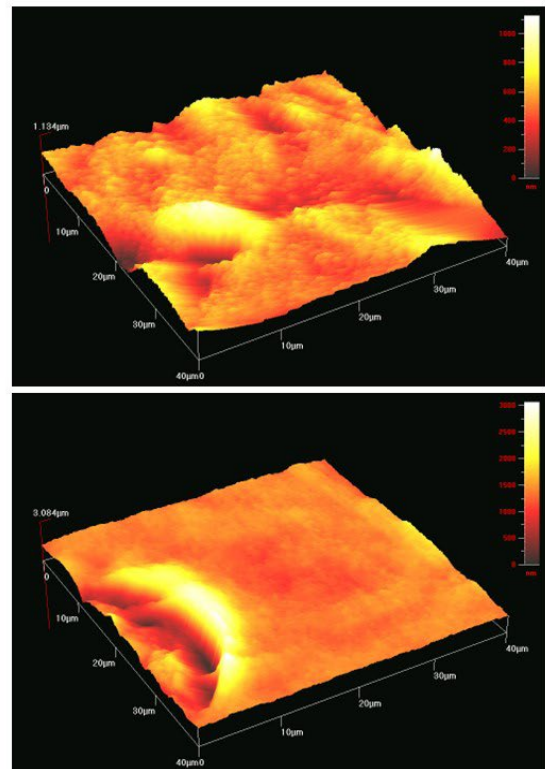
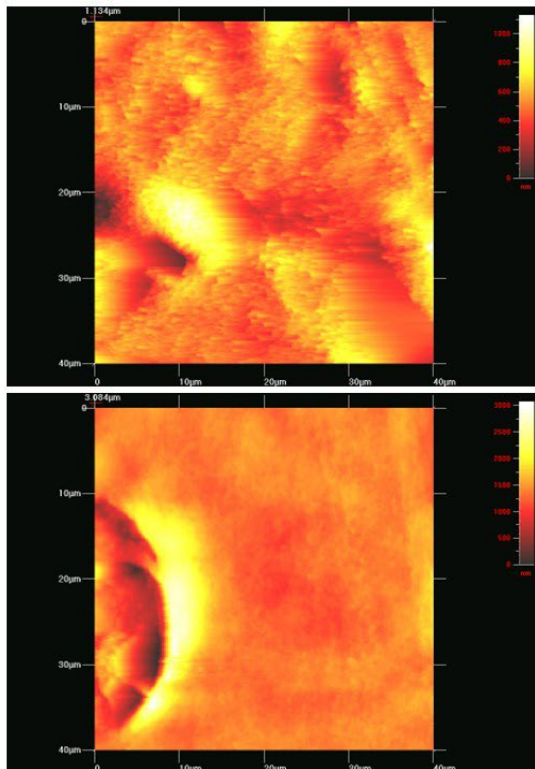

FIG. 8. AFM scan images for articular cartilage in 2D and 3D. The top image shows the extracellular matrix and the bottom image shows a single chondrocyte.

For better visualization of the ear cartilage structure at high-resolution, 2D and 3D AFM surface topography scans were performed (FIG. 7). Obtained images revealed the complex structure of ear cartilage. Additionally, 2D and 3D images clearly showed the typical cellular structure of elastic cartilage, where chondrocytes lie close to each other. The chondrocyte is clear and significantly distinct from the extracellular matrix. The cell depths range from 0 to 2,000 nm, while the matrix depth is no higher than 600 nm.

Similar high-resolution, 2D and 3D visualization of the microstructure of studied articular cartilage is presented in FIG. 8. Nanostructure images of articular cartilage (vitreous cartilage) presented a negligible proportion of chondrocytes as the building block of this type of tissue. As it can be seen, there is a predominance of the extracellular matrix whose depth, like in the case of ear cartilage, is about of 600 nm. On the other hand, the clustered chondrocytes found in elastic cartilage and the chondrocytes in vitreous tissue are much more separated from the matrix, with depths of up to 4,000 nm. What is also worth mentioning is a different type of intercellular matrix in which defined fibrous structures (collagen fibers) are found. It is much more compact and smoother compared to ear cartilage.

Conclusions

In the presented work, the atomic force microscopy (AFM) technique was used to characterize the surface of the ear and articular cartilages in 2D and 3D, respectively. Based on the recorded 3D images, it can be seen that both studied cartilages were built from the intercellular matrix and chondrocytes (two chondrocytes for ear cartilage and a single chondrocyte for articular cartilage). The depth differences between the intercellular matrix and chondrocytes were also observed and measured. It was revealed that the depth of the intercellular matrix for the investigated cartilages was lower than 600 nm. Depth measurements of chondrocytes showed that for articular cartilage was higher (about 4,000 nm) in comparison to the ear cartilage (about 2,000 nm).

As one of the research methods applied in natural and synthetic materials engineering, the atomic force microscopy technique also can be used in biological and medical sciences. The main advantages of the AFM include:

- possibility of the observation of biological objects that do not require complex or challenging sample preparation process, as in the case of electron microscopy methods (SEM, STEM, TEM, cryo-EM),

- absence of changes caused by object preparation in the structure of the studied material, e.g. the use of fixatives and dehydration,
- low costs of preparation and methodology of the conducted measurements,
- the scanning modes of the surfaces of the observed objects generate high-resolution, three-dimensional visualization images combined with precise mapping of depth and height shown on the color change scale,
- precise comparison of the structures of individual tissues on a nanometric scale, with mapping of the smallest differences occurring in the cells (chondrocytes) and the surrounding space (extracellular matrix),
- morphological differentiation of the extracellular matrix with nanometric resolution allowing to assign the object according to its origin (joint, ear).











Moreover, the obtained research tasks revealed their innovative and applied character from the scientific perspective on the borderline of biomedical and material engineering, biology, and medicine. Particular emphasis should be placed on the usefulness of the AFM technique in understanding and differentiating human cartilage structures, e.g. in terms of its morphology and nanostructure.

The obtained research findings reveal the potential for future use of atomic force microscopy as a diagnostic tool in transplantology.

Acknowledgements

Research financed by the project PCN-1-082/K/0/O (Medical University of Silesia in Katowice).

ORCID iD

J. Paluch:	 https://orcid.org/0000-0001-7675-0623
J. Markowski:	 https://orcid.org/0000-0003-3416-7354
J. Pilch:	 https://orcid.org/0000-0001-6792-0985
W. Smółka:	 https://orcid.org/0000-0003-4074-9705
K.P. Jasik:	 https://orcid.org/0000-0003-3974-6507
F. Kilian:	 https://orcid.org/0000-0002-2658-1451
W. Likus:	 https://orcid.org/0000-0002-4738-6102
G. Bajor:	 https://orcid.org/0000-0002-7195-8422
D. Chrobak:	 https://orcid.org/0000-0003-1766-1350
K. Glowka:	 https://orcid.org/0000-0002-1889-5557
O. Starczewska:	 https://orcid.org/0000-0002-7659-2909

References

- [1] <http://www.differencebetween.net/science/health/difference-between-hyaline-cartilage-and-elastic-cartilage/>
- [2] Zabel M.: Histologia - podręcznik dla studentów medycyny i stomatologii, Wydawnictwo medyczne Urban& Partner, Wrocław (2005).
- [3] Malejczyk J.: Budowa i immunologia tkanki chrzęstnej, Acta Clinica 1 (1) (2001) 15-22.
- [4] Sawicki W.: Histologia, Wydawnictwo Lekarskie PZWL, Warszawa (2005).
- [5] Rymuza Z.: Advanced techniques for nanotribological studies, Scientific Problems of Machines Operation 1 (161) (2010) 33-43.
- [6] Bramowicz M., Kłysz S.: Zastosowanie mikroskopii sił atomowych (AFM) w diagnostyce warstwy wierzchniej, Zeszyty naukowe ITWL, zeszyt 22 (2007) 159-166.
- [7] Gotszalk T.P.: Systemy mikroskopii bliskich oddziaływań w badaniach mikro i nanostruktur, Oficyna Wydawnicza Politechniki Wrocławskiej (2004).
- [8] Ilnatouski M., Pauk J., Karev D., Karev B.: AFM-Based Method for Measurement of Normal and Osteoarthritic Human Articular Cartilage Surface Roughness, Materials 13 (2020) 2302.