

Design and Implementation of a Versatile Flexible 3D Wire Bending Machine with Accuracy Algorithm

Mohammed O. Farhan¹, Muhannad M.H. Al-Khafaji^{2*}, Muhannad Q. Abood³

¹ Production Engineering and Metallurgy Department, University of Technology, Baghdad, Iraq

* Corresponding author's e-mail: Mohanned.M.Hussein@uotechnology.edu.iq

ABSTRACT

This paper presents the development of a flexible wire bending machine designed to overcome limitations associated with traditional counterparts. Traditionally, wire bending machines are often designed for specific purposes, necessitate complex coding, are prohibitively expensive, or are constrained to producing two-dimensional shapes. To address these challenges, our study begins with an extensive review of existing research in the field, followed by the selection of a concept derived from this analysis. The methodology encompasses the entire design and manufacturing process. Initial research guides the concept selection, which is then translated into a practical design using SolidWorks simulations. The theoretical foundation involves mathematical formulations for each machine component, ranging from the wire feeding system to the bidirectional and 3D bending mechanisms. Main actuators are chosen based on calculated parameters, and the machine is assembled, incorporating a CNC system. The machine is tested first without wire and subsequently with the bending of an aluminum (1350-H26), 3.2 mm diameter wire, copper with 3.25 mm diameter and steel with 2.5 mm diameter. The results demonstrate high accuracy performance and underscore the significance of considering spring back and bend allowance for precision in both 2D and 3D wire configurations. This study not only contributes to the design and fabrication of a flexible wire bending machine but also addresses the shortcomings of traditional counterparts, making wire bending more accessible, versatile, and cost-effective.

Keywords: wire bending, CNC, springback, bend allowance.

INTRODUCTION

Wire bending machines are widely used in various industries to manufacture metal components with precise shapes and dimensions. The wire bending process involves bending a metal wire or rod to a specific angle or shape, which requires a high level of accuracy and repeatability. Traditional wire bending machines are designed for specific wire bending applications and may not be flexible enough to handle different wire sizes, shapes, or materials. Therefore, there is a need for a more flexible wire bending machine that can handle a wide range of wire bending applications and also has convenient operation. Designing and manufacturing a flexible machine for wire bending is an attractive task that combines innovation, precision engineering, and automation. We intend

to present machine which is a prototype offering increased, versatility, and accuracy in producing wire-based components for various applications.

Kumar et al. [1] presented prototype rebar bending machine uses 3 mm aluminum wire to produce rectangular frames. Stepper motors drive wire feeding, bending, and product separation. An Arduino Nano microcontroller controls the steppers via Arduino IDE-written programs. However, the current setup requires manual Arduino C code adjustments, making it inconvenient and requiring re-setup for different product shapes. Murata and Takashi [2] discussed various tube bending methods used in industries, focusing on MOS bending – a 21st-century innovation developed by Nissin Precision Machines Co., Ltd. MOS bending challenges traditional techniques, offering flexibility, high precision, and the ability

to bend tubes in different directions without die replacement. The article outlines MOS bending’s advantages, explains its mechanism, and presents examples of products created using this innovative method.

Lavric et al. [3] upgraded wire bending machine with a control system for stable rib geometry. Inner loops control forces in horizontal and vertical planes, adjusted based on reference values. An outer loop considers variations in rib geometry. Stepper motor-driven wedge systems achieve roller displacements, and final rib geometry is analyzed using image processing. Wenxian et al. [4] introduced a DC wire-bending machine enabling bending at any angle. The machine integrates a storing, straightening, feeding, and wire-bending mechanism. The storing mechanism resets automatically, eliminating manual adjustments for speed differences. The wire-bending mechanism, with double heads, facilitates asymmetric bending. A clamping device ensures stability and increased rotational accuracy.

Liu et al. [5] introduced a task and motion planner for a collaborative robot to perform 3D metal wire curving tasks with a bending machine. The planner considers task and motion constraints, generating bending sequences, machine usage, robotic grasp poses, and arm motion. Notably, it is suitable for high-stiffness materials, showcasing flexibility and robustness in various tasks. Top of Form El-Aty et al. [6] reviewed free bending forming (FBF) technology for manufacturing intricate metallic tubes. Explored historical development, theoretical principles, deformation mechanisms, critical parameters, forming defects, machine design, and solutions. Concluded with discussions on design methodology and the future outlook of FBF technology.

Gaspar et al. [7] developed an innovative concept to increase production rates and flexibility for bent wires in car seat cushions. The approach, incorporating mechanical solutions and automation, achieved a production rate of 950 parts/hour, a 30-minute setup time, and reduced tool costs compared to traditional methods. Applicable to various products. Goto et al. [8] introduced a new bending machine has been that can adjust tube bending by moving a die. It allows for easy shape changes without altering the tooling system, incorporating a precise 6-DOF parallel kinematics mechanism for dynamic motion control. This machine is beneficial for applications in interior design, universal products, and automotive parts,

addressing challenges faced by traditional bending machines.

The goal of this paper is to create an automated machine capable of bending wires of different shapes, sizes, and materials, while ensuring consistent quality and minimizing human intervention. By employing advanced technologies and intelligent design principles, we aim to enhance productivity, reduce production costs, and meet the evolving demands of modern manufacturing processes. The demand for sophisticated and adaptable machinery in the field of industrial automation is increasing. Wire bending, which plays an active role in various industries such as automotive, electronics, construction, medical, and decoration, requires inventive solutions that can handle different wire shapes and sizes. This research presents the conceptualization, design, and production of an advanced wire bending machine that is flexible and aims to contribute to the wire manipulation industry.

METHODOLOGY

Studying the previous researches in the field lead to selection the concept design, based on theoretical principles the effective parameters has been determined and consequently the main actuators were selected, after that the machine assembled and control system has developed to achieve the targeted precision. and finally, a CAD algorithm with advance CAM system was developed. the methodology summarized as shown in Figure 1.

MACHINE DESIGN

Figure 2 and Table 1 shows the machine design and key component. The proposed mechanism shown in Figure 3. Below procedure was conducted to estimate the required torque of the actuator:

- Calculate the tangential force to unwind the wire from spool based on the theoretical consideration mentioned in the previous chapter. The tangential force is equal to mass for the spool and wire multiplied by the centripetal acceleration:

$$F_c = m \cdot a$$

$$F_c = (m \cdot v^2)/r$$

We know the mass of the spool with the wire is 6 kg. We know the radius of the spool is 150 mm or

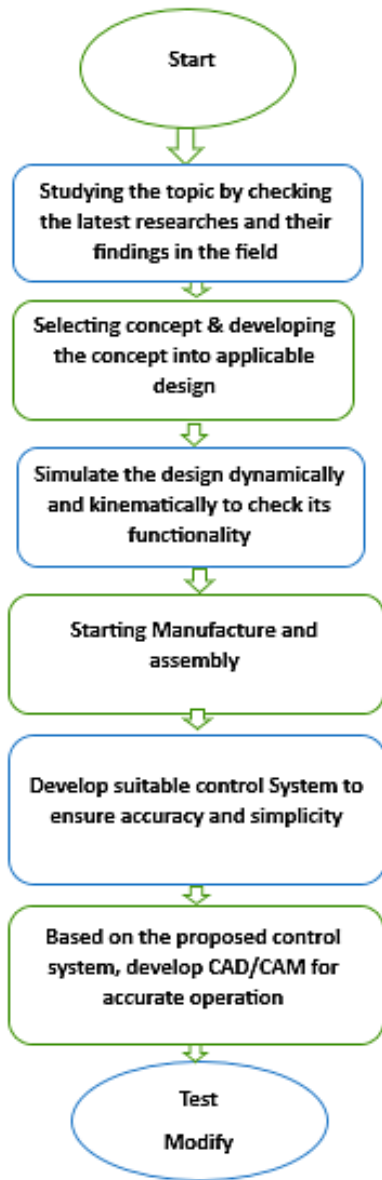

Figure 1. Methodology flow diagram

0.15 m. Now $a = v^2/r$, where v is the linear velocity which represent the wire feed rate in our concept, we will use high velocity to keep our estimation in safe side. So, we will use 20 m per minute as velocity which means feed rate of 20000 mm per minute:

$$a = (20)^2/0.15 = 0.7407 \text{ m/s}^2$$

$$F_c = 6 \cdot 0.7407 \text{ kg} \cdot \text{m/s}^2 = 4.4442 \text{ N.}$$

- Now we will find the friction force produced by using the additional spring friction force equal to force applied by spring multiplied by friction coefficient:

$$F_f = F_s \cdot \mu$$

$$F_s = K \cdot X$$

where: K – is spring constant, and X – is spring displacement.

Table 1. Machine key component

Item No.	Description
1	Main base plate (stationary)
2	Straightener
3	Wire feeder
4	Machine frame
5	3D bending mechanism gear train
6	Secondary base plate (rotating)
7	Aluminum brackets
8	Bidirectional mechanism
9	Bending tool
10	Gear train for bending mechanism
11	Wire guide and nozzle
12	Ball bearing with housing
13	3D bending Nema32 stepper

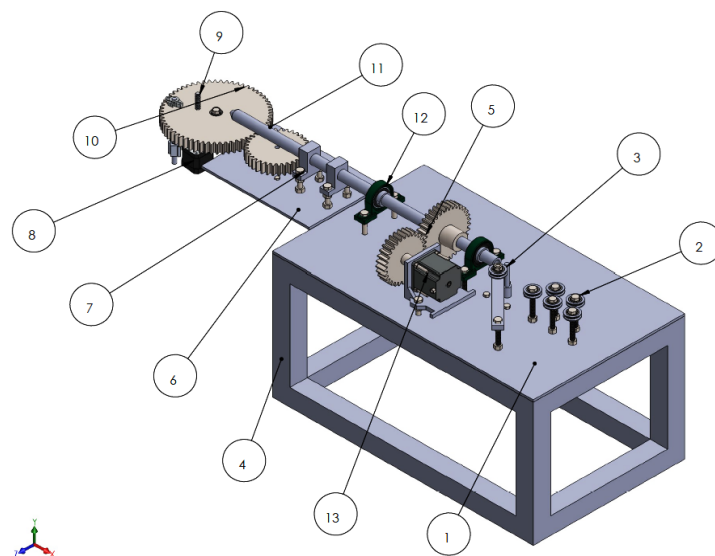

Figure 2. Machine design

We can calculate the spring constant:

$$K = \frac{G \cdot d^4}{8 \cdot N \cdot D^3}$$

$$K = \frac{80000 \cdot (2)^4}{8 \cdot 23 \cdot (12)^3} = 4.025 \text{ N/mm}$$

where: G – shear modulus for spring steel, in our case its steel 1070 and G for it 80 GPa,
 d – spring wire diameter,
 N – number of active spring turns,
 D – spring diameter.

$F_s = 4.025 \text{ N/mm} \cdot 20 \text{ mm} = 80.5 \text{ N}$, by considering the friction coefficient is 1. $F_{total} = F_T + F_{spring} = 4.4442 + 80.5 = 84.944$, approximately is equal to 85 N. Now the torque required is $F_{total} \cdot \text{timing pulley radius} = 85 \cdot 0.006 = 0.51 \text{ N}\cdot\text{m}$. So, our motor torque should be larger than 0.51 Nm.

Bending mechanism

The proposed mechanism as shown in Figure 4, and below procedure was conducted to estimate the required torque:

- Tension test for wire material was conducted to extract its mechanical properties the wire was aluminum 1350-H26 with 3.2 mm diameter.
- Calculating the required torque for bending process – based on the bending theory bending stress can be expressed by the following formula:

$$\sigma_b = -\frac{My}{I}$$

where: M – is the bending moment,
 Y – is the perpendicular distance from neutral axis to the upper or lower layer, in our case it represents the wire radius = 1.6 mm,
 I – is the second moment of inertia for wire section,

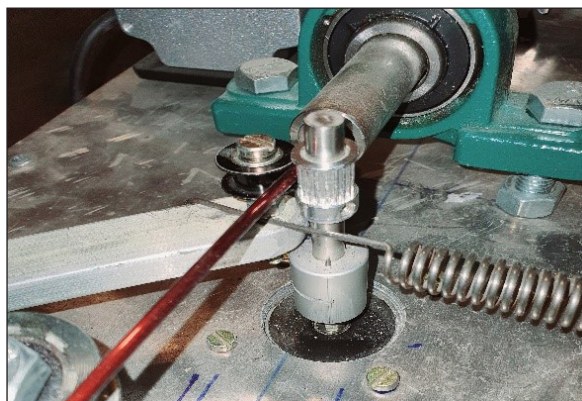

Figure 3. Feeding mechanism

σ_b – is the bending stress in our case it should be equal to yield stress of the wire material as it is pure bending:

$$\sigma_b = \sigma_y = 85 \text{ MPa.}$$

Now we calculate the moment of inertia I for circular cross section:

$$I = \frac{\pi}{64} \times d^4 = \frac{\pi}{64} \times (3.2)^4 = 5.147 \text{ mm}^4$$

Now substitute all value in equation:

$$85 \text{ MPa} = -\frac{M \times 1.6 \text{ mm}}{5.147 \text{ mm}^4}$$

$$M = -\frac{85 \text{ MPa} \cdot 5.147 \text{ mm}^4}{1.6 \text{ mm}} = 273.434 \text{ N}\cdot\text{mm}$$

We know the bending moment is equal to bending force multiplied by bending arm (length of wire from actual bend):

$$M = F_b \cdot 36 \text{ mm} = 273.434 \text{ N}\cdot\text{mm}$$

$$F_b = 273.434 \text{ N}\cdot\text{mm} / 36 \text{ mm} = 7.6 \text{ N}$$

So, the required bending force is 7.6 N. Now we can calculate the required torque to accomplish the wire bending process. The bending force effects on the gear attached to the bending tool, i.e. the driven gear and the arm for that force is the gear radius.

Bending torque is equal bending force multiplied by driven gear radius. We know the radius of the driven gear is 90 mm:

$$T_b = F_b \cdot 90 \text{ mm}$$

$$T_b = 7.6 \text{ N} \cdot 0.09 \text{ m} = 0.684 \text{ Nm.}$$

Assuming the efficiency of the gears is 95%, then $T_2/T_1 = N_2/N_1$, where N_1 is the number of teeth for the driver gear, and N_2 is the number of teeth for the driven gear: $N_1 = 34$, $N_2 = 60$, $T_2 = 0.684$

$$T_1 = \eta (N_1/N_2) \cdot T_2$$

$$T_1 = 0.95(34/60) \cdot 0.684 = 0.37 \text{ Nm.}$$

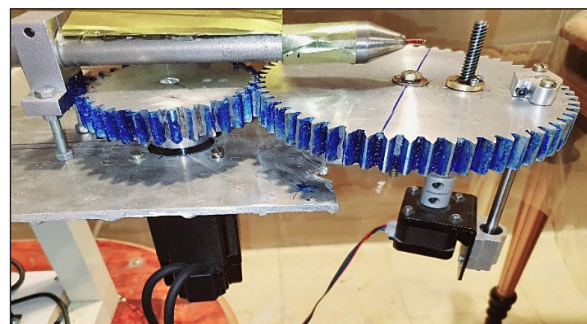

Figure 4. Bending mechanism

Now we calculate the torque required to overcome gear inertia:

$$T_i = J \cdot \alpha$$

where: T_i – is torque to overcome inertia, J – moment of inertia of gear, α – is the angular acceleration which in this case is centripetal acceleration and we work on constant speed.

$$J = \frac{1}{2} \cdot m \cdot r^2$$

For the driven gear with mass of 0.7 kg and radius of 90 mm:

$$J = 0.5 \cdot 0.7 \cdot 0.09^2 = 0.0028 \text{ kg}\cdot\text{m}^2$$

Angular acceleration $\alpha = v^2/r$, where v is the linear velocity of the wire which 20000 mm/min equivalent to 0.3333 m/s.

$$\alpha = 0.3333^2/0.09 = 0.02 \text{ m/s}^2$$

$$T_i = 0.0028 \cdot 0.3333 = 0.0009 \text{ Nm}$$

We will assume the second gear is the same so total torque is: $0.37 + 2 \cdot 0.0009 = 0.371$.

Three-dimensional bending mechanism

The proposed mechanism as shown in Figure 5 and below procedure to estimate the required torque:

- Determine the bending assembly weight which should be attached to the driven gear of the 3D mechanism. In our case the total weight is 6.2 kg represent the weight for:
 - base plate on which the bending mechanism is installed (made from 5 mm aluminum plate),
 - stepper motor (Nema 24) with optical encoder attached to it,
 - set of two gears for bending mechanism,
 - bidirectional mechanism consist of Nema 17 stepper motor with coupler, screw of 16



Figure 5. 3D bending mechanism

cm and diameter of 8 mm, linear ball bearing, shaft for linear ball bearing and two screwed bushes.

- Calculate the torque for the driven gear. The load attached to the driven gear is $6.2 \text{ kg} \cdot 9.8 = 60.76 \text{ N}$. Torque required to rotate the bending assembly is equal to load multiplied by driven gear radius:

$$T_2 = 60.76 \cdot 0.09 \text{ m} = 5.4 \text{ Nm}$$

Let's consider the gear train efficiency is equal 95%, N_1 – number of teeth for driver gear, and N_2 – number of teeth for driven gear.

$$T_2/T_1 = N_2/N_1$$

$$T_1 = \eta (N_1/N_2) \cdot T_2$$

$$T_1 = 0.95 \cdot (30/34) \cdot 5.4 = 4.53 \text{ Nm}$$

Which means the motor torque should be higher than 4.53 Nm. Our selection to overcome the above mentioned torque is Nema 34 stepper motor with holding torque of 6 Nm, to be in safe side. We neglected the torque required to overcome gears inertia, as it is very small value.

Bidirectional mechanism

The proposed mechanism as shown in Figure 6. To estimate the torque required for motor to move a load using screw and bush we need to consider the following factor:

- the mass of the load (which is motor weight + coupling) in our case its 0.4 kg,
- the screw lead pitch,
- the efficiency of the screw and bush assembly lets assumed it 95%.



Figure 6. Bidirectional mechanism

The motor torque is equal to force multiplied by screw lead, and divided by efficiency, where the force is mass multiplied by 9.8.

$$T_r = (0.4 \cdot 9.8 \cdot 4) / 0.95 = 0.02 \text{ Nm}$$

Our selection was Nema 17 stepper motor with holding torque 0.2 Nm.

MANUFACTURING AND CONTROLLING

Materials has been selected based on the design requirements and some parts were manufactured accordingly as shown in Figure 7. Below consideration were taken during this stage:

- Manufacture a physical prototype of the flexible wire bending machine based on the finalized design.
- Ensure the machine’s structural integrity, reliability, and safety during the manufacturing process.
- Optimize the manufacturing process to achieve cost-effectiveness without compromising quality. The final assembly as shown in Figure 8.

Developing a control system

Control system represent the critical part as it is responsible for controlling and coordinating various components and processes. to achieve precise and accurate wire bending. It is responsible for precise positioning, motion control,

feedback correction, safety, and user interaction. It ensures that wire bending operations are accurate, repeatable, and efficient, making wire bending machines suitable for various manufacturing applications where precision and consistency are required. for machine component a high-quality stepper motors with suitable drives been used and an Arduino Mega 2560 was adopted as a main controller. Figure 9 shows the wiring diagram of the machine.

Developing CAD algorithm for accurate production

The first step in this procedure is to draw the product or desired shape in CAD application like we used AutoCAD. Then Identify the intersection point of the shape lines or sides, which will represent the bending points. measure the angle formed by these two lines, which represents the shape angle. assuming the two lines that produce the angle is the feeding wire, which should be straight before bending process. Now we can determine the angular displacement needed for the bending tool as below. Bending tool angular displacement (bending angle) = 180 (straight line wire before bending) – actual shape angle (the angle produced by the intersection of two segment lines) as shown in Figure 10. Additional calculations is considered to compensate spring back effect and bend allowance with setback for more accuracy.

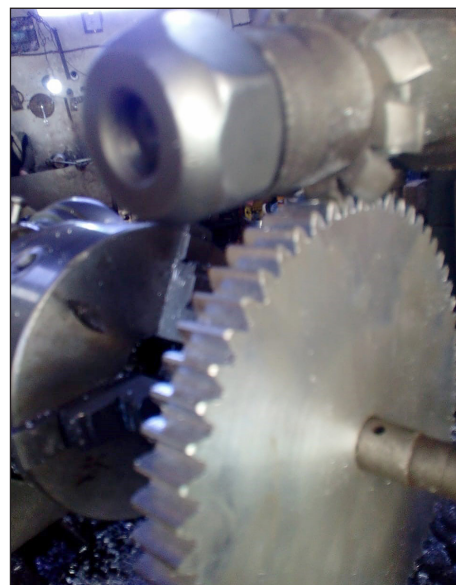

Figure 7. Machine part selection and fabrication

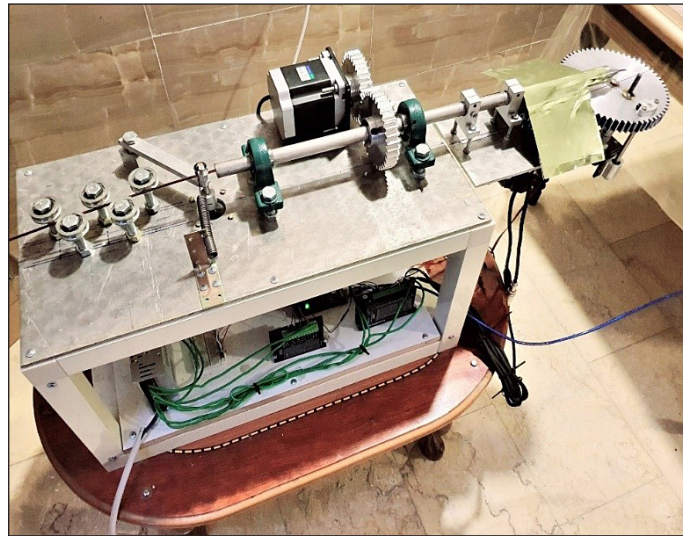

Figure 8. Machine assembly

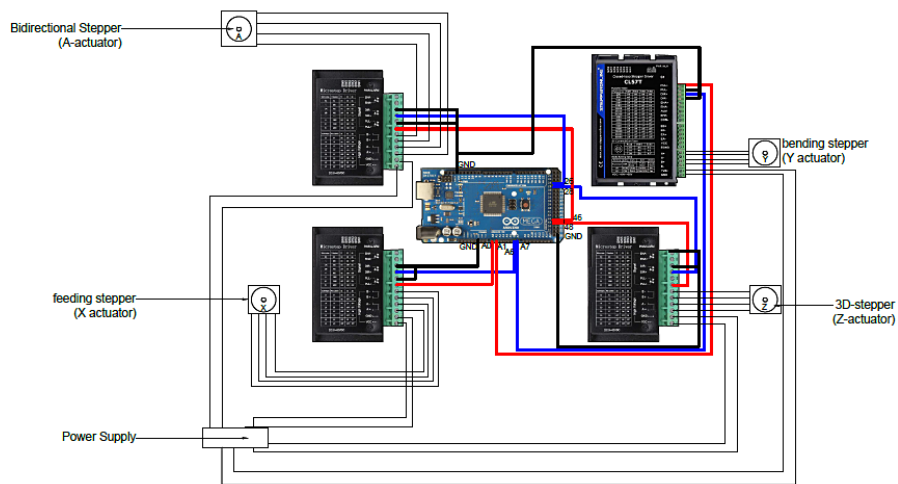
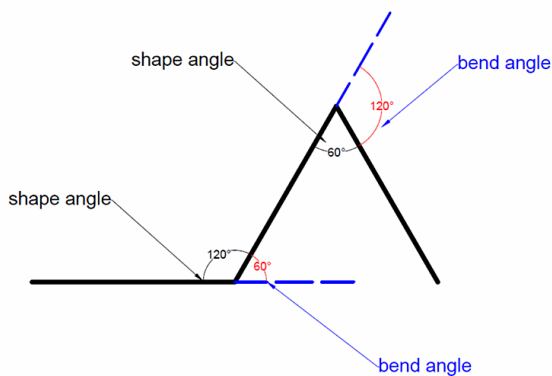

Figure 9. Machine wiring diagram



Bending Angle = 180-shape angle
Negative sign for clockwise direction
Positive sign for counterclockwise direction

Figure 10. CAD algorithm

Developing CAM system

One of the research primary objectives is the flexibility of our presented machine, achieving

this task require suitable C++ Arduino library to be the intermediate link between the C++ complex codes and simple command at the level of simple text file.

First step is downloading the library file from correct source then upload it to the Arduino board using serial port and cable after set the baud rate. Second step is the configuration and the most critical factor in this configuration is step per millimeters and step per radian or degree. This step coming after setting the steps per revolution of the stepper motor or the actuator.

RESULTS

Testing the functionality for each machine component:

- Feeding mechanism test using a vernier with different feed-rate the results as shown in Table 2.
- Bending mechanism test using digital protractor with different feed-rate, as shown in Table 3.
- 3D bending mechanism test using digital protractor with different feed-rate.
- Bidirectional bending mechanism test using vernier with different feed-rate.

Bending accuracy test:

- Testing for bending the wire without spring-back compensation
- Testing for bending the wire with spring back compensation as shown in figures for aluminum, steel, and for copper (Figures 11–14).
- Test for bending wire with spring back compensation and bend allowance with setback consideration as shown in Figures 15 and 16.

- Finally, we tested the machine with complex geometry in both 2D and 3D shapes as shown in Figures 17 and 18.

Comparing the presented machine with the market models

Despite the presented machine in this research is a prototype model and in addition to the literature survey we have done. We made additional survey to the state of art machine available in the market this survey covers below machines:

- WAFIOS multiple-head wire bending machines – handles wire up to 10 mm, offering in-line chamfering and CNC control for efficient bending, straightening, and cutting.
- AWB wire bending equipment – bends 2 mm to 12 mm wire, with welding capabilities and collaboration with subcontractors for diverse finishes.
- Commercial Wire Designs Automated 3D wire forming – uses Macsoft machines for precise 3D shapes like rings, frames, hooks, and clips.
- Pensa DIWire PRO – desktop machine for wire up to 6.35 mm, creating intricate designs, sculptures, furniture, jewelry, and prototypes with a max bend angle of 180 degrees.

Comparing the presented machine with above machines, we can find the below:

- all the above-mentioned machine are CNC and the presented machine is CNC,
- the machines can bend both 2D and 3D and the presented machine can bend 2D and 3D,

Table 2. Feeding results

Feed rate (mm/min)	Requested length (mm)				
	20	40	60	80	100
3000	19.95	39.83	59.7	80.05	100.1
6000	19.95	39.8	59.8	80	100.1
9000	19.98	39.9	59.9	80	100.2
Average	19.96	39.84	59.8	80.01	100.13
Error	0.2%	0.4%	0.4%	0.002%	0.001%

Table 3. Bending angle without wire

Feed rate (mm/min)	Targeted angle (°)			
	30	60	90	120
3000	30.5	59.8	90.1	120
6000	30.4	60.2	90.3	120.2
10000	30.4	60.3	90.3	120.3
Average	30.43	60.09	90.23	120.16
Error	0.6%	0.9%	0.77%	0.83%

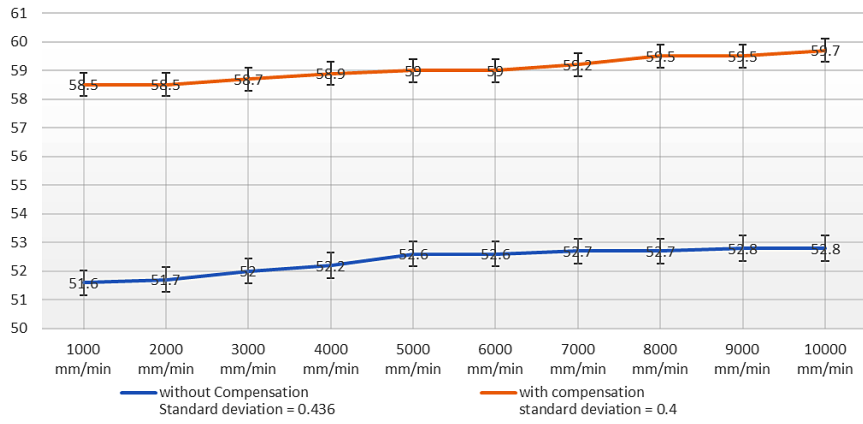

Figure 11. Aluminum wire 60° angle with and without Sb compensation

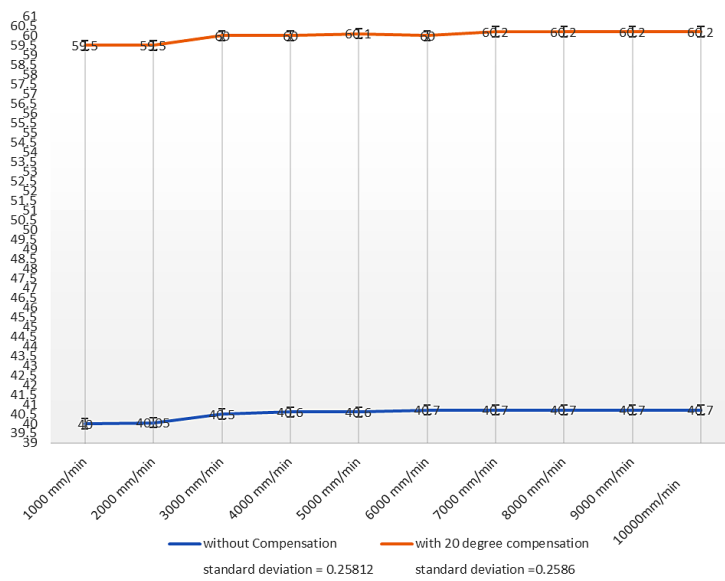

Figure 12. Steel wire 60° angle with and without compensation

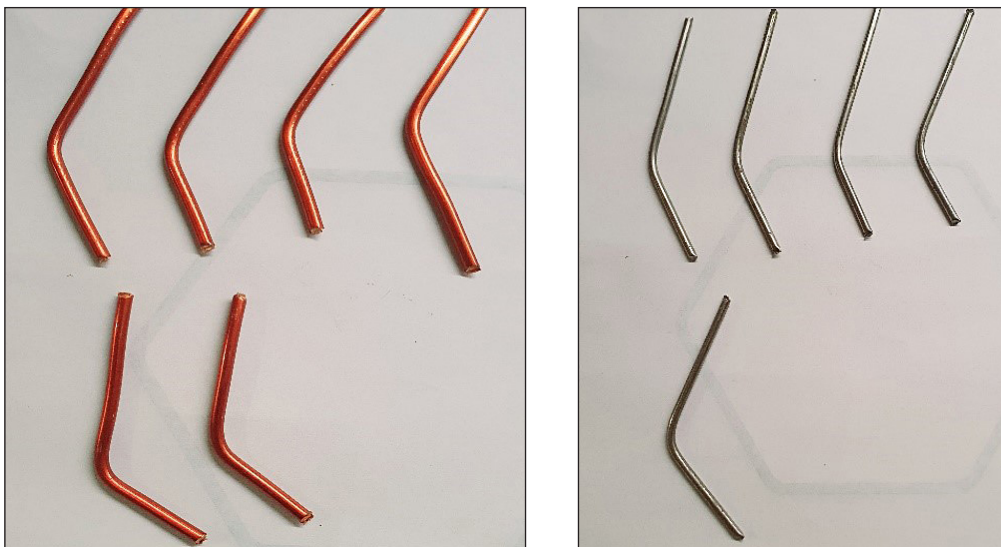

Figure 13. Steel and copper: copper wire, specimens, steel wire

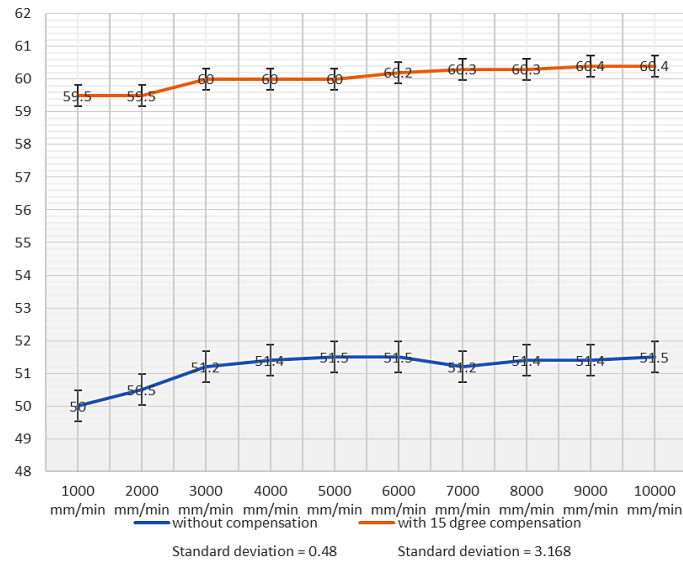

Figure 14. Copper wire 60° angle with and without compensation

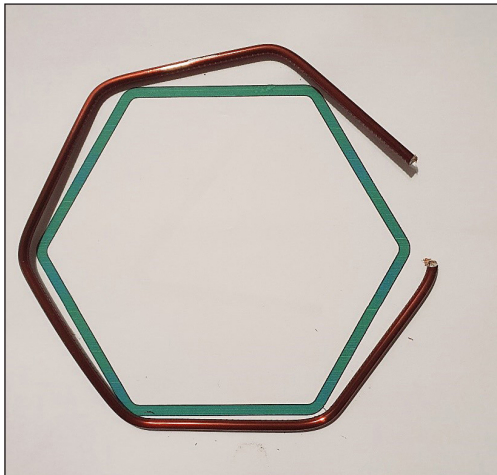

Figure 15. Test without springback and setback with bend allowance compensation compared to CAD model

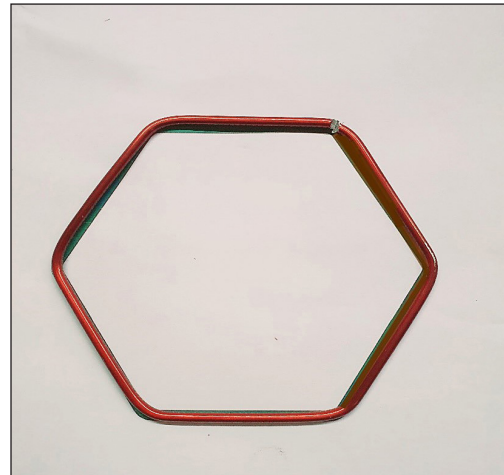

Figure 16. Hexagonal shape product with all compensations compared to CAD model

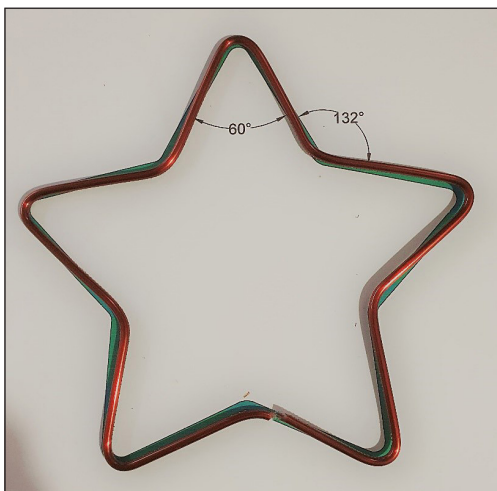

Figure 17. Star shape product with compensation compared to CAD model

- the machines can handle different wire sizes and material and the presented machine can handle different sizes and material; however, the range is smaller as it is prototype.

The machines have additional accessories like welding and cutting while the presented doesn't have but its design is customizable and such accessories can be added. In terms of accuracy the testing and evaluation of the presented machine shows high levels. Finally, the cost of the above-mentioned machine is very expensive while the presented machine in not expensive make it good choice especially for small scale manufacturers.

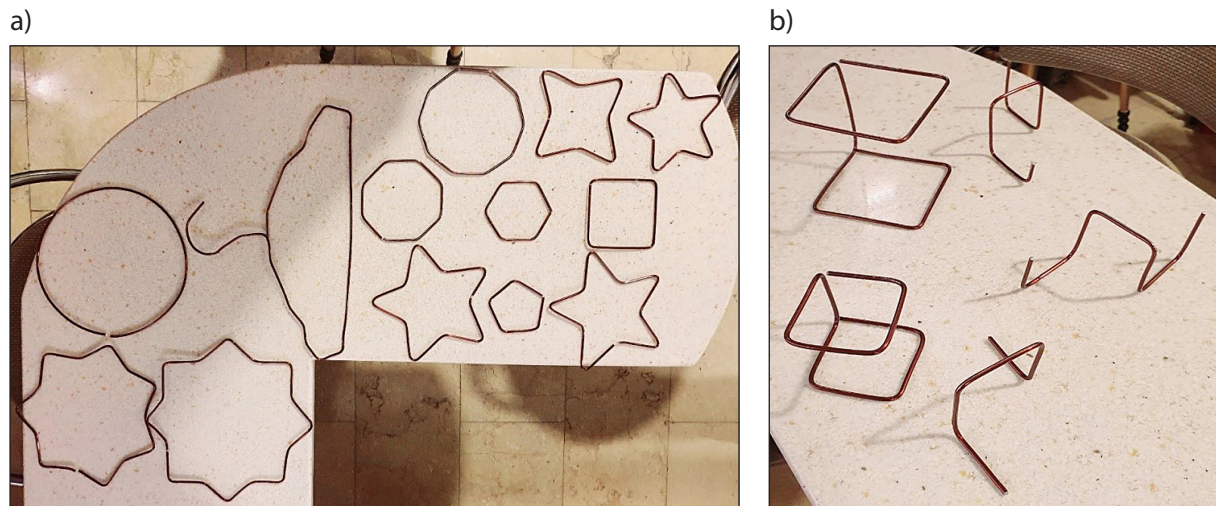

Figure 18. Some of machine product (a) 2D, and (b) 3D

CONCLUSIONS

Our investigation into the performance of the flexible wire bending machine revealed consistent and precise bending capabilities across various shapes and 3D geometries. The machine demonstrated remarkable efficiency in handling complex designs and thus confirming the success of our design approach. Despite the overall success, it is important to acknowledge certain limitations. The machine was designed to handle a small to medium scale products, it is work in a limited range of speed for both handling and bending wires and the need for periodic calibration were identified as areas for improvement. In addition, there are some three-dimensional products which may cause a collision with the machine body when its size is somewhat large. The presented machine can be used for freeform applications taking in consideration the limitation in the above-mentioned point.

It is essential for high accuracy production considering the material properties and bending process requirements such as the spring back effect compensation and bend allowance with set-back compensation effect. Without these requirements the wire bending process will face a lack in accuracy for the final product despite the precision that the machine control system can provide. Reflecting on the design process, we encountered challenges in balancing speed with precision and ensuring the adaptability of the machine without compromising stability. Iterative design, rigorous testing, and valuable feedback played pivotal roles in refining the machine's functionality.

REFERENCES

1. Shah A.K., Kumar N., Vignesh M., Khanna P. Design and fabrication of automatic rebar bending machine. 2018 Int. Conf. Comput. Power Commun. Technol. GUCON'2018. 2019; 1010–1013.
2. Murata M., Kuboki T. CNC tube forming method for manufacturing flexibly and 3-dimensionally bent tubes. Springer-Verlag Berlin Heidelberg 2015.
3. Lavrič H., Bugeza M., Fiser R. Novel approach to closed-loop control of wire bending machine. Proc. Int. Conf. Power Electron. Drive Syst. 2011; Dec.: 1100–1105.
4. Tang W.X., Zhu H., Zhu M.X., Li Q.F., Zhang J. Research on key technology of wire-bending and equipment development. Manag. Sci. Eng. 2016; 10(1): 14–20. Available from: www.cscanada.net www.cscanada.org [url:http://www.cscanada.net/index.php/mse/article/view/8212](http://www.cscanada.net/index.php/mse/article/view/8212) DOI:<http://dx.doi.org/10.3968/8212>
5. Liu R., Wan W., Isomura E., Harada K. Metal wire manipulation planning for 3D curving - A low payload robot that uses a bending machine to bend high-stiffness wire. IEEE Int. Conf. Intell Robot Syst. 2022; Oct.: 8926–8931.
6. Abd El-Aty A., Guo X., Lee MG, Tao J, Hou Y, Hu S, et al. A review on flexibility of free bending forming technology for manufacturing thin-walled complex-shaped metallic tubes. Int. J. Light Mater. Manuf. 2023; 6(2): 165–188. <https://doi.org/10.1016/j.ijlmm.2022.09.007>
7. Gaspar M., Silva FJG, Pinto AG, Campilho RDSG. 2D and 3D wires formability for car seats: A novel full-automatic equipment concept towards high productivity and flexibility. Machines. 2023; 11(3).
8. Goto H., Ichiryu K., Saito H., Ishikura Y., Tanaka Y. Applications with a new 6-dof bending machine in tube forming processes. Proc. JFPS Int. Symp. Fluid Power. 2008; (7–1): 183–188.