



Cast Grates Used in Heat Treatment Furnaces

B. Piekarski^{a, *}, A. Drotlew^b

^a West Pomeranian University of Technology, Szczecin, Al. Piastów 17, 70-310 Szczecin, Poland

^b Przedsiębiorstwo Usług Odlewniczych POLCAST Sp.J., Al. Piastów 19, 70-310 Szczecin, Poland

* Corresponding author. E-mail address: bogdan.piekarski@zut.edu.pl

Received 18.04.2019; accepted in revised form 14.06.2019

Abstract

Examples of cast grates whose construction was based on previously used "old" patterns of the technological equipment for heat treatment furnaces (TEq) are presented. Manufacturers of this type of castings have at their disposal numerous earlier designs of the applied TEq. Their adaptation for the needs of a new order, i.e. the creation of a new design or modification of the already existing one, significantly reduces both cost and time of the implementation. It also allows making new grate constructions of various shapes and sizes, reducing in this way the number of patterns stored by the manufacturer of castings. The examples of cast grates shown and discussed in this study document the variety of ways that can be used when making them from the already existing patterns or castings. The presented grates were made using master patterns, entire castings or their fragments, and modular segments.

Keywords: Innovative foundry Technologies and materials, Castings for heat treatment plants, Grates

1. Introduction

Described in general terms, the technological equipment for heat treatment furnaces (TEq) consists of a frame on which a batch of parts subjected to heat treatment is resting and is transported inside the furnace chamber and outside this chamber in the space of the production hall. The main elements of this equipment usually include a large grate that is the base of the frame and various types of spacers, mainly smaller grates, serving as shelves. After their assembly with the base, they form a frame skeleton. The wide range of heat-treated parts and the multiplicity of types and sizes of furnaces demand a wide range of TEq. Therefore manufacturers of this type of castings have a large number of patterns of grates collected during long-term production [1–6].

The majority of TEq components are castings made in sand moulds, mainly from creep-resistant austenitic Cr-Ni and Ni-Cr steels. Nickel alloys are also used when the temperature in the

furnace working chamber exceeds 1000°C, the temperature of 1250°C being the maximum temperature at which TEq components made of metallic materials can work. Castings during operation undergo degradation mainly as a result of the processes of creep, aging, high temperature corrosion and thermal fatigue [6, 8, 9].

This study gives examples of grates designed from patterns previously used in the production of castings, as well as grates assembled from modules. Both were developed under the projects already completed. The reasons for which the grate manufacturer decides to use the presented solutions in the process of designing/making new grates are several and include: making the offer more attractive as a result of the reduced cost and/or shorter lead time, full use of the available production potential during the implementation of currently executed orders, improving employees' design/production skills.

The grates discussed in this study were made using:

1. Master patterns.
2. Entire castings or their fragments.

3. Modular segments.

2. Casting of grates

The grate is usually an openwork and thin-walled structure. Its shape and dimensions are adapted to the shape and dimensions of the chamber of the heat treatment furnace currently in use and to the expected maximum mass of the heat-treated parts laid on it. Grates have the shape of a square, rectangle, circle, or a cyclic polygon (Figs. 1, 5 and 6). The height of the grates ranges from 30 to 60 mm.

2.1. The use of a master pattern

The technology of making foundry patterns from a master pattern consists of two stages. First, a wooden pattern or a pattern made of a polymeric material is made, and in this pattern a double contraction, i.e. the contraction of the metal used for the pattern and the contraction of the metal used for the casting, is taken into account. Then the proper metal pattern is cast, usually from an aluminium alloy.

The following example (Fig. 1) shows how, using the already existing master pattern, a longer grate has been made.

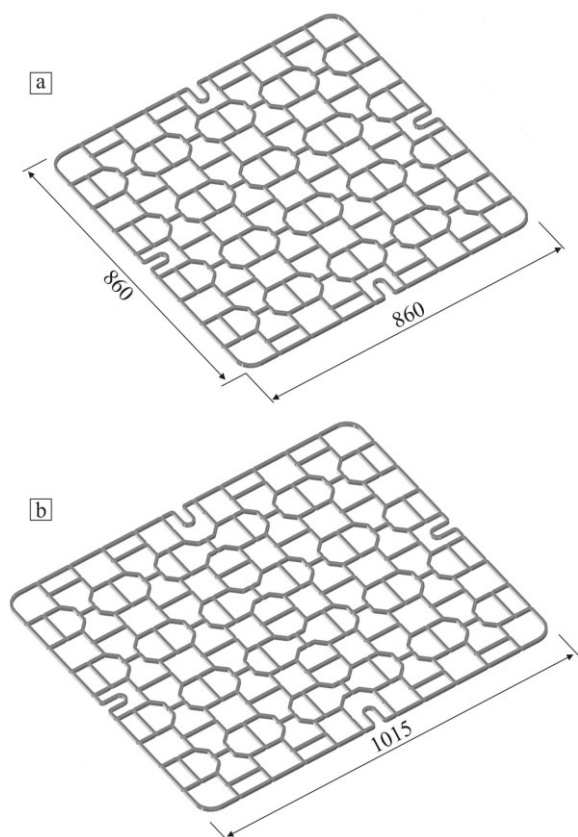

Fig. 1. Grate: a) square shape; initial dimensions, b) rectangular shape after modification

Using the master pattern previously designed (Fig. 1a), two metal castings were made (Fig. 2, parts 1 and 2). Five fragments were cut out of them (Fig. 2) and were next joined by welding to produce a new model of the grate.

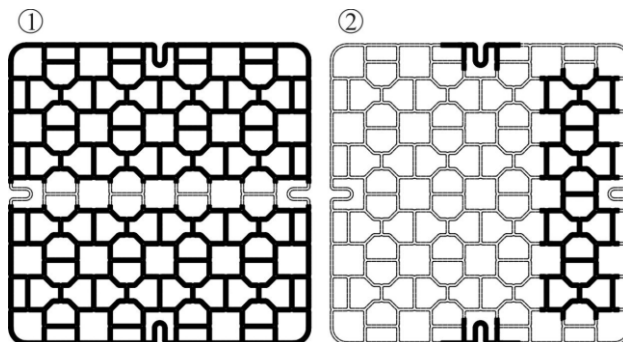

Fig. 2. Grates reproduced from the master pattern with fragments (marked in bold) used to produce the proper pattern (Fig. 1b); description in the text

2.2. The use of an entire cast grate or its fragments

Grate patterns at the manufacturer's disposal enable making castings of larger dimensions by welding them or using screw connections (Fig. 3). This procedure requires additional preparatory work. In the case of welding, the first step is to remove the draft from the contacting external edges of the grates. When disjoint connections are used, the grate pattern must be provided with a technological allowance at the joining points which will allow making appropriate recesses in the cast material (Fig. 3b). A practical solution is in this case the use of a tongue-and-groove connection.

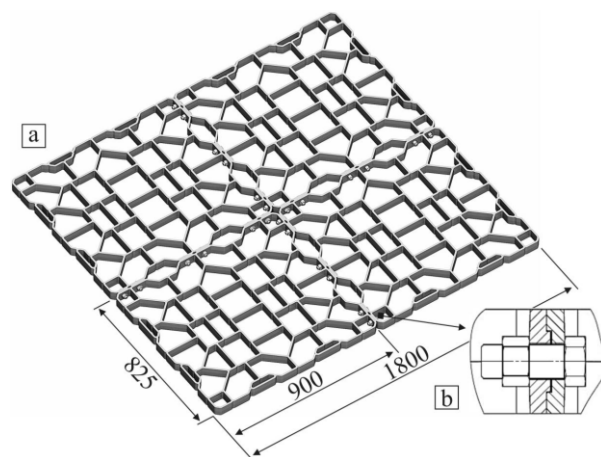

Fig. 3. Rectangular grate joined with screws: a) general view [7], b) method of joining grates

In general, casting an openwork structure of large dimensions is easier and cheaper when the whole element is divided into smaller parts. This definitely facilitates the moulding process and

increases the chances of making a high quality casting by reducing the risk of the occurrence of large internal defects such as shrinkage porosity, shrinkage cavities and hot cracks (a large number of hot spots is inevitable in the construction of these castings). The above mentioned defects accelerate the process of casting damage under the conditions of thermal fatigue and high-temperature corrosion [6, 8, 9].

The use of disjoint connections in the construction of a large grate composed of smaller grates is a more expensive solution, but also a more advantageous one because:

- it enables easier replacement of those grate components that have been worn out for a variety of reasons,
- the grate components gain additional freedom when they change their dimensions due to cyclic changes in the TEq operating temperature.

Joining of grates (Figs. 4 and 6) is also applicable when the user wants to increase the loading capacity/stiffness of the grate used so far.

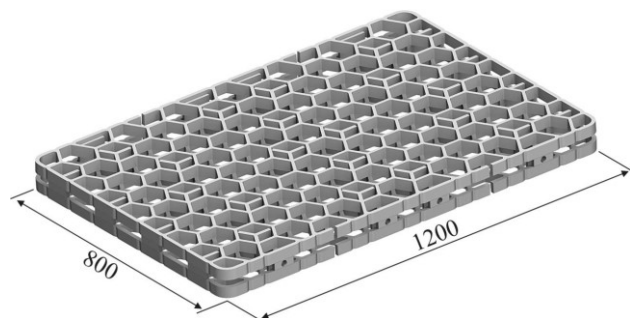

Fig. 4. "Thick" rectangular grate composed of two thinner grates

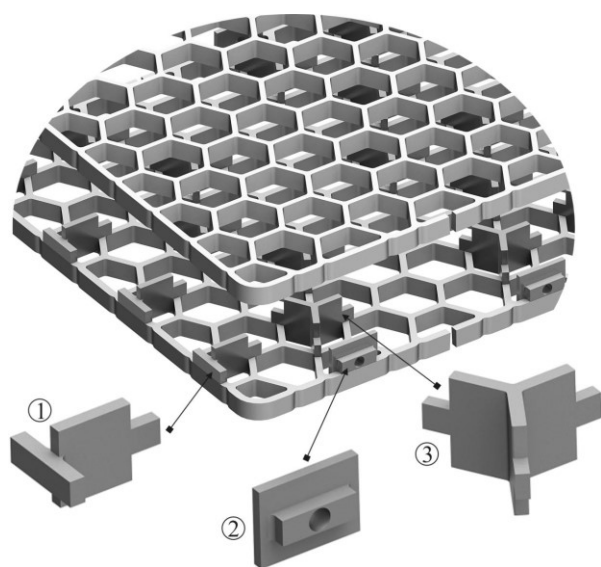

Fig. 5. Components of the "thick" grate (see Fig. 4); description in the text

In an ideal situation, when the grate is loaded with the heat-treated components, it contacts the ground with its entire underside surface. In practice, however, this situation happens rather rarely. Grates usually rest on tracks or special racks

providing point support. Quite often, the furnace shaft cannot provide even support either. In such cases, when the bottom of the grate does not evenly adhere to the substrate, its structure is subjected to the effect of the arising bending moment.

In the structure made of two locally connected grates (Figs. 4–6), the top grate on which the load is placed is supported in a uniform manner by the lower grate. Additionally, the local increase in height contributes to the increased bending strength index in cross-sections, at the points of contact between two grates, and thus to the reduction of normal stresses in these cross-sections [10].

To assemble two grates into one whole, distance pieces connecting them pointwise were designed (Figs. 5 and 6b).

The distance pieces were cast using wooden patterns and were subjected to the required mechanical treatment. Their number was as follows:

- grates (Fig. 5) No. 1 and No. 2 – 8 pieces each, No. 3 – 18 pieces,
- grates (Fig. 6) No. 1 – 37 pieces, No. 2 – 20 pieces, No. 3 – 13 pieces and No. 4 – 7 pieces.

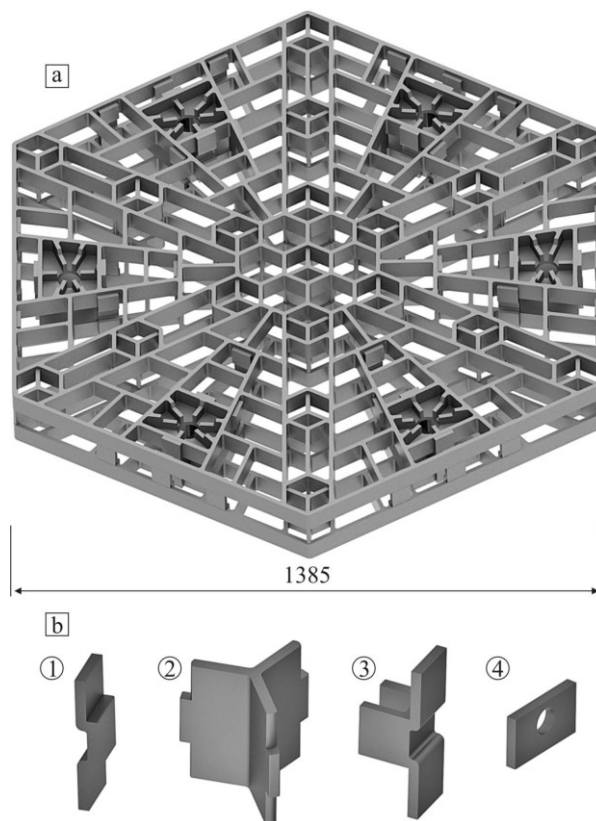

Fig. 6. "Thick" polygonal grate composed of two thinner grates: a) general view, b) distance pieces; description in the text

In the process of making grates with the customized shape and dimensions, the use of existing patterns or castings made from these patterns can reduce the whole process to only two operations, i.e. proper cutting and then joining by welding. Openwork design facilitates the welding operation. The degree of complexity of the activities involved may be either relatively

simple, when a fragment of the grate is removed by two straight cuts (Fig. 7a) and the remaining components are joined together (Fig. 7b) or more complicated (Figs. 8 and 9), depending on the expected shape and dimensions of the grate.

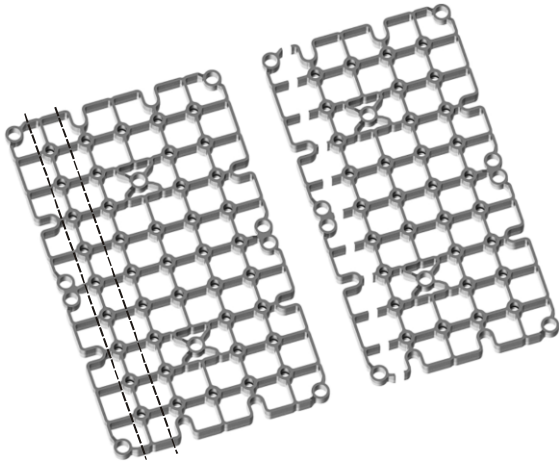

Fig. 7. Rectangular grate: a) initial shape, b) shape after cutting

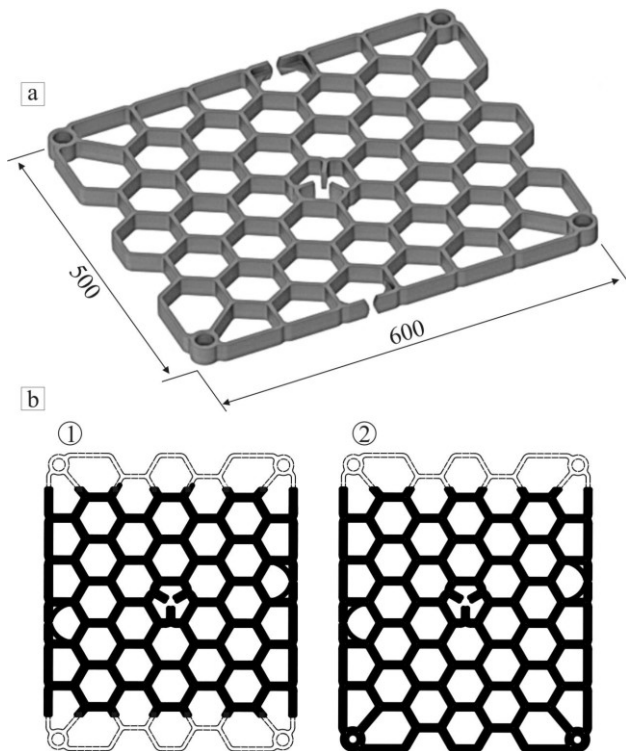

Fig. 8. Rectangular grate: a) initial shape and dimensions, b) fragments of the base grate used for assembly

Making the grate shown in Figure 9 required welding of three components together. The extreme parts of the grate (Fig. 9) were cut out from the first two castings (Figs. 8a-2), while the middle component was cut out from the third casting (Fig. 8b-1).

TEq assembled from the base grate and intermediate grates using posts and spacers is the most traditional and the most commonly used construction of this type (Fig. 10). The space between intermediate grates can be additionally supplemented with various types of hangers to facilitate the placement of heat-treated parts [3, 4, 6, 7].

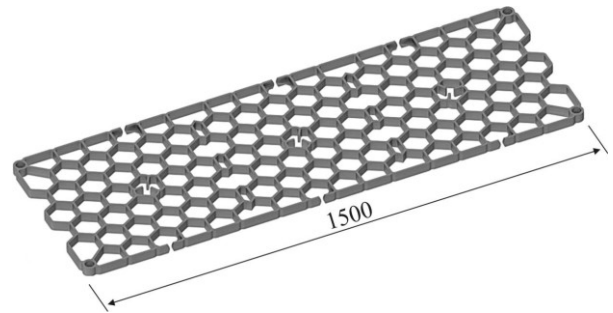

Fig. 9. Extended grate (see Fig. 8)

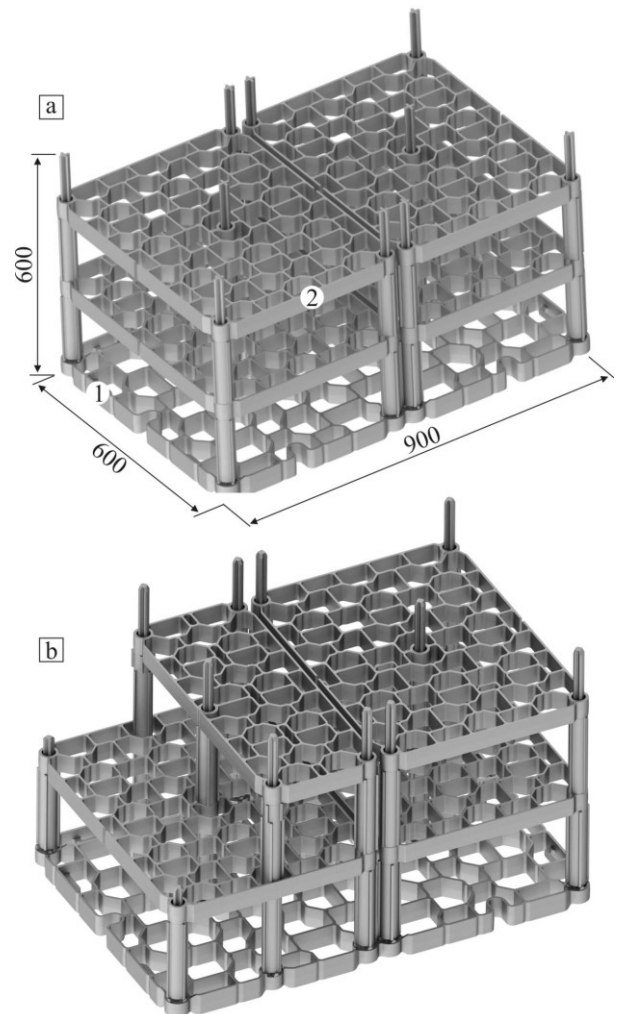

Fig. 10. Support frame (a set of components) – multilevel TEq: a) base structure [7], b) structure after modification

The support frame (Fig. 10a) already used by the customer required modification of its construction because the range of heat-treated parts has been widened. Changes were also introduced to the design of the base grate (1) and to one of the intermediate grates (2) (see Fig. 10a-b).

In the base grate, two of its fragments with a U-type stress relieving bend were replaced by fragments with a hole for attaching the post (Fig. 11a and b). Unnecessary fragments were removed by cutting them out from the grate and were replaced with new parts fastened by welding. The parts were obtained by casting using pattern printed on a 3D printer representing the fragment of the grate with an opening.

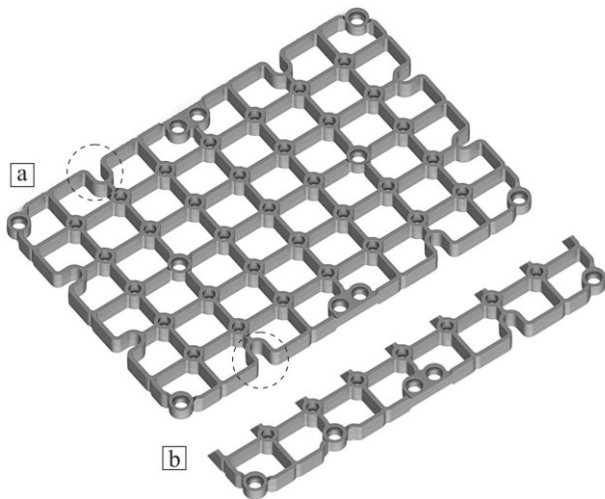

Fig. 11. The base grate in the set shown in Figure 10: a) the shape before modification, b) the outer edge of the grate after modification – the U-type stress relieving bend has been replaced with a hole for attaching the post

The required new shape of the intermediate grate (Figs. 10b and 12b) was obtained by joining the outer parts of the grate.

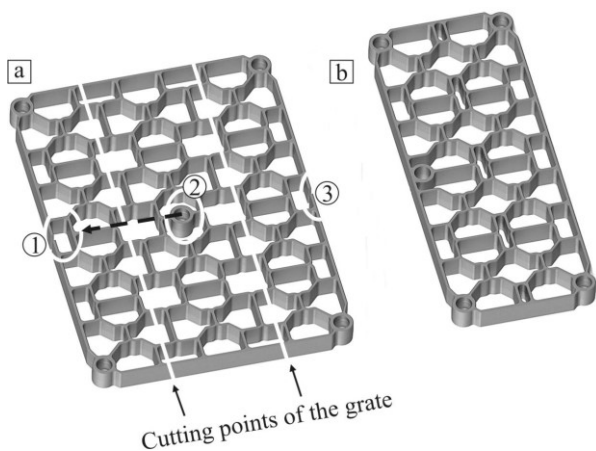

Fig. 12. The intermediate grate in the set shown in Figure 10: a) the shape before modification, b) the shape after modification; description in the text

The casting of the grate was cut (Fig. 12a). The fragment with a hole for attaching the post (2) was cut out from the central part and welded in place (1). The dilatation (3) was removed and the two extreme parts of the grate were joined together by welding (Fig. 12b).

2.3. The use of modules

The challenge for some manufacturers of machines and industrial equipment is to standardize the individual components of their products in such a way as to enable the manufacture of finished products from standard modules combined in different ways. Using modular constructions means faster assembly. Additional benefits include shorter production time and lower costs. Modularization, however, also means engineering challenges and the need for a new look at the product structure (in this case the TEq design), product commissioning and its further use.

Considering their shape, also grates can be composed of modular elements (Figs. 13 and 14).

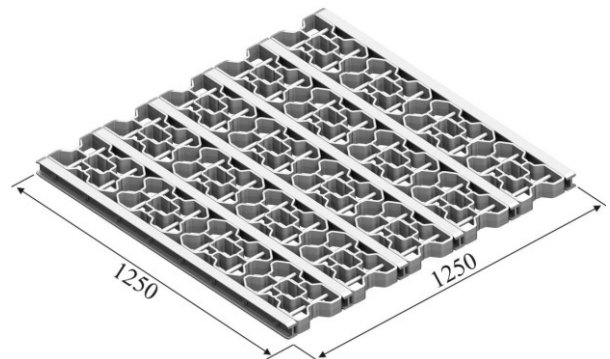

Fig. 13. Grate composed of modules

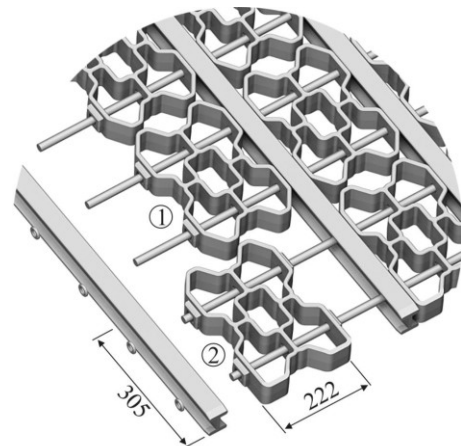

Fig. 14. Components of a modular grate structure (see Fig. 13); description in the text

The grate shown in Figure 13 consists of the following components (Fig. 14):

- cast components with openwork structure and I-sections,

– drawn bars and washers.

Due to their position, the outer openwork elements (2, Fig. 14) slightly differ in shape from the internal elements (1). The stability of the structure is ensured by the cooperation of grooves, located on the external surfaces of modules, with the appropriate edges of I-sections, which constitute the construction base for the entire grate.

Initially, the grate was designed as a structure, the length of which depended on the number of modules laid along rods of an appropriate length. Currently, by changing the construction of I-sections (Fig. 15), the grate can be extended both lengthwise and crosswise.

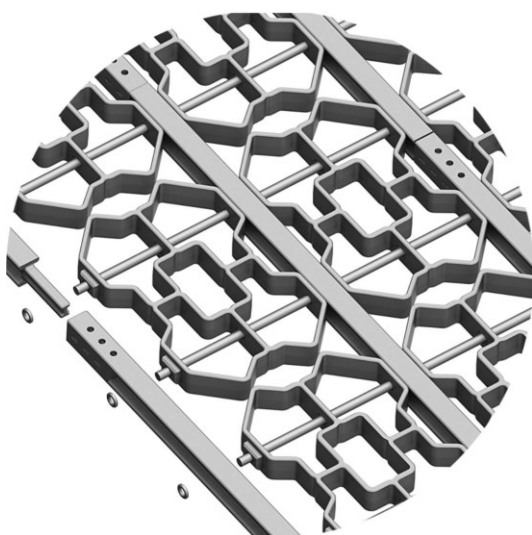

Fig. 15. Modular grate. The structure of the beam allows the grate to be expanded also crosswise; description in the text

3. Final remarks

Currently, a large number of inquiries for the manufacture of parts of machines and equipment requiring heat treatment have been placed on the Polish market. They are characterized by a large variety of parts and the requirement of a short delivery time. These factors force heat treatment plants to maximize the use of the available furnace working space. The use of TEq of a universal construction in furnaces gives savings during purchase, but it does not guarantee the maximum use of the furnace working space or the permissible loading capacity of TEq during operation. It is therefore more advantageous to use TEq whose shape and dimensions are dedicated to precisely defined heat-treated parts [6].

The process of making the appropriate TEq is usually long. Its various stages include:

1. Determination of prerequisites.
2. Elaboration of the TEq design and its approval by the contracting party.
3. Development of technological documentation for TEq components.
4. Implementation of foundry patterns, including master patterns.

5. The casting of TEq components and their machining, finishing, stress relieving, cleaning, etc.

Some of the TEq preparation steps mentioned above can be shortened to an acceptable time devoted to their implementation. The solid design is currently a standard procedure, because 3D drawings are necessary in further stages of the TEq manufacture (see items 3–5). The use of 3D printing accelerates the implementation of master patterns. Unfortunately, this applies only to elements of small and medium size. The benefits of using a 3D printer are the higher, the more intricate is the component. Unlike other manufacturing techniques, this method of manufacturing parts is not sensitive to the degree of their complexity. In foundry practice, the 3D printing method is most useful for making master patterns of parts of core boxes and small intermediate grates, and also parts of base grates, if they include repeatable elements.

To sum up it can be stated that the search for solutions that can reduce the time of making new TEq is a political necessity. Generally speaking, the whole matter consists in configuring new TEq solutions using fragments of the existing solutions and combining them in different ways. By doing so, it becomes possible to shorten the time necessary to implement steps 2–4 and almost omit step 3 of the production process mentioned above.

References

- [1] Steinkusch, W. (1987). Heat-resistant cast steel for heat treatment plants. *Gas Waerme International*. 6, 340-346. (in German).
- [2] Steinkusch, W. (1985). Improved materials and designs reduce operating costs during heat treatment. *Fachberichte Hütten. Metall*. 23, 746-749. (in German).
- [3] Folders: Lohmann, Cronite, Pose-Marre, Technoalloy, MANOIR PETRO-CHEM, AFE Technologies, NCK.
- [4] Lai, G.Y. (2007). *High-Temperature Corrosion and Materials Applications*. Publisher: ASM International.
- [5] Davis, J.R. (Ed.) (1997). *Industrial Applications of Heat-Resistant Materials*. In Heat Resistant Materials ASM International. 67-85.
- [6] Piekarski, B. (2012) *Casting from creep resistant alloys in furnaces for heat treatment*. Szczecin: Publisher ZUT Szczecin. (in Polish).
- [7] Drotlew, A., Piekarski, B. & Słowik, J. (2017). The design of cast technological equipment for heat treatment furnaces. *Archives of Foundry Engineering*. 17(3), 31-36.
- [8] Bajwoluk, A. & Gutowski, P. (2017). The Effect of Cooling Agent on Stress and Deformation of Charge-loaded Cast Pallets. *Archives of Foundry Engineering*. 17(4), 13-18, DOI: 10.1515/afe-2017-0123.
- [9] Bajwoluk, A. & Gutowski, P. (2019). Stress and crack propagation in the surface layer of carburized stable austenitic alloys during cooling. *Materials at High Temperatures*. 36(1), 9-18. DOI: 10.1080/09603409.2018.1448528.
- [10] Dyląg, Z., Jakubowicz, A.S., Orłoś, Z. (2013). *Strength of materials*. Warszawa: WNT. ISBN: 978-83-7926-069-0. (in Polish).