

Hisayoshi SATO¹

MULTIPLE REGENERATIVE EFFECT GOVERNING CHATTER BEHAVIOUR AFTER ONSET

Chatter is the self-excited vibration that occurs during cutting. The entire structure of a self-excited vibration comprises two core mechanisms, i.e., stability limit and sustained vibration with finite amplitude after onset. The latter mechanism remained unnoticed until the discovery of the multiple regenerative effect (MRE) in 1980. However, its effects have not yet been recognized correctly. This paper summarizes the problems that could be resolved by considering the MRE in the analysis from the theoretical and practical viewpoints. In conventional stability limit analyses, tool traces never intersect; however, after the onset of chatter in an actual system, traces immediately intersect. This results in tool-workpiece separation, chip thickness variation during the separation period, and chip breakage. A solution for equation of motion considering the MRE agrees well with chatter behaviour in actual applications. In addition, the solution yields the phase relationship between the displacement of work motion and the cutting force, although this relationship is not considered in the equation of motion. Further, the relationship between the penetrating cutting speed and the resistive force, confirmed experimentally, is introduced in equation of motion, which verifies the widening of the stability region at low cutting speeds.

1. INTRODUCTION

Den Hartog pointed out that “chatter,” the vibration generated during cutting, would be self-excited after the difference between the definitions of self-excited vibration and forced vibration was clarified [1]. Doi skilfully observed and measured chatter behaviour in turning using self-assembled optical equipment, but he misunderstood the behaviour of forced vibration [2], thus resulting in wrong identification of vibration characteristics. However, he is to be honoured because his paper was the first academic publication on self-excited vibration in cutting using an engine lathe. There is a voluminous and profound book on vibration in Japanese by Sezawa [3], which was published two years earlier than the book by Den Hartog. Sezawa did not clearly point out self-excited vibration, did not describe “chatter” and the definitions of forced vibration and self-excited vibration were not clearly distinguished; however, wing foil flutter was shown as an example of self-excited vibration in a manner similar to that in the book by Den Hartog. If Doi knew about the book by Sezawa or Den Hartog, he should have been careful in arriving at the conclusion. Den Hartog’s book was translated by Taniguchi and Fujii [4], but this was entirely done later in 1960.

¹ University of Tokyo

However, if Doi did not know about these books, knowledge on self-excited vibration in 1930s was not widely informed as it was in 1950s after the World War II.

After Doi's conclusion in his Japanese paper that the vibration was of the forced type, a paper on self-excited vibration by Arnold, published in Proc. IME in 1946 soon after World War II [5], referred to the paper in Japanese by Doi. However, Doi appeared to take time to understand that what he observed was self-excited vibration. At one time Fujii, supervisor of Sato's thesis for Dr. Eng., at graduate school, University of Tokyo (UT), told Sato about his conversation with Doi. In this conversation, Doi told Fujii that he could not understand the behaviour of the vibration he observed in his first paper, but, nonetheless, concluded it was forced vibration. Fujii, who was an expert on self-excited vibration in relation to surging of centrifugal pump systems [6], immediately pointed out that the phenomena could be self-excited vibration. This opinion convinced Doi that whatever he observed was not forced vibration but self-excited vibration. Recalling the scenario of Fujii's story, Sato presumed that the talk between Fujii and Doi probably happened between 1950 and 1955, when the academic atmosphere was enthusiastic about self-excited vibration in relation to nonlinearity.

Under Fujii's supervision, based on achievements related to the surging of centrifugal pump systems [6], self-excited vibration was actively investigated in the 1960s by graduate students wishing to study thermal fluid dynamics. These investigations include the singing flame by Saito [7] and the boiling water in a channel by Hayama [8]. Fujii indicated the importance of gaining insight into the phenomenon of self-excited vibration through the true physics of its mechanism [9]. Sato's M.E. thesis at UT was not as tough as the subjects described above, but still related to self-excited vibration nonetheless, "*Stabilization of self-excited vibration by additive input*," [10].

As in the descriptions of Den Hartog's book and in various papers on the topic [6-9], investigations of self-excited vibration were concerned with the following two core mechanisms that constitute the entire structure of self-excited vibration: mechanism of stability limit analysis and mechanism of sustained vibration with finite amplitude. The abovementioned investigations concluded that the two core mechanisms occurred concurrently and not independently because of nature of the self-excited vibration system. However, in studies on chatter, the first core mechanism has long been concentrated upon, whereas the second core mechanism, the importance of which remains underestimated, has largely been ignored. Views in favour of and against the claims made thus far are presented in the following text.

Results of active investigations on the first core mechanism, i.e., stability limit, were published from the middle of 1950s to the middle of the 1960s by Tobias and Fishwick, Peters and Vanherck, Tlustý, and Merritt [11-14]. Stability limit analyses were carried out only from the viewpoint of the first core mechanism. Therefore, the basic system equation was found to be effective even without consideration of vibration sustainability after the onset of chatter. In addition, scholars were not concerned with the analysis of sustained vibration after chatter generation and were not well informed about the structure of self-excited vibration. This is attributed to the fact that they were experts on manufacturing, and there was a strong belief that investigating the mechanism of vibration sustainability after chatter generation is futile in view of the case in which the work cannot be used as

a practical part owing to chatter marks. In fact, Tlustý dismissed investigations of the topic as a nonsensical endeavor in a talk with Sato during the 1974 GA CIRP in Japan. In contrast, Kegg, who published paper on chatter [15], replied to same subject stating that if an analysis on chatter after onset were possible, the decision to continue with or stop machining would be made in advance by the production management personnel on the shop floor. This was a comprehensive suggestion by an expert who well understood the practical resolution of this unsolved problem.

Papers on stability limit analysis published around 1965 were concerned with identification of the stability limit, and each investigation derived equivalent resolutions; but a period passed without deriving essentially meaningful and fruitful results for the next stage of development pertaining to the problem at hand. One reason behind this could be the concept presented by Tlustý, i.e., investigations on the fact that a work is rendered useless from the practical viewpoint owing to chatter marks is futile, which neglected the importance of comprehending the entire structure of self-excited vibration. Kondo et al. suggested that the second core phenomenon is governed by MRE, which is discussed in detail in the following [16],[17]. The paper [17] was translated from that in Japanese [16], which was admitted at that time by the ASME manual MS4. In the stability limit analysis, the loci of current tool motion and the previous one never intersect; however, once the state crosses over the limit, which easily takes place under the condition on the limit, both loci essentially intersect and lead to the MRE situation.

The paper describing MRE was published more than 30 years ago, so that this paper does not describe anything new. However, interest in the investigation and development of chatter-related issues for improving machine tool operational performance to avoid the occurrence of chatter seemed to have been renewed. Considering MRE, the simulation of the occurrence of chatter was made possible by solving the equation of motion in the time domain. The simulation results clarified cause and effect of the phenomena observed during chatter, which are not easy to discern. The phase relationship between cutting force and vibration motion of workpiece, which had been thought of as the cause for a long time, was found to be the effect. Assuming Tobias and Fishwick's term due to penetration of tool motion [11], the property was experimentally verified considering Kondo and others' original views; thus, the extension of the stability limit under low-speed cutting was confirmed. Although these are analyses concerning theoretical interests, the results are of practical significance for developing cutting conditions that increase productivity and avoid chatter occurrence. These features are described in the following as well.

2. DIFFERENCE OF FRF OF MACHINE TOOL STRUCTURE FOR PURPOSE OF INVESTIGATION

This subject is too natural for proficient engineers dealing with vibration in machine tools. However, the frequency response function (FRF) of a machine tool structure, referred to even in the paper that gave us an important expression for the stability limit criterion [14], did not appear to show appropriate FRF for identifying chatter problems. The FRF to

be considered depends on the purpose of the respective subjects. In the following text, the FRF dealing with machining accuracy considering chatter occurrence is compared with the FRF of the entire body of a machine tool structure as the standard.

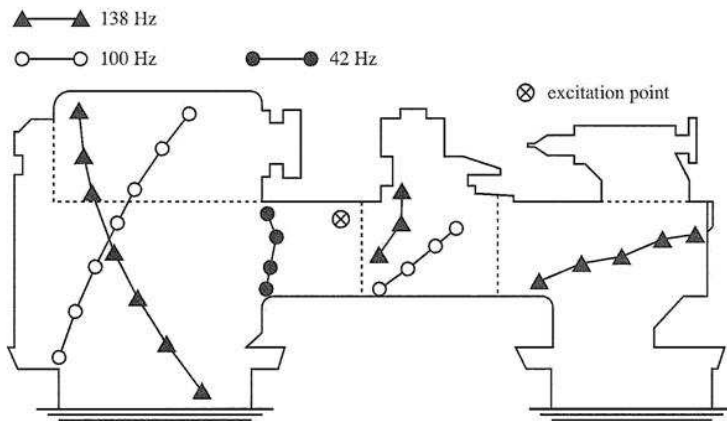

Fig. 1. Illustration of nodal lines for natural of bed for engine lathe

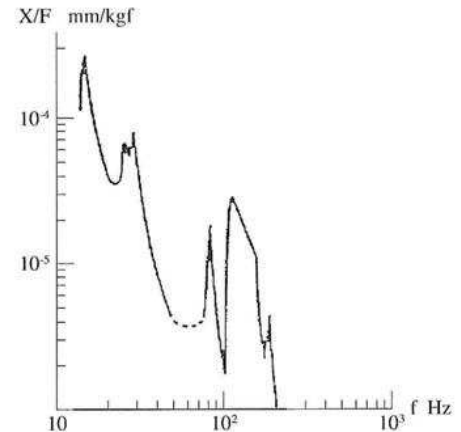

Fig. 2. Compliance at side wall frequencies of engine lathe

There are two and three nodal lines for the natural frequencies of 100 and 138 Hz, respectively. This means that there are multiple bent shapes along the bed. Although the bed structure appears stiff, it is soft and flexible considering its dynamic behaviour. There is another natural frequency lower than 42 Hz [19]. At this frequency, the entire machine tool body oscillates back and forth to position where operator stands. Although not discussed in this paper, this vibration is the first order of the natural frequency, and the so-called rocking motion is the corresponding vibration mode. The natural frequency is defined by the boundary condition related to the placement or support of the machine on the ground. It is important to note that even if the static stiffness of the bed structure appears to be sufficient, deformation along the bed at higher natural frequencies owing to dynamic stiffness will result in relative displacement between the tool post and the workpiece, which is directly related to surface roughness.

The features of the natural frequencies and the corresponding modes of vibration are specific to the fundamental shape of the engine lathe, the basic features of which can be simulated by considering a frame structure with a gate form. Therefore, for the first natural frequency, the mode of vibration of the beam connecting the columns at both ends is represented by beam movement without significant deformation; herein, both ends of the beam move with the same phase. For the second natural frequency, both ends oscillate with opposite phases, and for the third natural frequency, both ends move with the same phase and the central region is bent in a bow shape.

The phrase “vibration characteristics of a machine tool” has often been used for considering the structural vibration characteristics of either forced vibration or chatter. For the former, it is important to note the effect of the FRF on the characteristics of the entire machine body, shown in Fig. 2, in terms of compliance. The peaks shown in Fig. 2 indicate the natural frequencies of the entire machine tool structure, which is a multi-degrees-of-freedom (MDOF) system comprising the sum of single-degree-of-freedom (SDOF)

systems, whose respective peaks determined by modal analysis [20],[21]. However, if machining accuracy is to be discussed, it is important to observe the characteristics of the structure in Fig. 3, which shows the relative displacement between tool and the workpiece. The FRF is flat with peaks of the natural frequencies over the entire frequency range.

At the lowest natural frequency, vibration of the tool and the workpiece have the same phase; yet, a peak, whose amplitude is decreased to almost one hundredth, is observed. This means that even though the tool and the workpiece move with the same phase, as observed for the first natural frequency, a relative displacement occurs owing to vibration and influences the surface roughness of the machined work. This characteristic appears in machines specifically designed and assembled for super ultra-precision machining on a rocky base. In the case of the rocking mode of vibration with the same phase for tool and workpiece, the distributions of mass and stiffness are never uniform, thus leading to different vibration amplitudes and relative displacements of the two objects. These characteristics naturally change with size, structural composition, tool position, and the manner in which the excitation is induced. However, the natural frequency and mode of vibration do not change with these factors. Regarding the occurrence of chatter, the completely different characteristic shown in Fig. 4 should be considered, where the vertical axis represents mechanical impedance instead of compliance, as in Fig. 2 and Fig. 3; however, it is clear that the characteristic of the FRF is different.

When forced vibration becomes an issue in a machine tool, a primary subject is the influence of the characteristics of structural vibration in the entire structure of the machine tool on the accuracy of work on the machined surface. The extent of such influence is related to the FRF of the relative displacement between the tool and work through the FRF of the entire machine tool structure. The FRF of the entire machine tool structure is typically represented as shown in Fig. 2, and that of the relative displacement is represented as shown in Fig. 3. These functions, as mechanical impedance, and other related definitions of the functions have been summarized by Crandall [22]. The vibration characteristic is governed by *the natural frequency, mode of vibration, and damping ratio*. Figure 2 shows *the FRF in terms of compliance by forced excitation at a point on an engine lathe* [23].

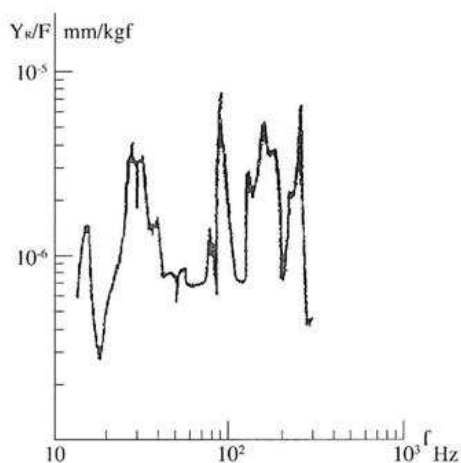

Fig. 3. Compliance for relative displacement between tool and work

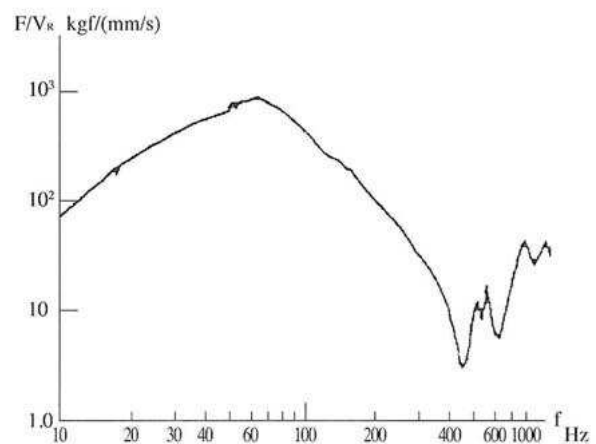

Fig. 4. Measured mechanical impedance between tool and work for simulated excitation cutting force

Regarding chatter, *the cutting process, regenerative effect, overlap factor, and structural dynamics* are considered as terms governing the system, and from which the stability limit can be derived [14]. Figure 4 shows a plot of the mechanical impedance for the relative displacement against cutting force, which is one aspect of the structural dynamics considered in the stability analysis of chatter. The peaks shown in Figs. 2 and 3 disappear, and only the natural frequency arising from the spindle-workpiece system is observed. Within the low-frequency range, characteristic of the mechanical impedance shows the property of mass. This suggests that the spindle-workpiece system will not be excited in this range, and, therefore, chatter will not occur in the mentioned frequency range. It is necessary to note that if the term “characteristic of structural dynamics” is used, the expression for the FRF differs completely depending on the purpose for which it is utilized, the correlation of vibration with accuracy in relation to forced vibration, or the stability limit analysis for chatter.

3. RECOGNITION OF MRE AND PHENOMENA BY EFFECT

Figure 5 shows the principle of MRE [16],[17], as described by Kondo et al. In the conventional analysis on identifying stability limit each trace of chatter, broken line for motion of insert which is about to cut the work in current motion, solid line for cut surface by trace of tool motion for one turn before, chain line for motion by trace of tool motion for two turns before were independently described and shown to never cross each other in any published paper before Kondo et al. [16],[17]. However, once the system merges with the unstable region, the chatter amplitudes of the respective waveforms grow, consequently they naturally intersect and the phenomena shown in Fig. 5 i.e., the state of MRE, essentially appear. The regenerative effect, which is considered in conventional stability limit analysis, is the state in which each vibration trace never crosses another. The phenomenon was pointed out by Hahn [24] and was formulated by Merritt [14]. The result of the analysis yields the machining condition under which self- excited vibration would start, but it would be component of the self-excited vibration’s structure.

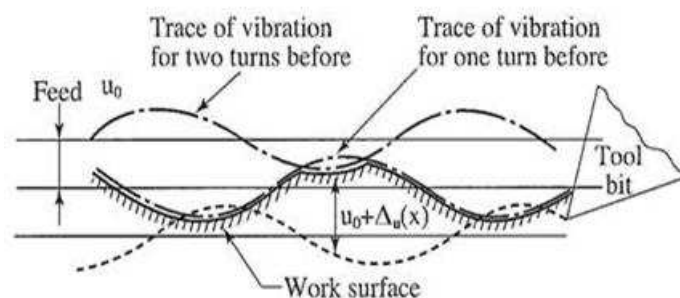

Fig. 5. MRE Principle

Furthermore, the entire structure of self-excited vibration is completed by providing another component of the structure, i.e., of structure sustained self-excited vibration with finite amplitude, an example of which is shown as by Fujii [6].

As soon as the trace of the vibration amplitude grows, the tool is separated from the work surface owing to the jumping-up motion shown in Fig. 5. This separation implies the occurrence of MRE. Furthermore, this trace clarifies that chips are formed as broken pieces without a continuous form. In addition, chip thickness is reduced, i.e. the cutting force is decreased, during a period in which the tool jumped. The cutting force, which induces the self-excited vibration, is nullified when the tool is separated from the work. Therefore, the energy supplied into the system by the cutting motion itself for exciting the chatter is dissipated during the period. Consequently, the chatter amplitude, which grows abruptly after the cutting condition merges into instability region by crossing over the stability limit, is prevented from growing infinitely and the chatter is sustained with finite amplitude. Furthermore, variation of chip thickness during separation of the tool from the workpiece reduces the cutting force and prevents infinite growth of the vibration amplitude.

Figure 6 shows the chatter behaviour of the displacement and the cutting force in the radial direction for horizontal motion of the workpiece. The cutting force is reduced to zero during the separation, which agrees with the MRE-based phenomenon shown in Fig. 5. This figure shows that there is a period in which the tool is separated from the work. To verify the MRE phenomenon, Kondo et al. equipped an engine lathe with an electric circuit for confirming contact between the tool and the workpiece [16]. It was proved that the cutting force became zero while the circuit was cut off during the separation period. The fact that the cutting force is reduced to zero was first measured and pointed out in a paper on chatter by Doi [2] in 1936. However, the theoretical feature of the phenomenon, as described above, was not clarified before Kondo et al. introduced the concept of MRE in 1980 [16],[17].

In spite of the fact that Doi measured and observed the occurrence of the separation, which was significant testimony to that the nonlinearity of piecewise linear between the displacement of work motion and the cutting force occurred, he missed this phenomena and mistook the vibration as conventional forced oscillation. noticed that the cutting force is limited to null at low amplitudes, she or he might have deduced that the separation of the tool the workpiece would have cause a reduction However, this was not the case, which means that no one was interested in the phenomenon underlying such behaviour.

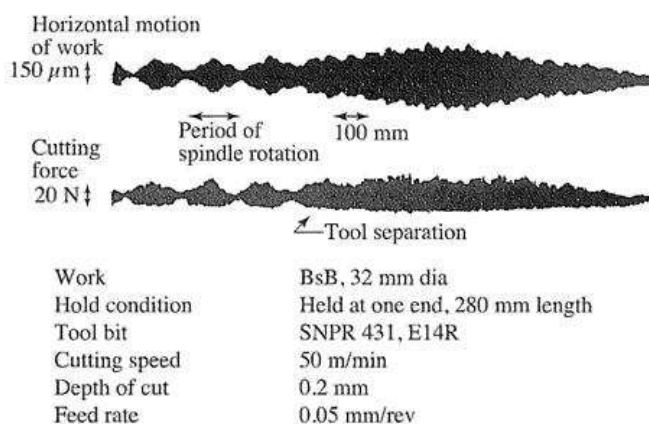

Fig. 6. Work motion and cutting force after chatter

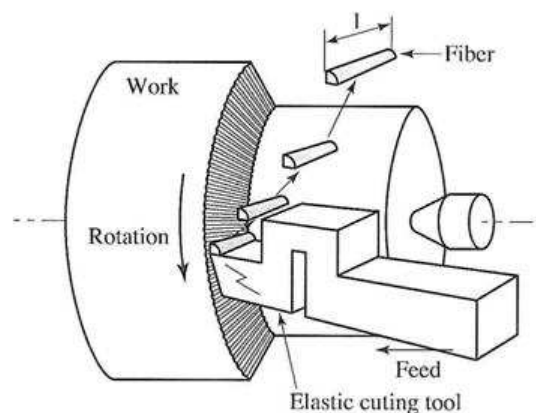

Fig. 7. Method for manufacturing fine onset short metal fibres using chatter

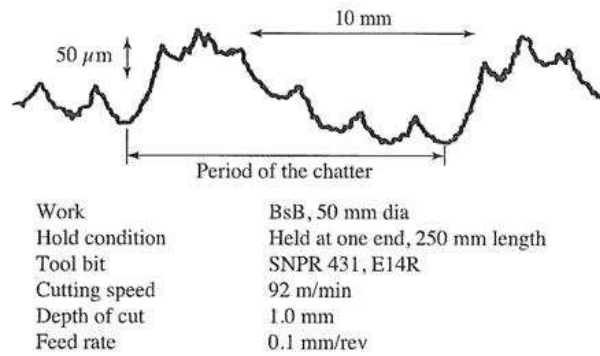

Fig. 8. Trace of surface profile after chatter onset in circumferential direction

Considering machining on shop floor, Sato knows two cases in which cutting is proceeded despite the occurrence of chatter: rough cutting of rolling rolls and cutting the edge face of pressure vessel for atomic power plants. These cases are very few, but it is true that in practical situations, machining is continued even after the occurrence of chatter, and at the cutting in these cases, MRE actually progresses.

Generally, chatter is a harmful phenomenon that should be avoided in machining because the workpiece surface deteriorates owing to chatter marks and becomes useless as a product. There is an exceptional case in which the chips that are cut and scattered into pieces by MRE are used for manufacturing short metal fiber through a process skilfully devised by Nakagawa et al. [25]. Figure 7 illustrates how short metal fibers are manufactured with a system that intentionally causes chatter by using a gooseneck type of tool. The fibers are employed in reinforced composite materials used as brake pads in cars.

Chatter marks formed during the occurrence of chatter were measured using a device developed by Mitsui and Sato for high-speed measurement of surface roughness around the periphery of bar work [26]. They evaluated the correlation between structural vibration and surface roughness and detected the waveforms shown in Fig. 8. It was found that the fundamental component of a waveform with a long period agreed with the chatter frequency, but the fact that the higher harmonics overlapped on the waveform of the fundamental component could not be understood when upon first observation using the device. It was conclusively clarified that when MRE occurs, the higher harmonics can be left as a trace in between the wavelength for chatter frequency owing to MRE.

This was clearly verified by the three-dimensional (3D) observation of the surface texture of machined work overlapped on a base cylinder, as shown in Fig. 9. Surface texture was measured using a device developed on the basis of Schmaelz's method discussed in a reference by Uchida et al. [27]. The cutting conditions are summarized in Table 1. The unfolded shape of the portion on the surface can be arranged as shown in Fig. 10, and the waveform shown in Fig. 10 is measured in the peripheral direction.

Dimples are observed in troughs between peaks resulting from the frequency of the self-excited vibration and due to the MRE; therefore, the waveform measured along the peripheral direction shows ripples superimposed on the basic chatter waveform. This solution was derived by considering MRE and setting up a device for measuring the 3D surface profile around the bar workpiece.

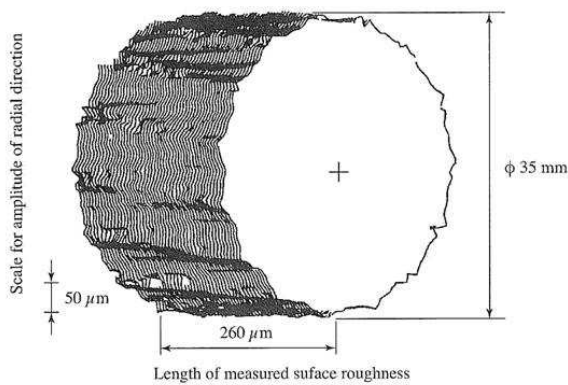

Fig. 9. 3D surface roughness of measured chatter marks superimposed on a basic cylinder

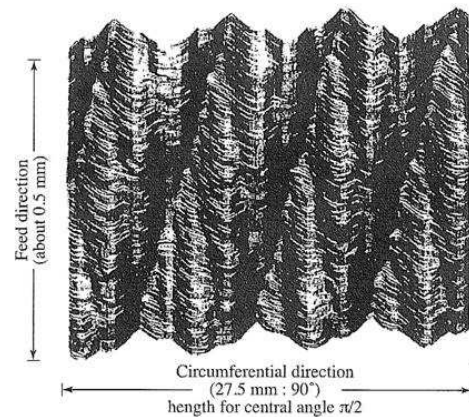

Fig. 10. 3D surface roughness of measured chatter mark displayed on plan

Table 1. Cutting conditions for measured surface shown in Fig. 10

Material	Brass
Depth of cut	1.0
Feed (mm/rev)	0.125
Cutting speed (m/min)	99
Overhang work length (mm)	250
Overhang bit length (mm)	45
Frequency (Hz)	236
Tool: Tip	Snpr 321
Tip nose radius.....	0.4 mm
Shank	E14R

Work : Held only by chuck

The phenomenon complementing the structure of the self-excited vibration, called chatter, was proposed by Kondo et al. in view of the MRE shown in Fig. 5. This was first published in Trans. JSME, and it was submitted to CIRP Ann. in 1980 on an admitted basis of submission related to the originality of the paper. However, the paper was rejected and was immediately referred to Trans. ASME. It was published in August 1981 with a date of acceptance of March 7, 1980 immediately after the rejection. The paper published in Trans. ASME studied turning by an engine lathe, a process that could effectively explain the accompanying MRE. Attending GA CIRP in 1981 in Toronto, Prof. Tlustý proudly presented a paper [28] contrary to his claim against the investigation after the onset, the core concept of which was obviously application of MRE to milling process. As soon as Prof. Tlustý finished his presentation and came into time for discussion, Sato pointed out the behavior of MRE and the chain of events beginning with the rejection, submission to Trans. ASME, subsequent acceptance. This chain of events clearly indicates that the presented paper is unoriginal because the concept presented in the mentioned paper was from another

publication (Kondo et al. [16],[17]) in Trans. ASME. However, Prof. Tlustý chose not to comment on this issue, but, instead, responded with a grimaced expression.

[Footnote] Reviewing the paper presented by Tlustý and Ismail [28], and looking back the situation passed by before the presentation, Sato was forced to doubt that the paper copied primary concept of MRE from the rejected one same as that by Kondo et al. in Trans. ASME [16],[17]. It gives strong impression that the core concept of MRE and the analytical method were transferred to milling process after rejecting the paper submitted to GA CIRP in the previous year. The paper does not use the word MRE, but uses the same phenomenon for sustaining vibration with finite amplitude after onset, and the analysis could be done in time domain, which is soluble to system with nonlinearity as well. There is an unnatural description in the synopsis that “For turning the method does not reveal any new conclusion.” The course of the events shows that the credit for MRE and the associated matters must be accorded to Kondo et al. [16],[17] and not anyone else. It is needless to say that investigations on the chatter frontier regarding MRE have been encouraged by Kondo et al.’s work.

4. ANALYSIS ON CHATTER BEHAVIOR CONSIDERING MRE

In the following text, the equation of motion considering MRE is derived. As shown in the studies of Tobias and Fishwick [11], Tlustý [13], and Merritt [14], the analysis can be conducted by restricting the motion of the workpiece in one direction. Figure 11 shows a model of the vibration system. The radial projection of the cutting force is assumed to be proportional to chip thickness.

The side cutting angle, θ , which is shown in Fig. 12, is included in the equation of motion, which is expressed as follows:

$$m\ddot{x} + c\dot{x} + kx = h\Delta u \sin \theta \quad (1)$$

where $\Delta u(x)$ is expressed as follows:

$$\Delta u(x) = [x(t - 60/\Omega) - x(t)] \sin \theta \quad (2)$$

where $x(t - (60/\Omega))$ denotes the displacement of the workpiece in the previous turn. If Eq. (2) is substituted into Eq. (1) and the expressions

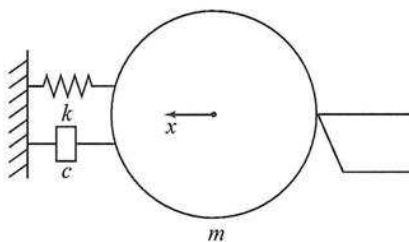

Fig. 11. Model for chatter analysis

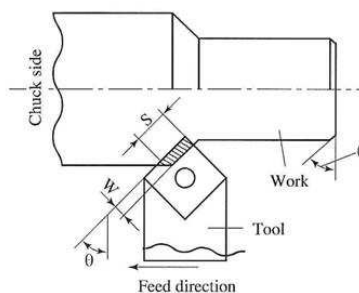

Fig. 12. Schematic of tool and work used in cutting

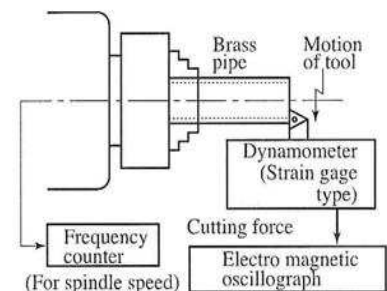

Fig. 13. Pipe face cutting through tool motion in radial direction

$$\omega_0^2 = k / m \quad (3)$$

$$\zeta = c / 2\sqrt{mk} \quad (4)$$

$$\gamma = h / k \quad (5)$$

are used, then

$$\begin{aligned} & \ddot{x}(t) + 2\omega_0\zeta\dot{x}(t) + \omega_0^2x(t) \\ & = \omega_0^2\gamma\{x(t - (60/\Omega)) - x(t)\}\sin^2\theta \end{aligned} \quad (6)$$

is obtained.

Equation 6 has been used in a previous analysis on the stability of systems. If the MRE is considered in calculating $\Delta u(x)$, then

$$\begin{aligned} \Delta u(x) = & \min\{x(t - (60/\Omega))\sin\theta, \\ & f_0\cos\theta + x(t - 2(60/\Omega))\sin\theta, \\ & 2f_0\cos\theta + x(t - 3(60/\Omega))\sin\theta, \\ & \dots \\ & (n-1)f_0\cos\theta + x(t - n(60/\Omega))\sin\theta\} - x(t)\sin\theta \end{aligned} \quad (7)$$

With reference to Fig. 5, this implies that the cut surface is defined by the tool motion between one turn and n previous turns. Thus, the equation of motion that considers the MRE is obtained by substituting Eq. 7 into Eq. 1:

$$\begin{aligned} & \ddot{x}(t) + 2\omega_0\zeta\dot{x}(t) + \omega_0^2x(t) \\ & = \omega_0^2\gamma\sin^2\theta[\min\{x(t - (60/\Omega))\sin\theta, \\ & \quad f_0\cos\theta + x\{t - 2(60/\Omega)\}\sin\theta, \\ & \quad 2f_0\cos\theta + x\{t - 3(60/\Omega)\}\sin\theta, \\ & \quad \dots \\ & \quad (n-1)f_0\cos\theta + x\{t - n(60/\Omega)\}\sin\theta\}] - x(t)\sin\theta \end{aligned} \quad (8)$$

The overlap factor μ , which was used in the investigations by Merritt [14], is not explicitly included in the equation because the variation of chip thickness is expressed as a function of the side cutting angle and work displacement. Equation 8 can be solved numerically for the terms within the parentheses.

In conventional stability analyses, which do not consider MRE, any attempt to obtain a solution in the time domain would require the assumption of any mechanism that was not directly related to chatter behaviour. Therefore, it was impossible to introduce any physical phenomenon such as the so-called penetration effect [11]. However, when using the above mentioned equation of motion, if any mechanisms to be considered in the behaviour are

assumed into the equation based on experimental results or theoretical examination, the solution can possibly verify the effects of the occurrence of chatter. In the following, the effects of considering MRE on chatter behaviour are investigated.

By analyzing the equation of motion in the time domain, the penetration effect, which is known to increase the stable machining area at low cutting speeds, is verified by substituting into

$$F = -q\dot{x}(t)\cos^2\theta/v \quad (9)$$

Eq. 6. However, the effect has often been of concern [11],[15],[16]. Because v is expressed in terms of D and Ω as

$$v = \pi D\Omega/60 \quad (10)$$

the equation of motion that accounts for the resistive force can be written as follows:

$$\ddot{x}(t) + 2\omega_0\zeta\dot{x}(t) + \omega_0^2x(t) = \omega_0^2\gamma\{x(t - (60/\Omega) - x(t))\}\sin^2\theta - 60\omega_0^2\gamma\eta\dot{x}(t)\cos^2\theta/\pi D\Omega \quad (11)$$

where

$$\eta = q/h \quad (12)$$

At low cutting speeds, there is a wide region where cutting can be performed stably. However, the above equations cannot directly explain this stability at low cutting speeds. In the following, it will be shown that the introduction of a resistive force, as described above, resulting from the relative motion between the tool and work, the magnitude of which was obtained experimentally, makes an explanation possible. The system has a stationary solution under the critical condition, which is assumed to be

$$x = x_0 \sin \beta t \quad (13)$$

Substituting this into Eq. 6, the critical condition and the region where the system is stable can be obtained as follows:

$$h/k \leq 2\zeta(1+\zeta)\sin^2\theta \quad (14)$$

The relation between Ω and other parameters can be derived by solving for β to obtain,

$$\Omega = \frac{60\beta}{\cos^{-1}\{1 + (\omega_0^2 - \beta^2)/\omega_0^2 \sin^2\theta\} + 2i\pi} \quad (15)$$

$i = 1, 2, 3 \cdot \cdot \cdot$

A basic experiment for identifying the characteristics of the resistive force was carried out by Kondo et al. [16],[17]. For simplicity, the cutting considered was conducted using a pipe face, as shown in Fig. 13. The pipe was made of brass, had an outer diameter of 40mm, and a thickness of 3mm. A tool whose side cutting angle was 90° was operated manually and periodically moved back and forth during cutting. This arrangement ensured that the variation in chip thickness was negligible; thus, the variation in the resistive force could be observed only in the radial direction during cutting. The cutting force was measured using a dynamometer with a strain gage.

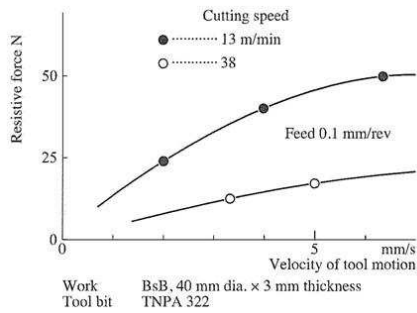

Fig. 14. Relation between velocity of tool motion and resistive force

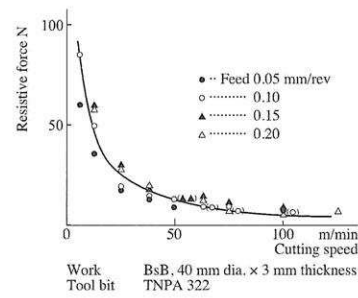

Fig. 15. Relation between cutting speed and resistive force

If the tool is moved backward along the radial direction in the conventional cutting process, a resistive force that prevents tool motion comes into play, causing the radial projection of the cutting force to decrease. The resistive force is probably caused by the friction between the work and the tool face. In the case that the tool moves forward into the work, a resistive force preventing this motion is generated because the tip of the tool penetrates into the work in conjunction with the opposing friction force. This leads to an increase in the radial projection of the cutting force.

Figure 14 shows relationship between the tool movement speed and the resistive force. Although the movement speed is not sufficiently high, the resistive force is saturated even within the indicated range; in contrast, when the tool movement speed is low, both relationships are proportional. Figure 15 shows the relationship between the cutting speed and resistive force, considering data from around the saturation point in Fig. 14. This shows that the resistive force is inversely proportional to the velocity of the manually operated sinusoidal tool motion, which presents an experimental basis for penetration effect of Eq. 9. Analyzing the stability limit chart using Eq. 9, it was shown that the range of stability widens at low cutting speeds compared with the conventional stability characteristic without considering an enlarged stability range, as shown in Fig. 16.

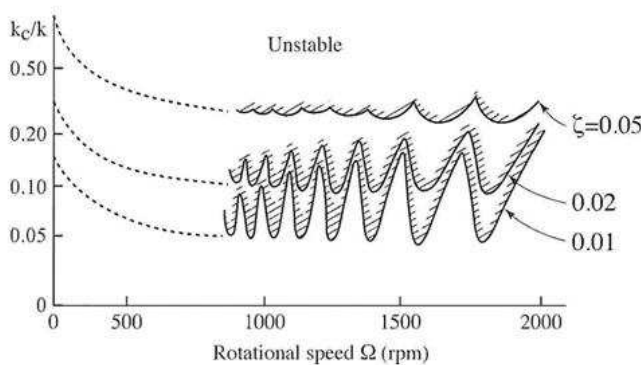

Fig. 16. Effect of resistive force on stability chart

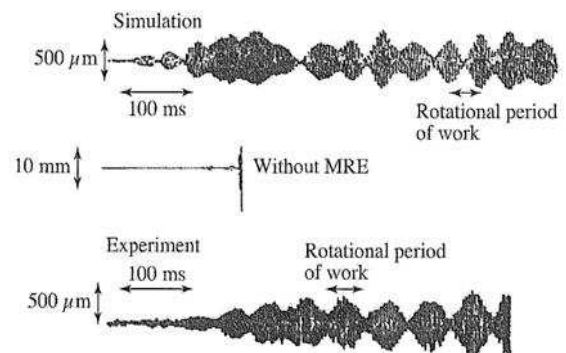

Fig. 17. Comparison of waveforms for verifying MRE

When both the resistive force and the MRE are considered, Equation 8 becomes

$$\begin{aligned} & \ddot{x}(t) + 2\omega_0\zeta\dot{x}(t) + \omega_0^2x(t) \\ & = \omega_0^2\gamma\sin^2\theta\Delta u - 60\omega_0^2\gamma\eta\dot{x}(t)\cos^2\theta / \pi D\Omega \end{aligned} \quad (16)$$

Another reason for a large absolutely stable region at low cutting speeds, which is related to low-frequency excitation, may partly be connected with the impedance characteristic shown in Fig. 4, which is the behaviour of the spindle-workpiece system relative to the cutting force. In a certain low-frequency range, the behaviour shows the characteristic of mass, which would prevent the conditions that lead to chatter. Consequently, it was clarified through cutting on an engine lathe that the stable region at low cutting speeds owing to two reasons: *the penetration effect prevents chatter generation and the mass characteristic at low cutting speeds prevents chatter*. The proposal that process damping would work to widen the stable region at low cutting speeds by providing the equivalent of Eq. 9 was put forth by Altintas et al. [29]. However, *the analysis described above does not entirely account for specific damping*.

Figure 17 shows a comparison of the waveform obtained from Eqs. 6 and 16 by numerical integration using the Runge-Kutta method with that obtained experimentally. *The solution of the equation that is described in terms of the simple regenerative effect diverges immediately after the onset of chatter; however, the solution of the equation that considers the MRE oscillates with a finite amplitude modulated by the rotational speed, and the shape of the waveform agrees quantitatively with that obtained experimentally.*

5. ANALYSIS CONSIDERING MRE WITH TWO AXES

5.1. FORMULATION OF ANALYSIS

Doi and Kato [30] pointed out that the limit cycle for chatter, obtained from Doi's analysis based on his observations of chatter behaviour after its onset [2], results in chatter vibration while sustaining a finite amplitude. Their statement may have been influenced by the academic environment at that time, in which the limit cycle was focused on and the stability limit of the system for nonlinear systems was being debated. However, in the equation of motion discussing the limit cycle, the MRE is not considered. In addition, the term indicating the phase relationship between the displacement and the cutting force was focused on by Doi in his first investigation and considered in the equation of motion with which the vibration system was analyzed by Doi and Kato [30]. However, in the analysis of Kondo et al. [16] and Kaneko et al. [31], and in the later contribution of Kasahara et al. [32], *the phase relationship appears in the simulated vibration behaviour even without this term in the equation of motion. This means that the analysis in which the term pertaining to the phase relationship was introduced misunderstands the cause and effect of the chatter*. Therefore, the scope of the mechanism and its parameters were not entirely revealed, and they could not have comprehended the entire structure of the self-excited vibration. A detailed investigation on the cutting dynamics by Kegg [15] indicated

that a phase difference is always present between the dynamic cutting force and the oscillatory uncut chip thickness, but the reason for this difference was not clarified.

Since phenomenon of self-excited vibration is deceptive, insight into what occurs during mentioned phenomenon is required for determining the nature of the chatter mechanism. The role of nature was unravelled intricately in the case of the singing flame and boiling water, as shown by Fujii [9]. Doi first misunderstood the phenomenon as forced vibration [2], and even after he noticed that it is self-excited vibration, he mistook the cause and effect in equation of motion by introducing a term pertaining to phase relationship, which he observed in his first paper [2]. This indicates the extent of difficulty involved in gaining precise insight into the mechanism of chatter from its phenomena. In the following text, it is clarified that not assuming the phase relationship term in the equation of motion leads to chatter and the phase relationship itself.

The role of the MRE by considering motion in a single direction was investigated as described above. However, as pointed out by Saljé [33], it is preferable to analyze the role of the MRE in detail by considering the behaviour of the work during chatter on a plane orthogonal to the axis of the work and spindle by adding a vertical coordinate. A model of the system and its schematic view in terms of the tool and work adopted by Kaneko et al. are shown in Fig. 18 [31].

For the system shown in Fig. 18, the equation of motion is derived using a simple SDOF system and can be written as follows:

$$\begin{aligned} m\ddot{x} + c\dot{x} + kx &= F_x \\ m\ddot{y} + c\dot{y} + ky &= F_y \end{aligned} \quad (17)$$

where x and y are taken such that the position of the center of gravity of the work when stationary can be considered zero. The damping ratio and spring constant for both directions are considered equal for simplicity. F_x and F_y are ordinarily assumed to be proportional to q as follows:

$$\begin{aligned} F_x &= K_x q \\ F_y &= K_y q \end{aligned} \quad (18)$$

and q is given below, assuming that the tool shape is that shown in Fig. 12 and that the trace of the horizontal displacement of the work for one, two, and a greater number of previous turns contribute to the uncut chip thickness. The nose radius of the tool was considered as zero for simplicity; then,

$$q = ws \quad (19)$$

where

$$\begin{aligned} w &= \frac{\Omega f \cos \theta}{60} t - x(t) \sin \theta: & 0 \leq t < 60/\Omega \\ w &= f \cos \theta + \min\{x(t - \frac{60}{\Omega} \sin \theta), f \cos \theta + x(t - 2\frac{60}{\Omega} \sin \theta), \\ &\cdot \cdot \cdot (n-1)f \cos \theta + x(t - n\frac{60}{\Omega} \sin \theta)\} - x(t) \sin \theta \\ & & 60/\Omega \leq t \end{aligned} \quad (20)$$

$$(21)$$

$$s = \left\{ \frac{d - x(t)}{\cos \theta} - \frac{w}{2} \tan \theta \right\} \quad (22)$$

Equations 20 and 21 are formulated for the interval of the first turn and that from the second turn, respectively, which are related to the MRE. When the tool is separated from the work, w is negative. However, it is set to zero in the simulation. The relationships described above are valid for $f < d$. By observing the behaviors of the displacement and cutting force during chatter, the behavior of the horizontal displacement versus the horizontal projection of the cutting force, originally reported by Doi [2], is shown in Fig. 19, in which the loop rotates clockwise. This indicates *the characteristic of chatter behavior that the cutting force decreases even if the chatter amplitude increases*.

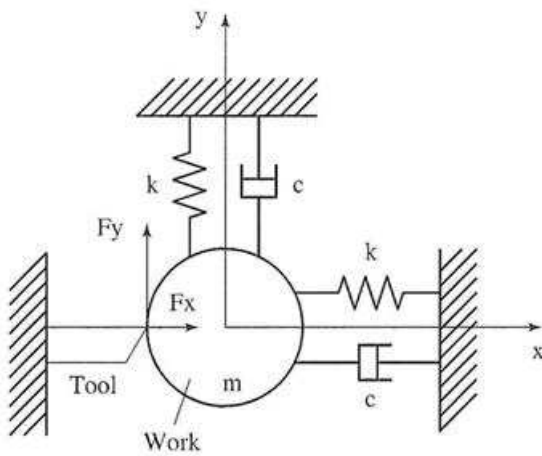

Fig. 18. Vibration model for analysis of workpiece motion along two axes

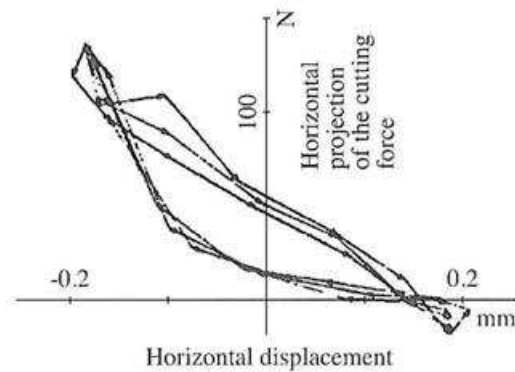

Fig. 19. Behaviour of horizontal displacement against horizontal component of cutting force

In the following, the equation in relation to x in Eqs. 7-19 is replaced with

$$F_x = K_x q - T \quad (23)$$

where

$$T = \alpha \frac{\dot{x}(t) \cos^2 \theta}{v} \quad (24)$$

$$v = \frac{\pi D \Omega}{60} - \dot{x}(t) \quad (25)$$

Figure 20 shows the behaviour of the work motion during chatter. Fig. 21 shows that the analytical results obtained by solving Eqs. 18 and 24 using the Runge-Kutta-Gill method are comparable to those shown in Fig. 20. The characteristic of a locus describing a loop can be obtained by considering the resistive force shown in Figs. 14 and 15, as described by Kondo et al. [16], *without which the locus shown in Fig. 21 is a motion along a straight line*. The fundamental properties of the resistive force are as follows: 1) *it is inversely proportional to the cutting speed*, 2) *it is proportional to the horizontal relative velocity between the tool and work*, and 3) *it is independent of the chip onto the tool tip*.

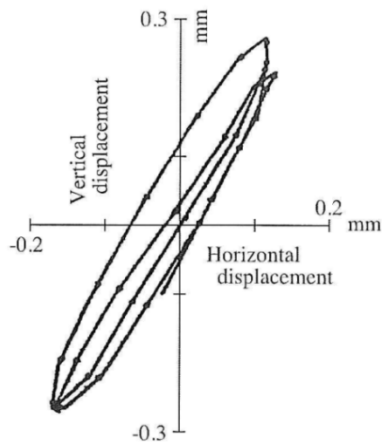

Fig. 20. Behaviour of work motion during chatter

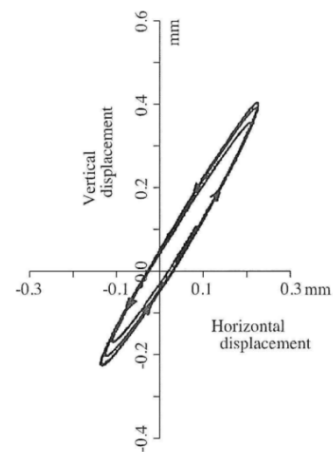

Fig. 21. Behaviour of work motion by analysis

The phase lag *projected area of the uncut chip* between displacement and cutting force was first pointed out by Doi [2], and at the beginning of their investigation, as recognition of self-excited vibration, this effect was introduced into the equation of obtained by considering the resistive force shown in Figs. 14 and 15, as described by Kondo et al. [16], *without which the locus shown in Fig. 21 is a motion along a straight line*. The fundamental properties of the resistive force are as follows: 1) *it is inversely proportional to the cutting speed*, 2) *it is proportional to the horizontal relative velocity between the tool and work*, and 3) *it is independent of the projected area of the uncut chip onto the tool tip*. The phase lag between displacement and cutting force was first pointed out by Doi [2], and at the beginning of their investigation, as recognition of self-excited vibration, this effect was introduced into the equation of motion used for analysis by Doi and Kato [30]. However, it was clarified that *when the MRE and resistive force are taken into account in the equation of motion, a solution in which the relation appears naturally in chatter behaviour can be provided by Kondo et al. [16],[17] and Kaneko et al. [31]*. This proves the importance of the term with the resistive force, i.e., the phase difference can appear without the force term pertaining to the phase relationship between the displacement and the force using the direct form of the relation in the equation of motion.

5.2. RELATION BETWEEN CHATTER MARKS AND MRE

Figure 22 shows an example of a chatter mark, in which a pattern of lobes appears. In the following text, the composition of this pattern is discussed by Kaneko et al. [31] by considering the correlation of chatter behaviour with the pattern. The slopes of the lobe patterns appeared to decrease along the feed direction and then increase. An observation of the contour forms of the two-dimensional surface of the chatter patterns using the device developed by Uchida et al. [27] reveals that hollows or ridges in the neighboring pattern are located slightly lower along the feed direction, the lobes of which move downward along the direction, that is, lobe inclination of decreases.

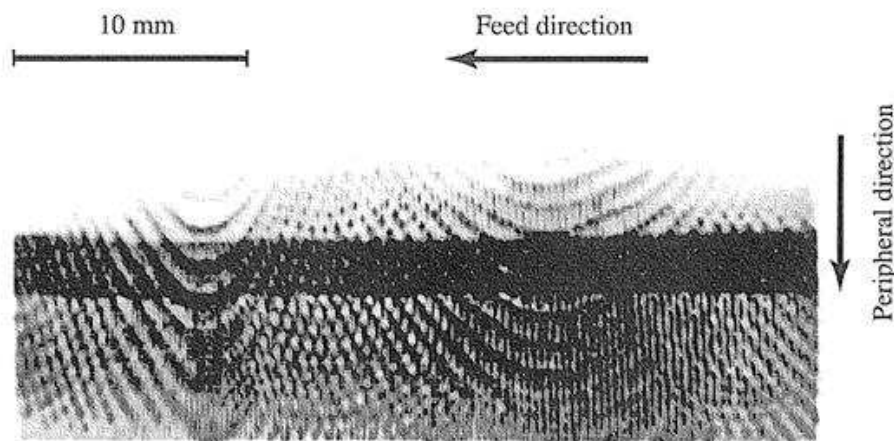

Fig. 22. Example of chatter mark showing lobe pattern

There was a misunderstanding that the specific patterns of the chatter marks are correlated with the phase relation between the workmotion and the cutting force, as observed by D[2]. However, this misunderstanding was dispelled through a precise observation of chatter marks using the device developed by Uchida et al. [27], as well as through the MRE-based analysis performed by Kaneko et al [31]. The lobes move slightly upwards along the feed direction; this tendency is symmetrically opposite, that is, the inclination of the lobe increases with the feed. The case that the hollow areas are located between one another corresponds to the bottom of the lobe at the turning point from the inclination of the decrease to that of the increase.

Because the frequency of the self-excited vibration is sufficiently high relative to the rotational speed of the workpiece, the number of waves left in one rotation of work surface is large enough. Therefore, the mutual position relationship for the respective rotations, i.e., phase relationship from one revolution to the next, varies easily for even a slight change in the chatter frequency. This indicates that even a slight frequency change owing to minute changes in the cutting conditions during cutting may easily change the lobe pattern from the decrease inclination to increase inclination. In the investigation by Kaneko et al., this is verified in detail using measured results [31].

The surface form corresponding to the chatter marks can be analytically described by the solution of the equation of motion considering MRE. Figures 23 and 24 are examples of surface forms for the following cutting conditions are assumed: $\Omega = 600$ rpm, $f = 0.05$ mm/rev, $d = 1.5$ mm, $D = 42$ mm, $R = 0.4$ mm, and $\theta = 45^\circ$; the frequency of vibration is taken as $f_s = 198$ Hz. The patterns and shapes on the surfaces shown in Figs. 23 and 24 are for $f_s = 198.27$ and 198.40 Hz, respectively. The former indicates pattern of the decrease inclination and the latter that of the increase inclination. The change in frequency is only 0.13 Hz, and the pattern of the chatter mark moves in the direction opposite to the inclination. The phase relationships for each revolution remain small: 62.3° and 57.6° , respectively. Changes in the pattern of the chatter mark, which were caused by a slight frequency change, could be demonstrated relative to the quantitative phase relation determined by simulation. This can be used for elucidating the pattern characteristics.

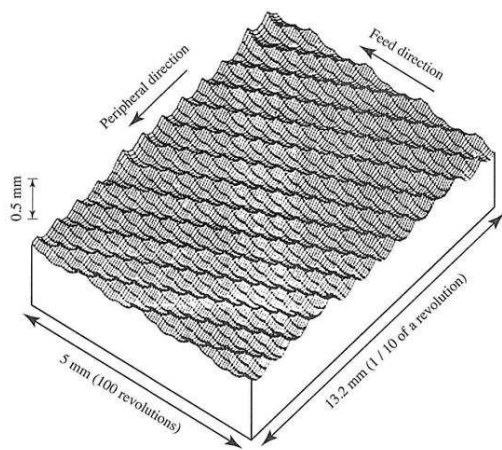

Fig. 23. Simulation of downward chatter mark for progressing feed ($f_s = 198.27\text{Hz}$)

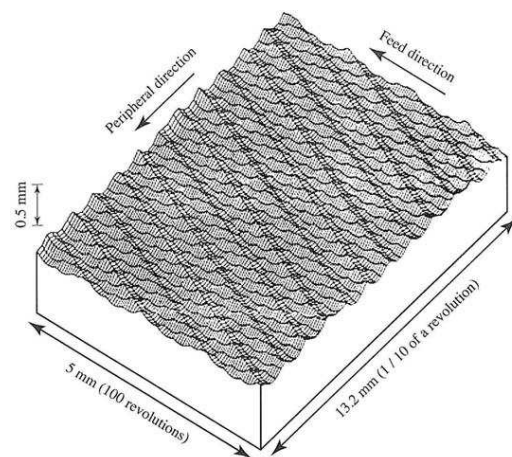

Fig. 24. Simulation of upward chatter mark for progressing feed ($f_s = 198.40\text{Hz}$)

The frequency change described above could not be obtained directly through conventional frequency analysis owing to the lack of resolution. A comparative method using a digital oscillator and a synchroscope made it possible to confirm that a very small frequency change occurred as the tool was fed. This change could be ascribed to the fact that the work was held only by a chuck and the tool moved while in contact with the work.

Because the above-described role of the MRE in the system with two axes is now confirmed, the phase difference due to the MRE is measured and the chatter mark pattern is characterized. In the following, the relationship between the frequency and the pattern is verified by assuming a sinusoidal waveform and by generating the cut surface through simulation. The obtained trace of the residual vibration on the surface is analyzed by simulating the trace obtained from chatter by assuming the following.

1. Only the horizontal projection is considered as the vibration component.
2. The waveform is replaced with a sinusoidal one.
3. The shape of the cut surface is obtained by combining the traces that are the closest to the center of the work.
4. For simplicity, the waveform in the simulation is that of a single-axis system.

The change in the chatter mark pattern, caused by the slight frequency change, could be demonstrated in relation to the quantitative phase relationship determined in the simulation. This can be used for elucidating the pattern characteristics.

6. OCCURRENCE FREQUENCY OF MRE IN OPERATION AND USE IN CHATTER SUPPRESSION

Figure 25 shows an overview of the measurement system, which was designed by Kasahara et al. [32], for scrutinizing the relationship between phase difference and chatter behaviour. Concerning the phase relationship, there is the relationship between cutting force

and work displacement, as pointed out by Doi. Chatter marks left on the workpiece occasionally appear as specific geometrical patterns, which were precisely analyzed by Kaneko et al. [31] in Chapter 5, and were found to form a different type of relationship than that indicated by Doi. These relations can be defined in terms of time phase and space phase, as shown in Figs. 26 and 27, respectively, for the suggestions of Doi and the analysis of Kaneko et al.

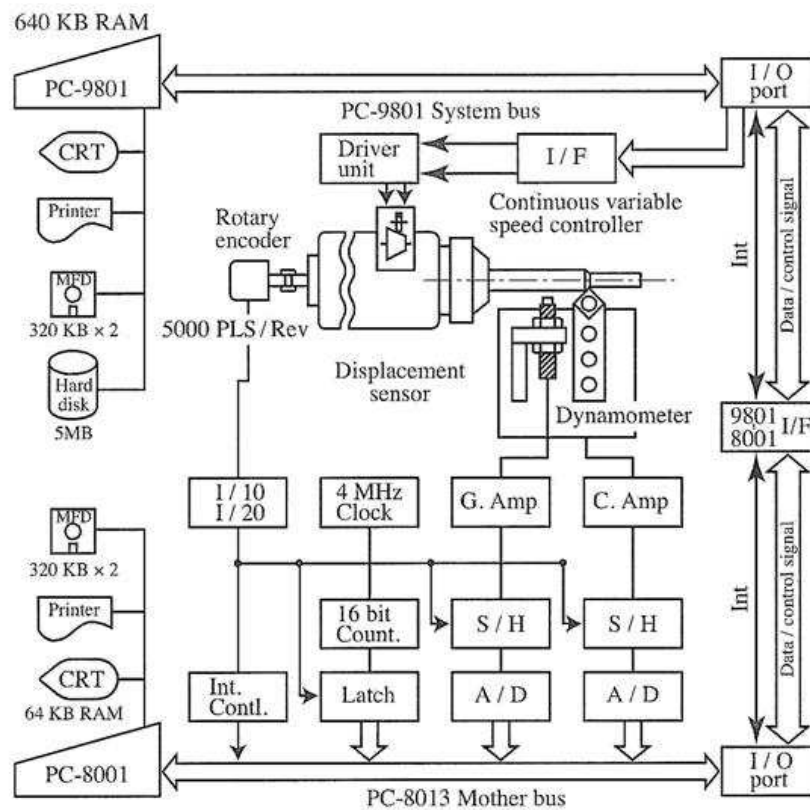

Fig. 25. Flow diagram of measurement system for *analyzing phase relationship during chatter occurrence*

The displacement and cutting force were digitized using the pulses synchronized with the rotary encoder connected to the lathe spindle. The digitized data were analysed using a PC. The other PC in the system was used data acquisition. Chatter behaviour relative to parameters shown in Fig. 28 can be recorded by the system. The aim of the measurement system was to confirm whether chatter can be suppressed by varying the rotational speed of work and the functioning of the phase relationships should the purpose be attained. However, in the conducted investigation, the purpose was not achieved. The engine lathe used in the investigation is equipped with a variable-speed motor. The rotational speed of the workpiece decreased and increased alongside the occurrence of chatter, as shown Fig. 28 (a), in which the chatter amplitude was increased and decreased, respectively. In contrast, the cutting force did not vary as chatter amplitude was varied.

This can be attributed to the fact that chip thickness does not depend on chatter amplitude and remains almost constant over the entire range of chatter amplitude variation.

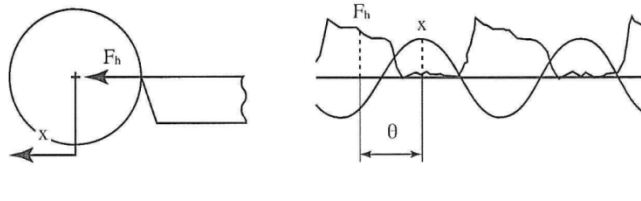

Fig. 26. Illustration of space phase

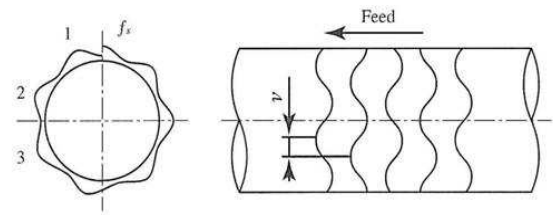

Fig. 27. Illustration of time phase

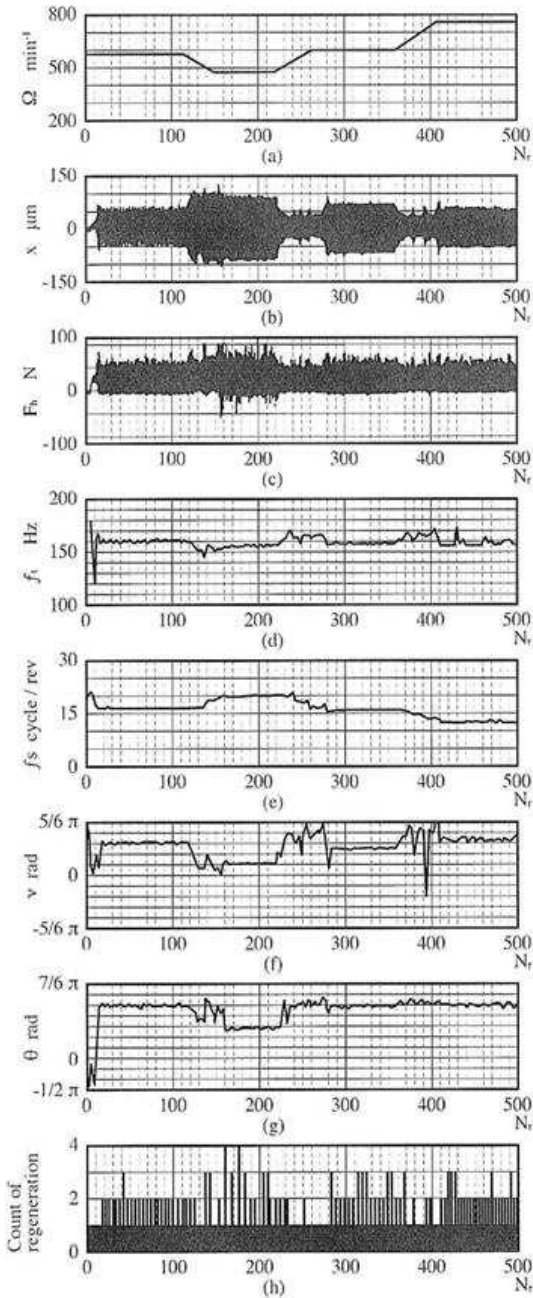

Fig. 28. Behaviour of parameters during chatter occurrence for different rotational speeds of work

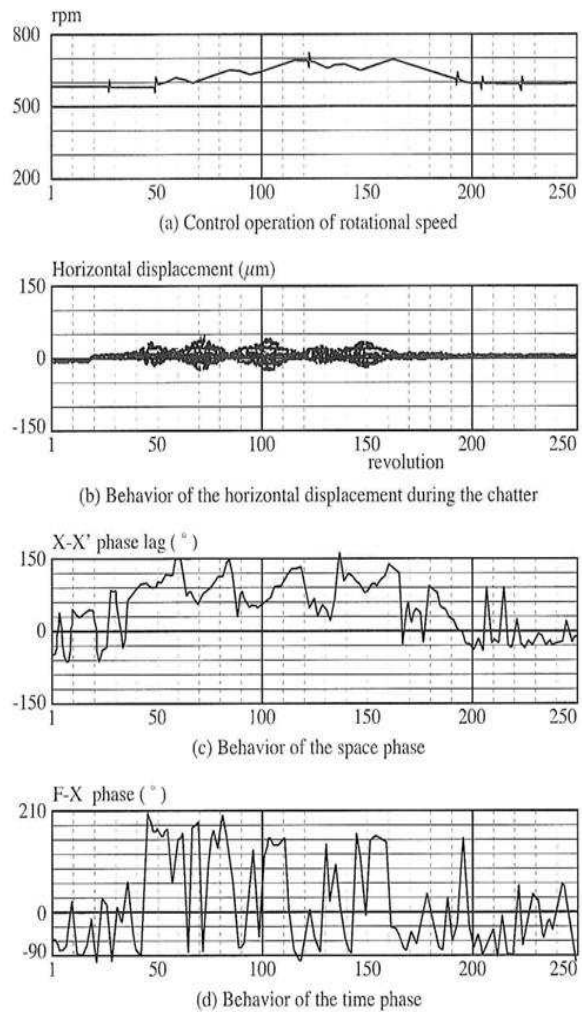

Fig. 29. Chatter suppression by controlling cutting speed referring to space phase

Meanwhile, the occurrence of MRE during cutting was varied. This might lead to the conclusion that the observation parameters were selected voluntarily depending on the shape of the tool tip, cutting condition, and vibration amplitude. However, because chatter behaviour in relation to MRE was understood, an adequate number of focus parameters were selected. MRE occurrence is proved by drawing the plan figure of the shape of a tool tip on the trace of chatter at a constant angle during continuous rotation. The analytical results obtained by O-hori et al. [34] indicate that frequency occurrence the MRE can be easily counted not just twice, as shown in the principle in Fig. 5, but several times. In Fig. 28(h), the MRE appeared up to 10 times. Stoeferle and Grab indicated that any disturbance resulting in a variation in the rotational speed of spindle-workpiece system during chatter could suppress chatter [35], and similar studies were subsequently conducted by Inamura and Sata [36], Takemura et al. [37], Sexton and Stone [38], and Smith and Tlustý [39]. However, as long as the experimental analysis was conducted using the system shown in Fig. 25, the purpose was only partly served. In the following, the characteristics of the chatter obtained by varying the rotational speed are considered in terms of control theory and chatter suppression is attempted by varying the rotational speed with the space phase as the control parameter. Figure 29 shows the control procedure. The rotational speed is alternately increased and decreased to suppress the vibration. Figures 29 (a)-(d) show the rotational speed, vibration amplitude, space phase, and time phase, respectively, as the rotational speed was varied.

Table 2. Cutting conditions for manually varied rotational speed of work

Rotational speed	400 – 800 mm ⁻¹ (variable)
Feed	0.05 mm / rev
Depth of cut	0.5 mm
Tool bit	Tip radius : 0.4 mm Angle of side cutting edge : 0.79 rad Rake angle : 0.10 rad Material : Tungsten carbide Type : SNMR-431C
Work	Material : Brass Hold condition : Chucked only at one end Diameter : ϕ 50 mm Effective length : 300 mm Natural frequency : 156 Hz Stiffness to horizontal direction at free end : 2 N / μ m

The rotational speed in Fig. 29 (a) was varied manually, but the actual motor speed is controlled by a system that detects the displacement and the space phase in a computer. The occurrence of chatter could not be completely suppressed by this control method so long as

cutting conditions that caused the chatter existed. However, if the rate of vibration for the rotational speed is varied, which was maintained constant in the system for the sake of machine tool performance, chatter could be suppressed owing to disturbance of the phase relationship. By observing the procedure described above, more effective control than that available with the present system can be achieved.

7. CONCLUSION

Investigation on chatter in cutting as self-excited vibration and an analysis on stability limit were performed. The importance of the mechanism sustained vibration after its initial occurrence was pointed out, and it was indicated that phenomenon is governed by a mechanism called MRE. The conclusions are summarized as follows.

1. The structure of self-excited vibration consists of an analysis of stability limit and the mechanism of sustained vibration with finite amplitude after onset. The behavior called MRE was first pointed out as cause of this phenomenon, and MRE was introduced into equation of motion. The reason for sustained chatter can be obtained by solving the aforementioned equation in the time domain. Under the occurrence of MRE, the cutting tool is separated from the workpiece, and chip thickness varies depending on the period of such separation. This means that the regenerative effect occurs multiple times and the excitation energy leading to self-excited chatter under the normal regenerative effect stops flowing into the system, thus resulting in sustained self-excited vibration of finite amplitude.
2. The relationship of the resistive force for tool motion corresponding to the penetration effect was confirmed via a simple, but effective experiment. It was found that the resistive force is inversely proportional to the velocity of the manually operated sinusoidal tool, which provides an experimental basis for the penetration effect. This relation was introduced as a term in the equation of motion, and the solution was clarified, leading to a widened stable range under low cutting speeds.
3. The characteristics clarified in terms 1 and 2 could be derived without assuming any specific damping constant; consequently, only the MRE was considered in the analysis.
4. The structure of self-excited vibration generally consists of the characteristics of stability limit and those of the mechanism of sustained vibration with finite amplitude. In the case of chatter, the MRE plays role of the second component, i.e., sustaining a finite amplitude. From the beginning of the investigation on chatter, the importance of the phase relationship between workpiece motion and cutting force was emphasized, and it has been long considered as a force term in the equation of motion. However, solving the equation of motion considering the MRE yields the phase relationship even without the term similar to the phase relationship in the equation of motion. This indicates that assumption of the term in the equation of motion led to a misunderstanding about cause and effect.
5. The structure of the chatter mark was measured and its composition was investigated. It was verified analytically and experimentally that the chatter mark pattern was very sensitive to frequency changes.

6. There was an indication that any investigation after the occurrence of chatter is meaningless because the workpiece surface finish would have deteriorated. However, this was denied by the very person who adopted the MRE-related theory and applied the method to milling using core concept developed on an engine lathe. Contrary to the insistence, the possibility of effective investigation was upheld by an expert in machine tool manufacturing through the comment that the decision regarding the continuation of machining under the condition of chatter generation will be made by the production management personnel on the shop floor. Given that the solution will clarify the condition that the cutting could be stable or otherwise, the proposed method could be used for optimally efficient productivity while preventing the occurrence of chatter. This means that the method contributes not only toward theoretical analysis for effectively identifying chatter behaviour under the MRE, but also toward industrial use in operating machine tools by avoiding chatter occurrence in the stability chart for manufacturing.

REFERENCES

- [1] DEN HARTOG J.P., 1985, *Mechanical vibrations*, Dover (Originally McGraw Hill, 1934).
- [2] DOI S., 1936, *Chatter of lathe tool*, J. JSME, 39-231, July, 380-381.
- [3] SEZAWA, K., 1932, *Study on Vibration*, Iwanami.
- [4] TANIGUCHI O., FUJII S., Translated ed. of 1960, *Mechanical vibration* by Den Hartog, J.P., Corona Publisher.
- [5] ARONLD R.N., 1946, *The mechanism of tool vibration in the cutting of steel*, Proc. IME, 154, 261-284.
- [6] FUJII S., 1946, *Stability and surging of centrifugal pump*, 1st Report, Trans. JSME, Nov, 49/341, 366-369.
- [7] SAITO T., 1967, *Vibration of air column with heat source*, Science of Machine, 19/1, Jan., 187-192.
- [8] HAYAMA S., 1967, *Vibration due to water boiling*, Science of Machine, 19/1, Jan., 193-196.
- [9] FUJII S., 1972, *Motive and process for investigation of self-excited vibration*, J. JSME, 75, 646, Oct., 1503-1511.
- [10] SATO H., 1964, *Stabilization by additive signal*, handbook of control engineering, Asakura Publisher, 248-251.
- [11] TOBIAS S.A., FISHWICK W., 1958, *The chatter of lathe tools under orthogonal cutting conditions*, Trans. ASME, 80, 1079-1088.
- [12] PETERS J., VANHERCK P., 1963, *Ein Kriterium fur die dynamische Stabilitaet von Werkzeugmaschinen*, Ind. Anzeiger, Jan.
- [13] TLUSTY J., 1965, *A method of analysis of machine tool stability*, Proc. 6th MTDR, 5-14.
- [14] MERRITT H. E., 1965, *Theory of self-excited machine tool chatter*, Trans. ASME, B, 87/4, Nov., 447-454.
- [15] KEGG R.L., 1965, *Cutting dynamics in machine tool chatter: contribution to machine tool chatter research-3*, Trans ASME, J. Eng. Ind., Nov, 464-470.
- [16] KONDO Y., KAWANO O., SATO H., KOMAZAKI, M., 1981, *Behaviour of self-excited chatter due to multiple regenerative effect*, Trans. JSME, C, 46-409, 1980-9, 1024-1032.
- [17] KONDO Y., KAWANO O., SATO H., 1981, *Behaviour of self-excited chatter due to multiple regenerative effect*, Trans. ASME, J. Eng. Ind., 103-3, Aug. 324-329 (received March 7, 1980, contributed WAM, Nov. 16-21, 1980, as 80-WA/Prod-24).
- [18] HONDA M., YASUI T., 1964, *Basic and technical investigation on stiffness of machine tool*, J. JSME, 67-546, July, 1046-1061.
- [19] SATO H., AKUTSU T., 1972, *A study of characteristics of dynamic identification of machine tools by means of micro tremor*, Proc. 12th MTDR, 281-288.
- [20] WATARI A., 1954, *Dynamics of machines*, Kyouritsu Publishing.
- [21] SATO H., 1965, *A study on aseismic design of machine structures*, Report IIS UT, 15/1, Nov., 102.
- [22] CRANDALL S. H., 1958, *Impedance and mobility analysis of lumped parameter systems*, Coll. on Mechanical Impedance Methods for Mechanical Vibrations, ASME, Plunkett R. ed.,
- [23] SATO H., MATSUZAKI A., 1976, *Vibration of machine tools*, Taniguchi O., ed., Handbook of Vibration Engineering, Yokendo, 1083-1114.
- [24] HAHN R.S., 1953, *Metal-cutting chatter and its elimination*, Trans. ASME, Aug., 1073-1080.

- [25] NAKAGAWA T., SUZUKI K., UEMATSU T., KOYAMA H., 1982, *Production of fine short-length metal fibres using self-excited vibration of an elastic tool*, Proc. 23rd MTDR, 323-330.
- [26] MITSUI K., SATO H., 1976, *Development of an in-process sensor for surface roughness by laser beam*, Proc. 16th MTDR, 171-178.
- [27] UCHIDA S., SATO H., O-HORI M., 1979, *Two-dimensional measurement of surface method*, CIRP Ann., 28, 419-422.
- [28] TLUSTY J., ISMAIL F., 1981, *Basic non-linearity in machining chatter*, CIRP Ann., 30/1, 299-304.
- [29] ALTINTAS Y., EYNIAN M., ONOZUKA H., 2008, *Identification of dynamic cutting force coefficients and chatter stability with process damping*, CIRP Annals - Manufacturing Technology, 57, 371-374.
- [30] DOI S., KATO S., 1956, *Chatter vibration of lathe tools*, Trans. ASME, 78/5, July, 1127-1134.
- [31] KANEKO T., SATO H., TANI Y., O-HORI M., 1984, *Self-excited chatter and its marks in turning*, Trans. ASME, J. Eng. Ind., 106/3, Aug., 222-228.
- [32] KASAHARA N., SATO H., TANI Y., 1992, *Phase characteristics of self-excited chatter in cutting*, Trans. ASME, J. Eng. Ind., 114/4, Nov., 393-399.
- [33] SALJE E., 1956, *Self-excited vibrations of systems with two-degrees-of-freedom*, Trans. ASME, 78, May 737-748.
- [34] O-HORI M., SATO H., TANI Y., SUN B., 1987, *Correlation of cutting area with cutting force during self-excited vibration*, JSME Int. J., 30-263, May, 106-111.
- [35] STOEFERLE T. GRAB H., 1972, *Vermeiden von Ritterschwingungen durch Periodische Drehzahlaenderung*, Werkstatt und Betrieb, 105, Oct., 727-730.
- [36] INAMURA T., SATA T., 1974, *Stability analysis of cutting under varying spindle speed*, CIRP Ann., 23/1, 119-120.
- [37] TAKEMURA T., KITAMURA T., HOSHI T., OKAMURA K., 1974, *Active suppression of chatter by programmed variation of spindle speed*, CIRP Ann., 23/1, 121-12.
- [38] SEXTON J.S., STONE B.J., 1978, *The stability of machining with continuously varying spindle speed*, CIRP Ann., 27-1, 321-326.
- [39] SMITH S., TLUSTY, J., 1992, *Stabilizing chatter by automatic spindle speed regulation*, CIRP Annals - Manufacturing Technology, 41/1, 433-436.

NOMENCLATURE:

MRE: multiple regenerative effect
 FRF: frequency response function
 SDOF: single-degree-of-freedom
 MDOF: multi-degree-of-freedom
 UT: University of Tokyo
 GA CIRP: General Assembly, Institution of Production Engineering Research
 ASME: American Society of Mechanical Engineers
 JSME: Japan Society of Mechanical Engineering

m : equivalent mass of vibration system
 k : equivalent stiffness of vibration system
 c : damping coefficient of vibration system
 x : horizontal displacement of work
 y : vertical displacement of work

F : radial projection of resistive force
 Y_R : relative displacement between tool and workpiece
 V_R : velocity between relative motion of tool and workpiece

K_x : coefficient for cutting area giving horizontal component of cutting force

K_y : coefficient for cutting area giving vertical component of cutting force

f, f_0 : feed of tool

f_s : space frequency; number of waves per revolution of work, frequency of chatter

f_t : frequency of chatter

T_s : period of space frequency

T : period of work rotation, force working resistively to cutting force in inverse proportion to cutting speed

$\min \{ \}$: minimum of quantity within braces

μ : overlap factor

v : cutting speed

W : cutting depth perpendicular to side cutting edge

d : cutting depth in radial direction of work

S : average cutting width for side cutting edge

F_x, F_h : horizontal component of cutting force

F_y, F_v : vertical component of cutting force

x_k : digitized quantity of x , suffix k denotes the position of rotation

D : diameter of work

q : constant of proportionality for ratio of resistive force to cutting speed

θ : side cutting angle or time phase

v : space phase

n : number of multiple regenerative effects

h : constant equivalent to cutting stiffness

u_0 : nominal depth of cut

$\Delta u(x)$: chip thickness variation perpendicular to side
cutting angle

u : cutting chip thickness

t : time

Ω : rotational speed of work

ω_0 : natural circular frequency of vibration system

ζ : damping ratio of vibration system

γ : stiffness ratio

β : circular frequency for assumed solution

η : ratio of q to h

α : coefficient giving resistive force