

Stanisław LIPSKI, Marek BETIUK*

Institute of Precision Mechanics, Warsaw, Poland

* Corresponding author: betiuk@imp.edu.pl

THE INTEGRATION OF A MATERIAL STRUCTURE WITH SENSORS AND EFFECTORS – FROM THEORY TO TECHNOLOGY

© 2019 Stanisław Lipski, Marek Betiuk

This is an open access article licensed under the Creative Commons Attribution International License (CC BY)



<https://creativecommons.org/licenses/by/4.0/>

Key words: nanotechnologies, dispersed sensors, high entropy materials, smart materials.

Abstract: One of the directions of modern development in the field of material research is the inclusion of features, enabling them to detect external stimuli and change their own properties in order to adapt to changes in the environment. Such materials evoke a new design philosophy that combines the actions of sensors, executive mechanisms, and control functions in one structure, which are capable of changing their response, depending on changes detected in the environment.

In the article, the authors confront the expectations of theoretical solutions with the practical possibilities of modern technologies for the creation of intelligent engineering materials.

Integracja struktury materiału z sensorami i efektorami – od teorii do technologii

Słowa kluczowe: nanotechnologie, sensory rozproszone, materiały o wysokiej entropii, smart-materiały.

Streszczenie: Jednym z kierunków współczesnego rozwoju w dziedzinie badań materiałowych jest włączenie cech, umożliwiając im detekcję bodźców zewnętrznych i zmianę ich własnych właściwości w celu dostosowania się do zmian w środowisku. Takie materiały wywołują nową filozofię ich projektowania, która łączy działania sensorów, mechanizmów wykonawczych i funkcji sterujących w jednej strukturze, zdolnej do zmiany swojej reakcji w zależności od zmian wykrywanych w otoczeniu.

W artykule autorzy konfrontują oczekiwania teoretycznych rozwiązań z praktycznymi możliwościami współczesnych technologii tworzenia inżynierskich materiałów inteligentnych.

Dodatkową zaletą referatu są liczne przykłady nowych osiągnięć na świecie w tej dziedzinie z odniesieniami do współczesnej literatury naukowej.

Introduction

Expansive development of physics, chemistry, and material engineering has created a base of theoretical and practical knowledge allowing the formulation of concepts of new artificial materials. The use of microprocessor structures and dedicated execution algorithms allowed this base to be transformed into various methodologies of practical design and the manufacture of unknown materials with new properties. Contemporary requirements of the aerospace, defence, automotive, and other industries for increasingly advanced and innovative components have led to the

development of new generation materials which have significantly better performance and capabilities than the existing structural and functional materials. As a result, the microprocessor systems are being developed that are embedded in structural materials, are autonomous to a significant degree, and reach the set goals while remaining in interaction with their environments. The challenge is to develop controllers integrally embedded in the material which correctly read the state of the environment and accordingly adapt their control algorithms to the state of the whole structure and its operating environment. The answer to this requirement is controllers that can adapt to their operating conditions.

The main task of such controllers is an adaptive system improvement during operation and the task is achieved by the learning capability of the controller.

1. Physical material as a controlled system

In automatics, an object which is influenced during the control is called a controlled system. The material, on the other hand, is a medium of a specific form which can be processed in order to make various products. The materials include metals and their alloys, ceramics, polymers, composites, and others [1, 2, 5]. Such materials are used to build various subassemblies, machine parts, etc. which make up certain dynamic systems. For example, it can be a key component of a space or submarine autonomous device or of an aircraft influenced by many factors, including the environment. The goal of this project is to design such a material susceptible to the control signals which will simultaneously serve as a structural component of a new product. Hence, there is a need to develop materials

which are susceptible to various values, can calculate and activate their own response and communication, generate characteristics at low power supply, while maintaining their capabilities uninterrupted in the whole material volume.

The control signals for such materials can be values from various departments of physics and chemistry. The control, on the other hand, involves an action on a given component in order to achieve a specific goal. Usually, the control is related to a piece of certain information which is included in the signal. The result of control is a change of object state (properties), in this case, of a material of which a component is made. Such an operation most often involves a change of energy or the transformation of matter. This means that the material changes its properties, i.e. the controlled system directs the changes of its state under the influence of information. The materials which can behave like that are called functional materials. This group includes materials which have particular native properties and their own functions, for example, ferroelectricity, piezoelectricity, magnetism, energy storage functions, and others.

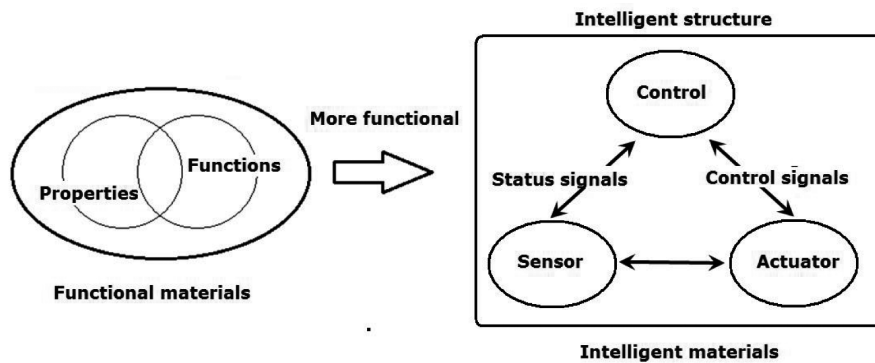

Fig. 1. Functional materials and smart materials [10]

If programmed behaviours are implemented in such materials, they are popularly called smart materials, adaptive materials, or responsive materials (Fig. 1). The terms “smart structure” and “smart materials” are often used and abused, as the materials are still far from the defined intelligence of complex systems [9].

The materials designed on purpose have one or more properties which can be changed significantly in a controlled way by external stimuli. Such stimuli can include stresses, temperature, humidity, pH, electric, electromagnetic and magnetic fields, light, radiation, or chemical compounds in various forms. Smart materials are a basis of many applications, including sensors, controllers, and actuators, such as artificial muscles. A model of such an object is presented in Fig. 2. Such a model can be described with object change variables, e.g., unit temperature, pressure, density, internal energy, and others. The boundary differentiates separate states.

Only work or heat can cross the boundary. Hence, the variables that are capable of crossing the boundary can play the role of control variables that affect the dynamic behaviour of the whole system.

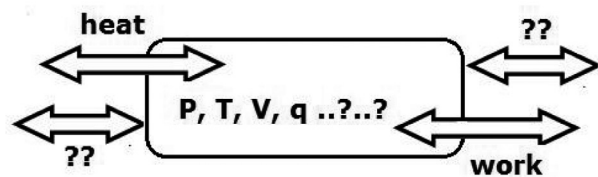

Fig. 2. Model of a material object system; based on [11]

Taking into account the fact that internal-structural processes take place in many materials, one has to account for interrelated variables which are typical for multidimensional structures. A simplified diagram

of such system with feedback is shown in Fig. 3. The feedback loop can close outside or inside the material structure, and it can compensate or amplify the environment action on material properties [3].

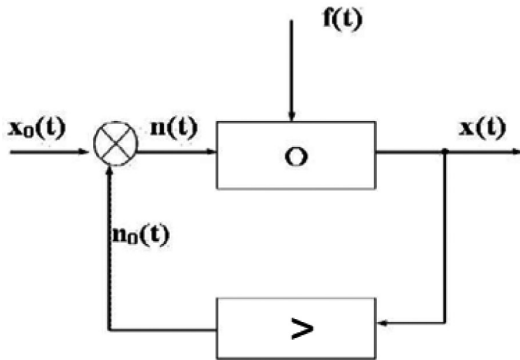

Fig. 3. Identified variables including information on adaptive material behaviour, where $x_0(t)$ – a set of variables characterizing the environment impact, O – an object with own set of state variables, $x(t)$ – a set of variables characterizing the expected object behaviour, $n(t)$ – a set of variables forcing the object behaviour with feedback component $n_0(t)$, $f(t)$ – a set of interfering variables directly affecting the object

In control systems, feedback can be defined as informative communication via which the control

function receives information of the consequences of the object control, i.e. information on the new object state that has been achieved as a result of control actions. Thanks to the feedback, the complex systems can extend beyond the range specified by the designers. New smart materials with the feedback feature create a new quality in the system with the following characteristics: the ability to gather experience, and the ability to predict their future behaviour depending on the past behaviour. Smart materials should learn by themselves, interacting with the environment.

If the material structure is controllable and can receive information from the environment and change its properties in a reversible manner depending on the changes in the environment, some researchers include such material in the group of “smart” materials [12]. The concept of “smart” or “intelligent” structures, materials, systems, and structures has been known for many years. However, in the last decade, significant progress has been made in the development of structures that constantly and actively monitor and optimize themselves and their characteristics. The dominating trend is to imitate biological organisms, thanks to their adaptation capabilities.

A general model of a smart material is presented in Fig. 4. The specific challenges related to the implementation of this concept can be divided into four areas. The first three were defined by B. Warneke, K. Pister and B. Liebowitz as detection, quantification,

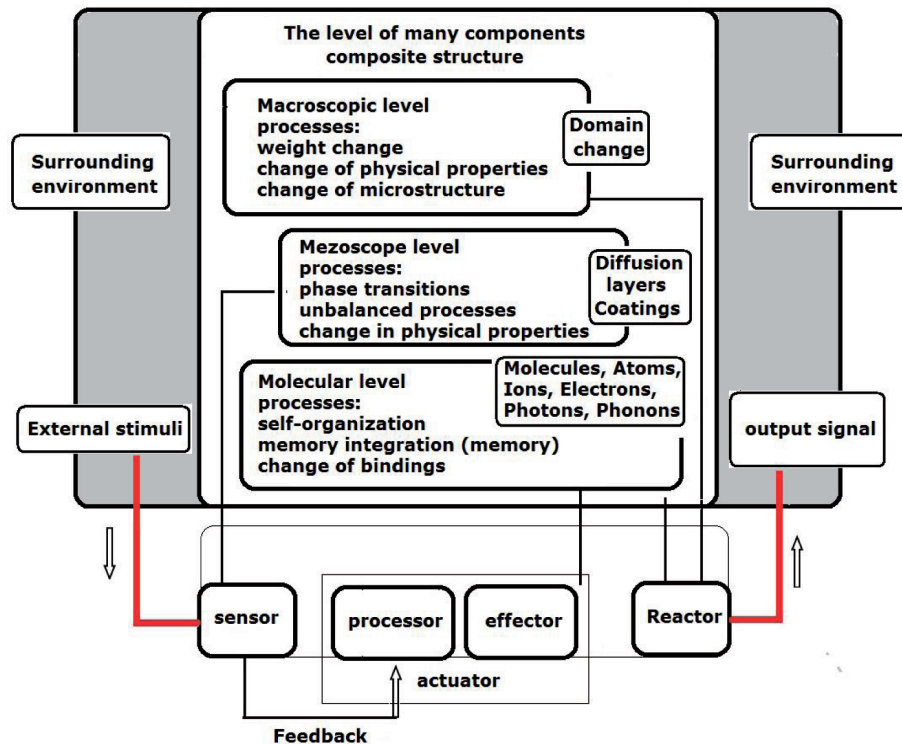

Fig. 4. General diagram of a complex smart material system

and communication systems [13]. The fourth problem, which becomes increasingly difficult at miniaturization, is the modules mobility. It involves their appropriate placement in the structures of such materials. An additional difficulty is the invisibility of these “modules” in the structure.

A new structure is formed, which is understood as a comprehensively defined and relatively stable order of internal relations between the material subsystems. Unlike the term “structure,” the term “organization level” also includes a concept of the change of the existing structures and their order during the key development operations on a material since its creation [7]. In current technological conditions, the structure change can be random and not always appropriately directed, similarly to the material organization change. However, the literature often includes numerous description of various material systems which have reached an adequate organization level and have a specific structure, which acquire the ability to use information in order to keep (or increase) the organization level by managing and promoting stability (or decreasing) their entropy) [14].

The development of a concept of smart material design and behaviour in the target operating environment requires an interdisciplinary approach. This includes a number of technologies in the area of material engineering, control techniques, information processing, sensorics, activation, and attenuation, and systems integration in a wide range of industrial applications. The analysis of dynamics of such systems becomes a complex, multilevel, and multidimensional issue. There are phenomena perceived both on the surface and in the structure of the material. Then, the structure can be analysed on macro-, meso-, and molecular levels. In addition, expertise in such fields as thermodynamics, vibration theory, structure dynamics, material science,

control theory, computer modelling, etc. is very useful. Therefore, the works on the “intelligence” of material structures, that is the structures that can transmit information about their environment to their “intelligent” structure and/or a monitoring device, are revolutionizing many fields of science [4].

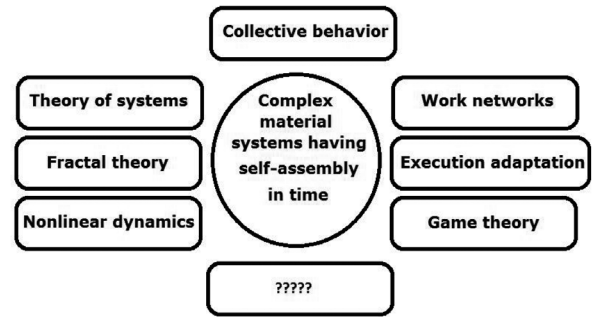

Fig. 5. Analytical tools of complex systems

The intelligence can be present in the next generation responsive materials and can include a few categories which are also observed in the studies of biological and sociological systems.

1.1. Material properties used in the automatic control technologies

The design concept and construction of a final smart material requires a strong feedback in material structures that activates its required adaptive features. These works use the existing physical properties of solids and liquids that allow implementing the feedback.

Table I includes the represented classes of materials whose properties have impact on the design of automatic control systems structurally located in the material.

Table 1. Classes of sensor and actuator materials [15]

Application	Material class	Stimulus	Response
Sensors	Pyroelectric	Temperature change	Electrical polarization
	Piezoelectric	Mechanical deformation	Electrical polarization
	Electrostrictive	Mechanical deformation	Electrical polarization
	Magnetostrictive	Mechanical deformation	Change of magnetic field
	Electroactive polymers	Mechanical deformation	Electrical polarization
	Electroluminescent	Electric field	Light emission
	Photoluminescent	Incident light	Light emission
	Electrochromic	Electric field	Colour change
Actuators	Piezoelectric	Electrical voltage	Mechanical deformation
	Electrostrictive	Electrical voltage	Mechanical deformation
	Photostrictive	Incident light	Change of physical properties, mechanical deformation
	Magnetostrictive	Magnetic field	Mechanical deformation
	Shape-memory alloys	Temperature change	Mechanical deformation
	Electroactive polymers	Electric field	Mechanical deformation
	Electrorheological fluids	Electric field	Viscosity change
	Magnetorheological fluids	Magnetic field	Viscosity change

2. Description of material state as a controlled system

State is a term describing a set of stable values of variable parameters describing an object. The characteristic feature of the state is that the description of variable object properties is known. The state is stable until the object activation, and if an action is performed on the object, its stage can change. The successive change of object state is called a *process*. State variables are variables whose values evolve over time depending on the values they have at a given point in time, and also depend on external values of input variables. The values of output variables depend on the values of state variables. State equations are a representation of a mathematical model of a dynamic system, and especially of the automatic regulation system. This is a good method to know the system state. The situational awareness and the knowledge of a researcher will further progress when the relationships between the state variable and other important variables are known. Therefore, in the system description, i.e. in its mathematical model, the key role is played by the relationship ruling the behaviour of the state variable, which is the state equation. Such a description is sometimes called a description in the states space or state variable model.

Often, not all state variables are available and directly measurable; moreover, it is known that the state vector is not at the same time as the system response vector. The full description also requires an equation that links the input variable (action) with the output variable (response). In physical systems, such variables include physical values such as voltage, current, velocity, position, pressure, temperature, etc. The state variables

describe the future system's response at a given present state, stimulating signals and equations describing the system dynamics [6]. Hence, the defining of variables and the correct state of the material as a controlled system is an effective tool for the development of new adaptive materials and their new applications.

3. Nanostructures integration technologies accounting for automated material behaviour

The laws of information flow and the laws of physics apply to complex systems. They include a separation (measurement), storage, processing, and transmission of information to other systems. This means that complex systems have structures and programs which allow modelling of external (and internal) influences and interactions with models. The production of 10 nm nanostructures is a very complex technological task, with a practical and basic significance, because such structures are a bridge between two worlds of mechanics of classical mechanics and quantum mechanics [8]. The material science experts have developed many techniques for the production of nanostructures necessary to manufacture functional materials. The most promising potential of a precise action on the nature of phenomena and the creation of new materials of previously unknown properties are found in the CVD (*Chemical Vapor Deposition*) and the PVD (*Physical Vapor Deposition*), which involve, respectively, the chemical or physical deposition of thin layers from the gaseous phase. The classification of thin layer deposition methods is presented in Fig. 6.

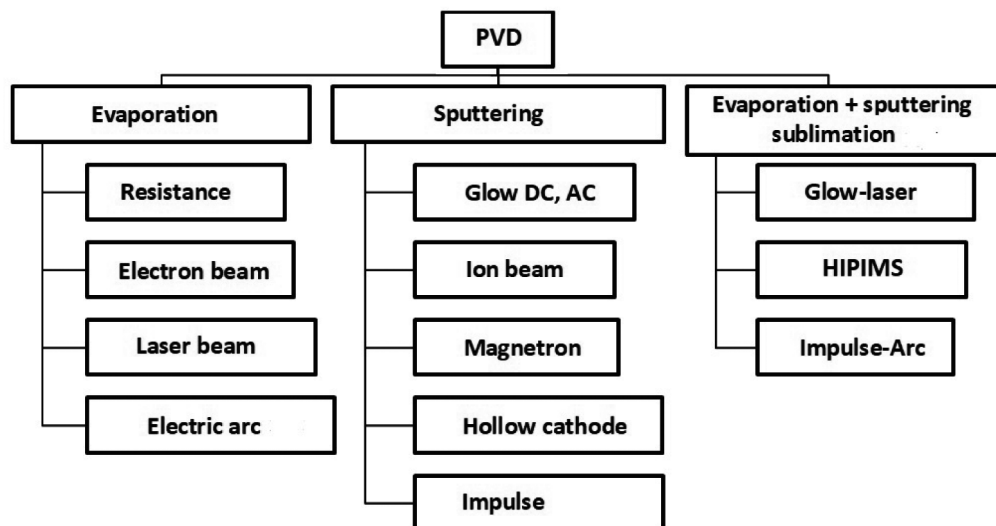

Fig. 6. Basic classification of nanolayer deposition technologies, PVD

The plasma synthesis of inorganic and organic nanomaterials in the form of thin layers, nanotextured surfaces, nanoparticles, and others has progressed significantly over the last decades. The unique plasma advantages in this field include the following:

- The specific chemical properties of unbalanced weight plasma where the precursors produced in the plasma are highly reactive radicals and ions; and,
- Increased energy transfer to the nanomaterial surfaces, which can be achieved by reactions with plasma ions, electrons, and other emitted molecules and particles.

Contemporary plasma synthesis is a supplement to other production technologies of functional nanomaterials, both in solutions, reagent vapours, and in aerosol. It is worth noting that, for some materials, it is the preferred or the only feasible synthesis method.

Inorganic nanomaterials are particularly interesting due to their electron, excitation, and plasmonic properties. It is expected that they will find application in various areas of technology, inter alia in spintronic devices and energy conversion such as photovoltaics, thermoelectrics, and catalysis, as well as biotechnology and medicine.

Plasma synthesis of zero-dimensional (0D) nanomaterials, quantum dots, or nanocrystals has found a significant application due to the plasma capability of synthesizing materials that are hard to synthesise using other approaches. Among the one-dimensional (1D) nanomaterials, the main emphasis is put on carbon nanostructures, including one- and multiwall carbon nanotubes and carbon nanofibres [4]. There are many techniques for making nanolayer coatings, but it is the PVD technique that is most frequently used in industry. This technique allows a precise control of the production of defined structural and material properties

in the nano-scotopic range. According to this method, first the material pair or mixture is created, and then it is deposited on a suitable substrate. This allows designing a material, and hence the functionality of atomic layers of a new material. The classification of smart materials is presented in Fig. 7.

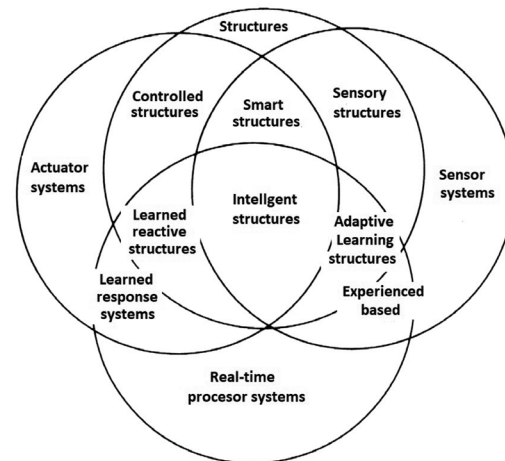

Fig. 7. Classification of smart materials based on [16]

The sectors using the most recent and advanced materials and technologies include the manufacture of aircrafts, missiles, and space facilities, and also architectural elements. The main development source is a new class of materials that has appeared in the last dozen years. The class includes representatives of all basic material types: metals, ceramics, polymers, composites, and also liquids. The development of smart materials has taken place as a result of acquiring new knowledge. [1]

An example of the structure than can be a component of a complex smart material is shown in Fig. 8.

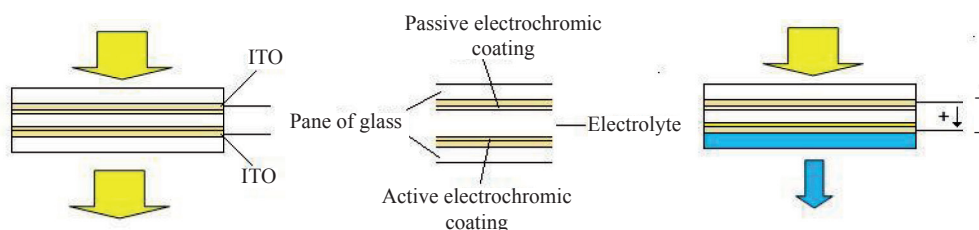

Fig. 8. Structure of a windowpane changing its optical properties as a result of electrochromic phenomena

The fully smart material system should include feedback systems which, at the present stage, are a separate programmable material structure. The materials of the future should contain the mutually internally integrated structures.

The Institute of Precision Mechanics also undertakes scientific research in this area, mainly on the development of hybrid technologies combining the layer production process and coat deposition with the use of

low-pressure plasma, galvanic processes, painting, and varnishing techniques. In the area of plasma technologies, the works are being carried out to build new sources of plasma as the physical and chemical environment of the synthesis of smart material coating structures. An example of a cylindrical magnetron plasma source for deposition of metallic and ceramic coatings is presented in Fig. 9.

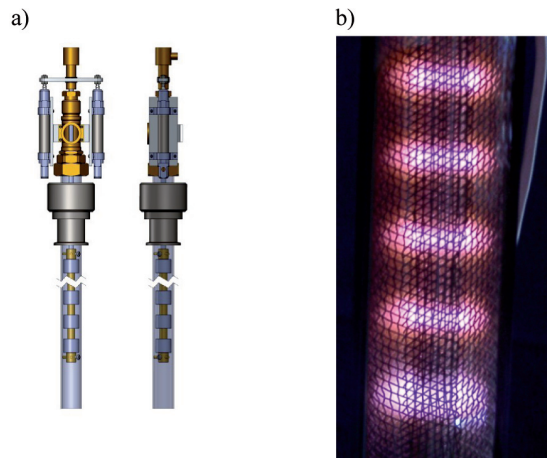

Fig. 9. Cylindrical magnetron; a) magnetron design, b) plasma toruses generated on the magnetron surface

Conclusion

As in any research area, investments in the development of adaptive materials are burdened with a significant risk and uncertainty. Taking into account that many material innovations are based on discovering fundamental new structures, and interactions and properties at the laboratory scale, there is always a significant risk that such discoveries may not yield new products that can be manufactured at acceptable costs or meet other productivity requirements.

This risk may be reduced by developing new integrated computing tools and models that can help forecast the materials and market capacity.

The material innovation processes described in this technology evaluation require a continuous support for the capital equipment for experiments, measurements, and tests, and also for pilot facilities for production, because such costs can be a significant challenge for many companies and research institutes. In addition, as noted above, taking into account that material development often requires more than ten years of work, the current research may be hard to maintain for companies and research organizations, particularly the smaller ones. The most important future material developments will include an integration of “new” and “old” materials with a growing precision and refinement, even on the nanoscale, and the examples include the “smart” materials, functional coatings, solar energy powered materials, energy storage facilities, and others. As a result, a large portion of the future value for the economy will be based on the ability to operate competitively in the areas of design, material engineering, and production.

References

1. Baldwin R.: *Developing the Future Aviation System*. Routledge, 2017.
2. Beaumont P., Soutis C., Hodzic A.: *Structural Integrity and Durability of Advanced Composites: Innovative Modelling Methods and Intelligent Design*. Woodhead Publishing, 2015.
3. Brown N.: *The Limits of Fabrication: Materials Science, Materialist Poetics*. Oxford University Press, 2017.
4. Elhajjar R., La Saponara V., Muliana A.: *Smart Composites: Mechanics and Design*. CRC Press, 2013.
5. Lipski S., Łukawski R.: *Grafen i okolice. Otrzymywanie, badania, zastosowania*. Warszawa: Inspektorat Implementacji Innowacyjnych Technologii Obronnych, 2016.
6. Mustapha F.: *Innovation in Smart Materials and Structural Health Monitoring for Composite Applications*. Materials Research Forum LLC, 2017.
7. Reece P.L.: *Smart Materials and Structures: New Research*. Nova Publishers, 2007.
8. Smith R.C.: *Smart Material Systems*. SIAM Frontiers in Applied Mathematics Series, 2005.
9. Sun B.: *Smart materials and structures*. Cape Peninsula University of Technology, 2015.
10. Lipski S., Łukawski R.: *Innowacyjne technologie dla współczesnego lotnictwa cywilnego i wojskowego (Innovative technologies for contemporary civil and military aviation)*. Scientific conference “Polish aviation and future challenges”, Akademia Sztuki Wojennej (War Studies University), 2018.
11. Addington D.M., Schodek D.L.: *Smart materials and new technologies*. Harvard University, 2015.
12. *Encyclopedia of Smart Materials*. Schwartz M. (ed.). New York: John Wiley and Sons, Inc., 2002.
13. Warneke B., Last M., Liebowitz B., Pister K.S.J.: Smart Dust: Communicating with a cubic-millimetre computer. *Computer*, 2001, 34, pp. 44–51.
14. Grant P.: *Chemistry input into the manufacturing of novel materials and future trends in manufacturing*. UK Government’s Foresight Future of Manufacturing Project, 2013.
15. Ghareeb N., Farhat M.: Smart Materials and Structures: State of the Art and Applications. *Nano Res Appl.*, 2018, 4(2), 5.
16. Kelly A. (ed.): *Concise encyclopaedia of composite materials*. England: Elsevier, 1994.

This article appeared in its printed version in Journal of Machine Construction and Maintenance. The electronic version is published in DEStech Publications, Inc., Lancaster, PA, 2019, Proceedings of FUTURE ENGINEERING CONFERENCE.