

YUQI CUI¹, XIAOYONG DENG¹, QIULING MA¹, HUIXUAN ZHANG¹, XIUWEN CHENG^{1, 2, 3, 4},
XIAOLI LI¹, MINGZHENG XIE¹, QINGFENG CHENG⁵, BO LI³

KINETICS OF PHOTOELECTROCATALYTIC DEGRADATION OF DICLOFENAC USING N, S CO-DOPED TiO₂ NANO-CRYSTALLITE DECORATED TiO₂ NANOTUBE ARRAYS PHOTOELECTRODE

As a non-steroidal anti-inflammatory drug, diclofenac, was commonly used as analgesic, antiarthritic and antirheumatic, and has frequently been detected in municipal wastewater treatment plants (MWTPs) effluents and demonstrated to be potentially environmental risk on human beings. In the present study, N, S co-doped TiO₂ nano-crystallites decorated TiO₂ nano-tube arrays (N, S-TiO₂ NCs/TiO₂ NTAs) photoelectrode was used to degrade diclofenac containing wastewater. In addition, the effects of some critical parameters including initial pH, external positive potential, sodium sulfate concentration and initial diclofenac concentration on the photoelectrocatalytic (PEC) degradation of diclofenac containing wastewater and dynamic characteristics were investigated systematically. Results showed that N, S-TiO₂ NCs/TiO₂ NTAs photoelectrode exhibited high PEC efficiency for the degradation of diclofenac, in which the PEC processes fitted well with the Langmuir–Hinshelwood (L–H) model. Furthermore, external additional anions such as Cl⁻, ClO⁻ and NO₃⁻ played an important role in inhibiting the degradation of diclofenac. Also, the N, S-TiO₂ NCs/TiO₂ NTAs photoelectrode possessed good stability for consecutive applications for degradation of diclofenac, which could potentially be utilized in wastewater treatment.

¹Key Laboratory of Western China's Environmental Systems (Ministry of Education) and Key Laboratory for Environmental Pollution Prediction and Control, Gansu Province, College of Earth and Environmental Sciences, Lanzhou University, Lanzhou 730 000, P.R. China, corresponding author X. Cheng, e-mail address: chengxw@lzu.edu.cn

²Jiangsu Engineering Technology Research Center of Environmental Cleaning Materials (CEM), Collaborative Innovation Center of Atmospheric Environment and Equipment Technology, School of Environmental Sciences and Engineering, Nanjing University of Information Science and Technology, Nanjing 210044, P.R. China.

³Key Laboratory of Comprehensive and Highly Efficient Utilization of Salt Lake Resources, Qinghai Institute of Salt Lake, Chinese Academy of Sciences, Xinning Road 18, Chengxi District, Xining 810 008, P.R. China.

⁴State Key Laboratory of High Performance Ceramics and Superfine Microstructure, Shanghai Institute of Ceramics, Chinese Academy of Sciences, Dingxi Road, Changning District, Shanghai 200050, P.R. China.

⁵College of Resources and Environment, Chengdu University of Information Technology, Chengdu 610225, P.R. China.

1. INTRODUCTION

Diclofenac is a typical non-steroidal anti-inflammatory drug, commonly used as an analgesic, antiarthritic and antirheumatic [1]. Recently, it has frequently been detected in effluents from municipal wastewater treatment plants (MWTPs) [2], which was harmful to human beings and animals. Also, some authors reported that diclofenac could induce adverse effects on aquatic life [3]. Low concentration of diclofenac could reduce the function of kidney and transform of gill of rainbow trout [4]. Besides, diclofenac also could affect the biochemical properties of fish, and damage the tissue [5]. More seriously, the toxic effect of diclofenac could be greatly increased with the existence of other pharmaceuticals [6]. Therefore, it is urgent to degrade diclofenac containing wastewater.

Advanced oxidation processes (AOPs) have been employed to treat various refractory organic pollutants recently [7]. Among them, sunlight photocatalysis deserved major attention due to the “in situ” generation of highly active species under solar illumination in the presence of catalysts [8]. Although pulverous TiO_2 nano-catalyst has been widely utilized in slurry system with excellent photocatalytic (PC) performance, it was difficult to separate and reuse the catalyst from the suspending system yet. Furthermore, bare TiO_2 can only be excited by UV light, which accounts for only 2–4% of the solar spectrum due to its wide band gap of ca. 3.2 eV (for anatase) [9]. Thus, in order to overcome the deficiencies, one-dimensional TiO_2 nano-tube arrays (TiO_2 NTAs) by anodization of Ti foils in fluorinated electrolytes have been proven as a versatile candidate, and logically facilitated good opportunity to separate and transfer the charge carriers due to its intense light-harvest scattering property and slow recombination of photogenerated charge carriers [10]. In our previous studies, highly ordered TiO_2 NTAs photoelectrode was fabricated through anodization [11, 12]. Subsequently, the as-fabricated TiO_2 NTAs were decorated with TiO_2 nano-particles (TiO_2 NPs), N, S decorated TiO_2 nano-crystallites (N, S- TiO_2 NCs), reduced graphene oxide (RGO) and Pd nano-particles (Pd NPs) [13–16], in which N, S co-doped TiO_2 nano-crystallites decorated TiO_2 nano-tube arrays (N, S- TiO_2 NCs/ TiO_2 NTAs) photoelectrode exhibited the strongest visible absorbance and highest PC performance. Besides, external potential could further promote the transport and separation of photogenerated electrons from photoanode to cathode through internal circuit, thereby resulting in an improved charge carriers separation and photoelectrocatalytic (PEC) efficiency [17].

Currently, many researchers mainly focused on the fabrication and PC activity of nanomaterials [18], while the effect of critical parameters on the PC performance and dynamic characteristic for degradation of environmental drug (diclofenac in our case) was rarely reported. Thus, in this study, the effects of some critical parameters on PEC efficiencies for degradation of diclofenac and dynamic characteristics were performed. Meanwhile, the effect of external anions on the PEC degradation of diclofenac was also

studied. Besides, the stability of N, S-TiO₂ NCs/TiO₂ NTAs photoelectrode for the degradation of diclofenac solution was measured. As a result, PEC degradation of diclofenac over N, S-TiO₂ NCs/TiO₂ NTAs photoelectrode fitted well with the Langmuir–Hinshelwood (L–H) model.

2. EXPERIMENTAL

Materials and reagents. N, S-TiO₂ NCs/TiO₂ NTAs photoelectrode (with an effective area of 1×4 cm²) was fabricated according to our previous study [14]. Diclofenac (cf. the inset of Fig. 1) was a standard sample and kindly employed from Japan Chemical Co., Ltd., and other chemicals were analytical grade and purchased from Sinopharm Chemical Reagent Co., Ltd. Methanol and acetic acid were of HPLC grade. All reagents were used as received without any further purification. Ultrapure water (18.2 MΩ·cm) was used throughout the study.

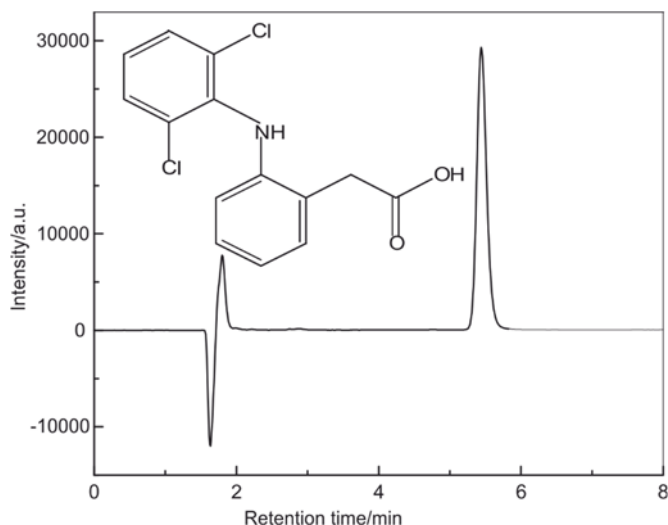

Fig. 1. High performance liquid chromatogram spectrum of diclofenac solution (5mg·dm⁻³)

PEC experiment. PEC reaction was carried out in a home-made cylindrical quartz reactor (Fig. 2), equipped with a special glass atmolyzer at the bottom of the reactor to uniformly disperse air (0.5 dm³·min⁻¹) into the solution. In each run, N, S-TiO₂ NCs/TiO₂ NTAs photoanode was vertically immersed into 80 cm³ of sodium sulfate solution, the concentration ranging from 0 to 0.1 mol·dm⁻³, and diclofenac (5–50 mg·dm⁻³), while Pt cathode was paralleled in the PEC system. pH was adjusted from 3 to 11 with 0.05 mol·dm⁻³ H₂SO₄ and NaOH solutions. Prior to irradiation, diclofenac solution was kept in the dark for 2 h to establish the equilibrium of adsorption/desorption. Afterwards, a 35 W Xenon

lamp with emitting spectrum similar to the sunlight was switched on. Besides, the desired external potential ranging from 0 to 0.4 V was applied and controlled by a two-channel output DC power supply. At given time intervals, the collected samples were filtrated and immediately measured. The influence of external anions such as Cl^- , NO_3^- and ClO^- ($0.05 \text{ mol}\cdot\text{dm}^{-3}$) on the PEC degradation of diclofenac was also investigated under similar conditions.

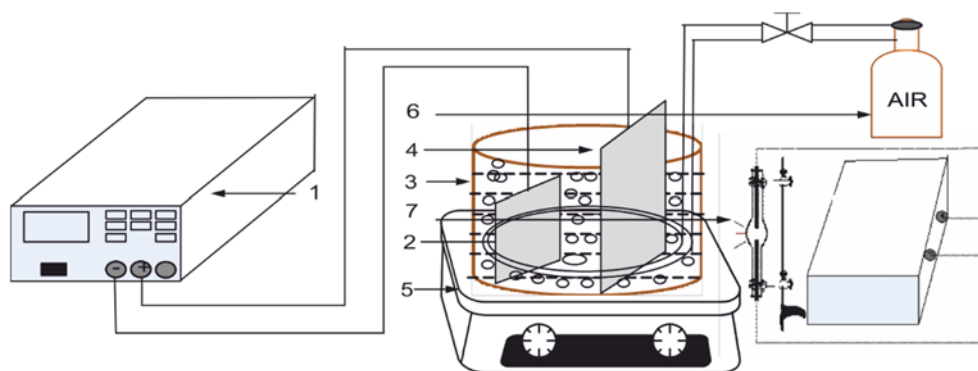

Fig. 2. Schematic diagram for PEC reaction: 1 – DC power supply, 2 – Pt cathode, 3 – quartz reactor, 4 – TiO_2 NTas photoanode, 5 – magnetic stirrer, 6 – air aerator, 7 – xenon lamp

Methods of analysis. The as-centrifuged transparent solution sample was analyzed using a Shimadzu LC 10A high performance liquid chromatograph (HPLC) equipped with a Kromasil KR100-5 C18 column ($150 \text{ mm} \times 20 \text{ mm} \times 4.6 \text{ mm i.d.}$). The mobile phase was a mixture of 75% methanol and 25% MilliQ-water (containing 1% of acetic acid) with a flow rate of $1 \text{ cm}^3 \cdot \text{min}^{-1}$. The detection wavelength was set at 276 nm, and the injection volume – 20 μL . The retention time was 5.3 min. The PEC degradation efficiency (η) was calculated by the following equation:

$$\eta = \frac{C_0 - C_t}{C_0} \times 100\% \quad (1)$$

where C_0 and C_t are the concentrations of diclofenac at zero and t moment, respectively.

Also, the PEC degradation kinetics of diclofenac under various conditions has been studied. The relationship between reaction rate and time during PC process was often investigated by using Langmuir-Hinshelwood (L–H) model [19]:

$$\ln \frac{C}{C_0} = -kt \quad (2)$$

where k and t are the apparent rate constant and reaction time, respectively.

3. RESULTS AND DISCUSSION

3.1. EFFECT OF pH ON PEC DEGRADATION OF DICLOFENAC

pH plays an important role in removal of contaminants, because it can influence the charge between solution and material interface [20]. PEC degradation efficiency of diclofenac increased at first and then decreased upon increasing pH (Fig. 3).

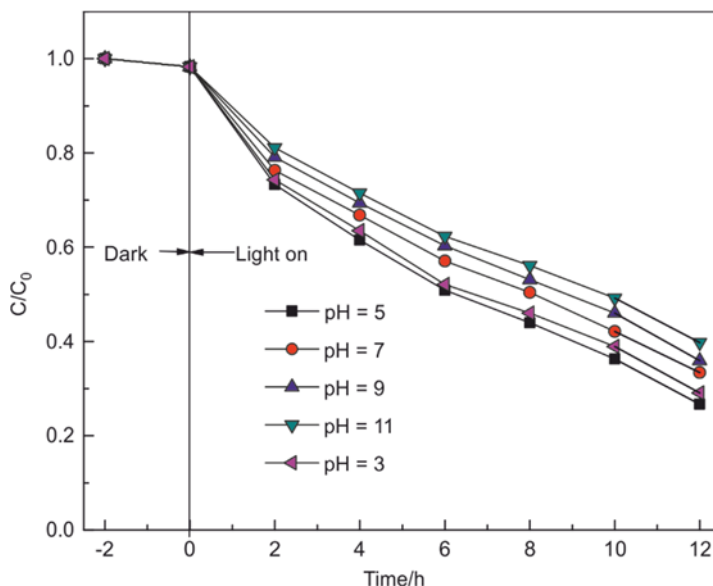

Fig. 3. Effect of initial pH on PEC degradation of diclofenac by N, S-TiO₂ NCs/TiO₂ NTAs photoelectrode; initial diclofenac concentration 5 mg·dm⁻³, Na₂SO₄ concentration 0.10 mol·dm⁻³, external potential 0.4 V (vs. SCE)

The highest PEC performance was achieved at pH 5. As demonstrated [21], diclofenac molecule possessed amino ($-\text{NH}_2$) group at low pH while carboxyl ($-\text{COOH}$) group at high pH. Besides, isoelectric point of TiO₂ was 6.2 [22]. When pH was lower than 6.2, the photoelectrode displayed electro-positivity, which could easily adsorb electronegative contaminants. Conversely, once the pH was higher than 6.2, TiO₂ exhibited electronegativity, which was not benefit for the adsorption of pollutants. In addition, it should be noted that the surface hydroxyl ions ($-\text{OH}$) could also be substituted by Na⁺, leading the formation of $-\text{ONa}$, resulting in the reduction of surface $\bullet\text{OH}$ radicals and PC performance [23]. The highest PEC performance could be obtained when pH was close to $\text{p}K_a$ (4.35) of diclofenac. At this point, diclofenac existed as zwitter-ion. Thus, the initial pH of the solution in the following experiments was 5 without special explanations.

3.2. DYNAMIC CHARACTERISTICS OF PEC DEGRADATION OF DICLOFENAC

Effect of external potential on the degradation of diclofenac has been investigated. As demonstrated in our previous studies [24], applied potential could facilitate the migration of photoinduced electrons through the internal circuit from photoanode to cathode, resulting in an enhanced PEC efficiency.

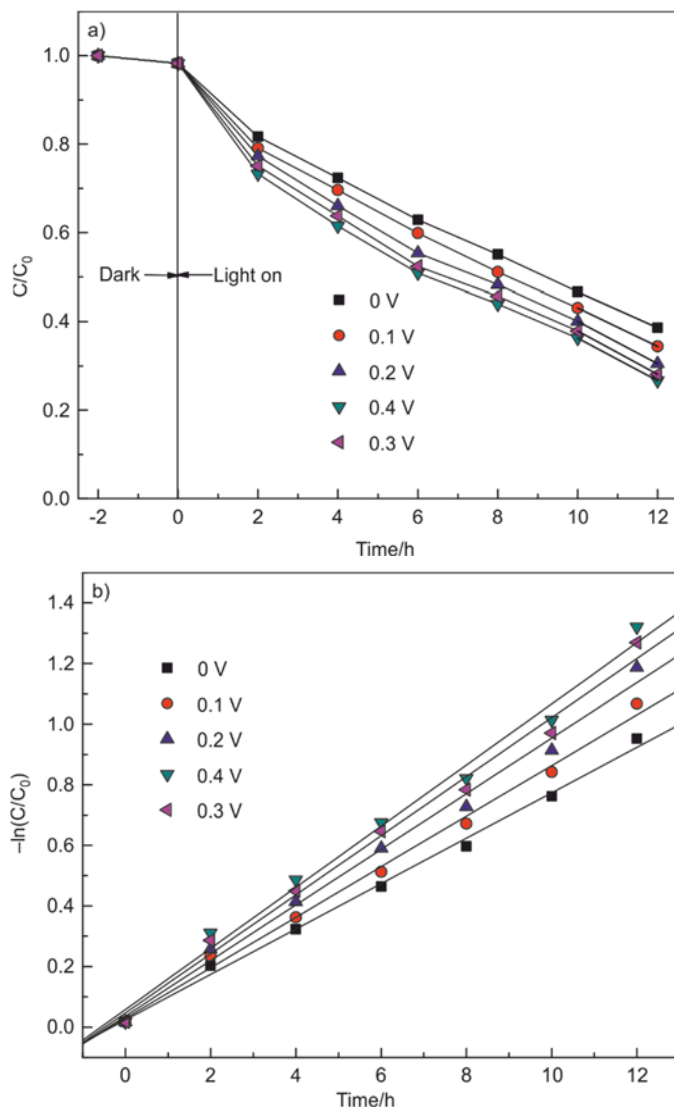

Fig. 4. Effect of external potential on the PEC degradation of diclofenac (a) and evolution curves (b) by N, S-TiO₂ NCs/TiO₂ NTAs photoelectrode; diclofenac initial concentration 5 mg·dm⁻³, Na₂SO₄ concentration 0.10 mol·dm⁻³, pH 5

As can be seen from Fig. 4a, the PEC efficiency was gradually increased upon increasing applied potential, indicating that the separation efficiency of charge carriers was improved. The highest PEC performance occurred at 0.4 V, when 71.4% of PEC efficiency for degradation of diclofenac could be achieved, apparently larger than that of 61.4% in the absence of applied potential. The PEC degradation curves of diclofenac were fitted and shown in Fig. 4b. It was found that the PEC degradation of diclofenac fitted well with the pseudo-first-order kinetics formula according to the Langmuir–Hinshelwood (L–H) model [19]. The apparent first-order constant (k) and square of the regression coefficient (R^2) at various potentials applied (U) are listed in Table 1. When the applied potential was 0.4 V, the highest rate constant (0.1009 h^{-1}) was obtained, which was in accordance with the Liu's [25] results for PC degradation of tetracycline.

Table 1

Photoelectrocatalytic degradation rate constants k of diclofenac over N, S-TiO₂ NCs/TiO₂ NTAs photoelectrode at various external potentials U

U [V]	k [h^{-1}]	R^2	U [V]	k [h^{-1}]	R^2
0.1	0.08345	0.9944	0.3	0.09747	0.9902
0.2	0.09174	0.9918	0.4	0.10090	0.9892

The relation between k and U could be described by the following equation:

$$k = k_1 U^a \quad (3)$$

where k_1 and a are constants, which can be calculated from the data in Table 1, i.e.,

$$k = 0.1148U^{0.1383} \quad (4)$$

In order to decrease the resistance of solution and increase the transfer of electrons and current efficiency, a certain concentration of supporting electrolyte is necessary during electrochemical reactions [26]. Therefore, the effect of sodium sulfate concentration on the PEC degradation of diclofenac was studied. As shown in Fig. 5, with the addition of sodium sulfate, PEC efficiency was increased upon increasing sodium sulfate concentration, which was ascribed to the improvement of electroconductivity of solution. The PEC processes were also fitted well with the L–H model. The apparent first-order constants (k) and square of the regression coefficients (R^2) at various concentrations of sodium sulfate (C_1) are given in Table 2.

The relationship between k and C_1 could be described by the equation:

$$k = k_2 C_1^b \quad (5)$$

k_2 and b are constants, which can be calculated from the data in Table 2, i.e.,

$$k = 0.1252C_1^{0.1021} \quad (6)$$

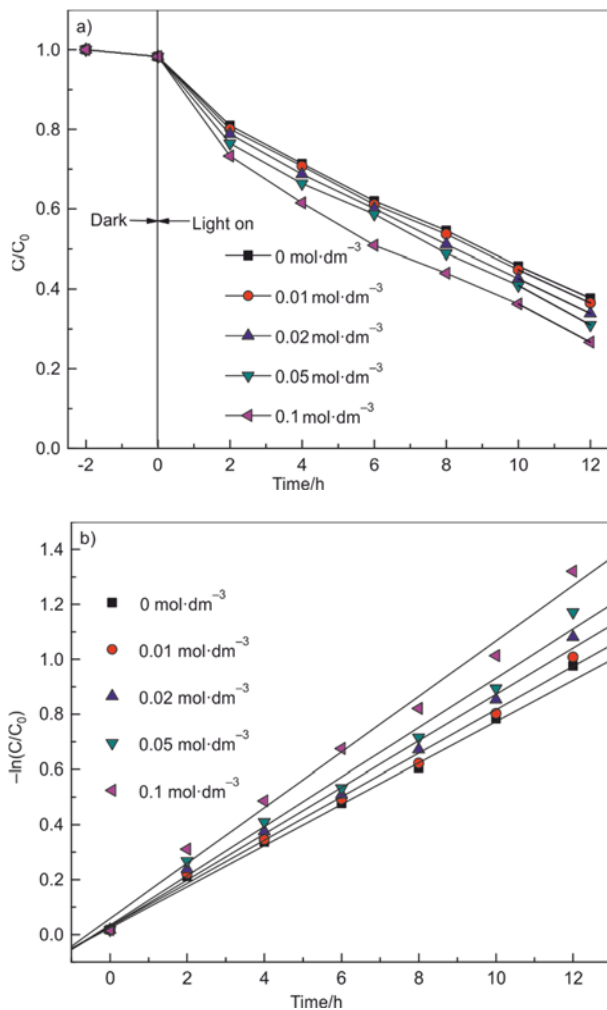

Fig. 5. Effect of concentration of sodium sulfate on the PEC degradation of diclofenac (a) and evolution curves (b) by N, S-TiO₂ NCs/TiO₂ NTAs photoelectrode; initial diclofenac concentration 5 mg·dm⁻³, pH 5, external potential +0.4 V (vs. SCE)

Table 2

Photoelectrocatalytic degradation rate constants k of diclofenac over N, S-TiO₂ NCs/TiO₂ NTAs photoelectrodes at different concentration of sodium sulfate C_1

C_1 [mol·dm ⁻³]	k [h ⁻¹]	R^2	C_1 [mol·dm ⁻³]	k [h ⁻¹]	R^2
0.01	0.07876	0.9940	0.05	0.08965	0.09874
0.02	0.08428	0.9930	0.10	0.1009	0.9892

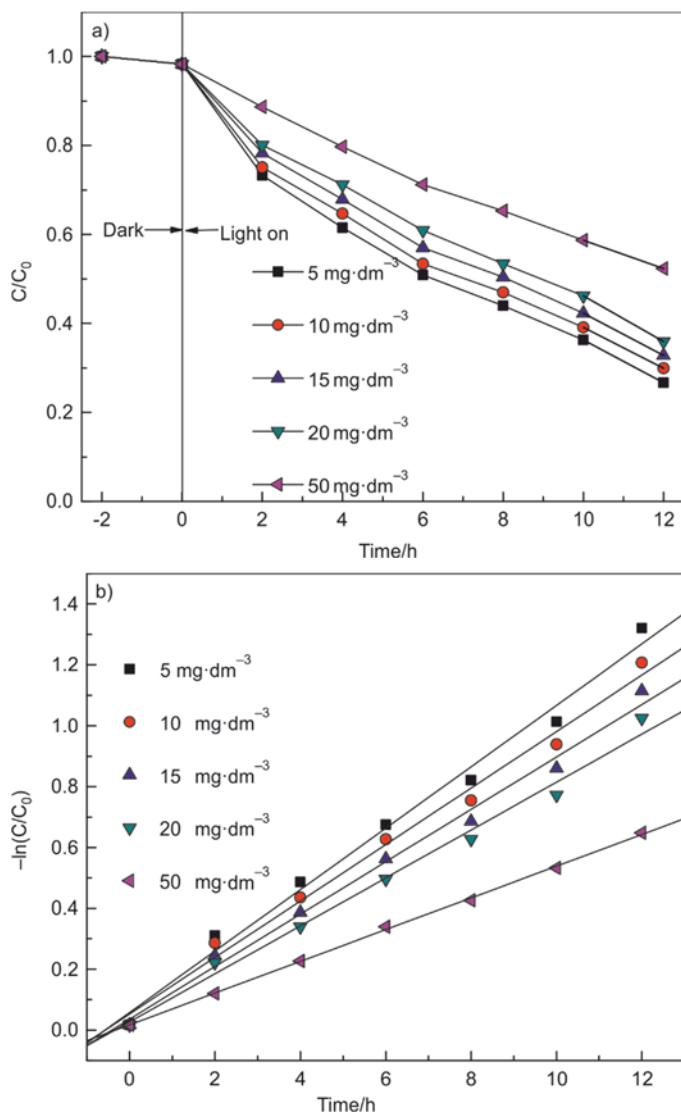

Fig. 6. Effect of initial concentration of diclofenac on the PEC performance (a) and evolution curves (b) by N, S-TiO₂ NCs/TiO₂ NTAs photoelectrode; Na₂SO₄ concentration 0.10 mol·dm⁻³, pH 5.0, external potential 0.4 V (vs. SCE)

The influence of initial concentration of diclofenac on the PEC efficiency has also been investigated. Photoelectrochemical reactions and adsorption-desorption processes of pollutants on the surface of nanocatalysts proceed often during the degradation of pollutants. As displayed in Fig. 6, the PEC performance of N, S-TiO₂ NCs/TiO₂ NTAs

photoelectrode was conversely decreased with the enhancement of diclofenac concentration. This phenomenon was attributed to the diminishing of reactive sites at high diclofenac concentrations. Also, the PEC processes were fitted well with the L–H model. The apparent first-order constant (k) and squares of the regression coefficients (R^2) at various concentrations of diclofenac (C_2) are given in Table 3.

Table 3

Photoelectrocatalytic degradation rate constants of diclofenac over N, S-TiO₂ NCs/TiO₂ NTAs photoelectrodes at various concentrations of diclofenac C_2

C_2 [mg·dm ⁻³]	k [h ⁻¹]	R^2	C_2 [mg·dm ⁻³]	k [h ⁻¹]	R^2
5	0.1009	0.9892	20	0.07875	0.9901
10	0.09278	0.9907	50	0.05211	0.9993
15	0.08611	0.9919			

The relation between k and C_2 could be described by the following equation:

$$k = k_3 C_2^c \quad (7)$$

where k_3 and c are constants which can be calculated from the data in Table 3, i.e.,

$$k = 0.1746 C_2^{-0.2878} \quad (8)$$

The apparent rate constant k has been determined for the potential 0.4 V, initial concentrations of sodium sulfate 0.10 mol·dm⁻³ and of diclofenac 5 mol·dm⁻³; k_4 was 0.1824. Thus, k of could be further expressed as

$$k = 0.1824 k_4 U^{0.1383} C_1^{0.1021} C_2^{-0.2878} \quad (9)$$

It results from Eq. (9) that the factors affecting degradation of diclofenac ranked from the strongest to the weakest one are potential, concentration of sodium sulfate, and initial concentration of diclofenac.

The kinetic equation of PEC degradation of diclofenac solution using N, S-TiO₂ NCs/TiO₂ NTAs photoelectrode as a photoanode can be demonstrated as follows

$$-\ln \frac{C}{C_0} = 0.1824 k_4 U^{0.1383} C_1^{0.1021} C_2^{-0.2878} \quad (10)$$

Therefore, in order to test the accuracy of Eq. (10), theoretical values of $\ln(C/C_0)$ calculated from this equation have been compared with the experimental values. As shown in Fig. 7, a good compliance has been obtained.

3.3. EFFECT OF EXTERNAL ANIONS ON THE PEC DEGRADATION OF DICLOFENAC

Metal ions play a complex role in the degradation of organic pollutants, displaying either synergistic effect or inhibiting action [27]. Ca^{2+} ions could cause the hardness of water, thus, calcium salt such as $\text{Ca}(\text{NO}_3)_2$, CaCl_2 and $\text{Ca}(\text{ClO})_2$ were selected to investigate the influence of different anions on the PEC degradation of diclofenac.

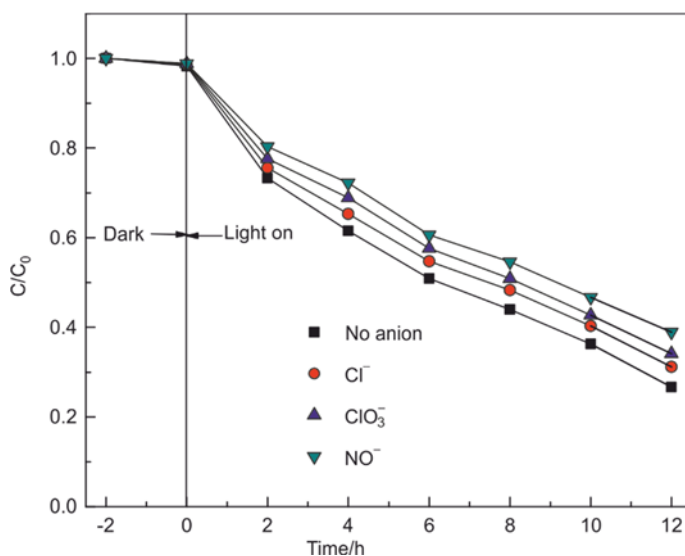

Fig. 8. Effect of various anions ($0.05 \text{ mol}\cdot\text{dm}^{-3}$) of on the PEC degradation of diclofenac by N, S- TiO_2 NCs/ TiO_2 NTAs photoelectrode; initial diclofenac concentration $5 \text{ mg}\cdot\text{dm}^{-3}$, Na_2SO_4 concentration $0.10 \text{ mol}\cdot\text{dm}^{-3}$, pH 5.0, external potential 0.4 V (vs. SCE)

As can be seen from Fig. 8, PEC performances of N, S- TiO_2 NCs/ TiO_2 NTAs were all decreased with the addition of the calcium salt. This phenomenon can be explained by the fact that ions could capture the active sites on the surface of N, S- TiO_2 NCs/ TiO_2 NTAs photoelectrode and cause high polarity of the environment by competitive adsorption. Cl^- and ClO^- could even consume photoinduced holes, resulting in a great decrease of the photon-quantum efficiency.

3.4. STABILITY

The stability of electrodes is a key and crucial parameter for recycling in practical applications. In order to confirm the possibility of recycle utilization of N, S- TiO_2 NCs/ TiO_2 NTAs photoelectrode, several consecutive cycles of experiments have been conducted. As shown in Fig. 9, we can clearly see that the PEC efficiency for degrada-

tion of diclofenac by N, S-TiO₂ NCs/TiO₂ NTAs photoelectrode was remained approximately constant even after five recycles, suggesting that the photoelectrode was very stable, which could be used in applied in wastewater treatment.

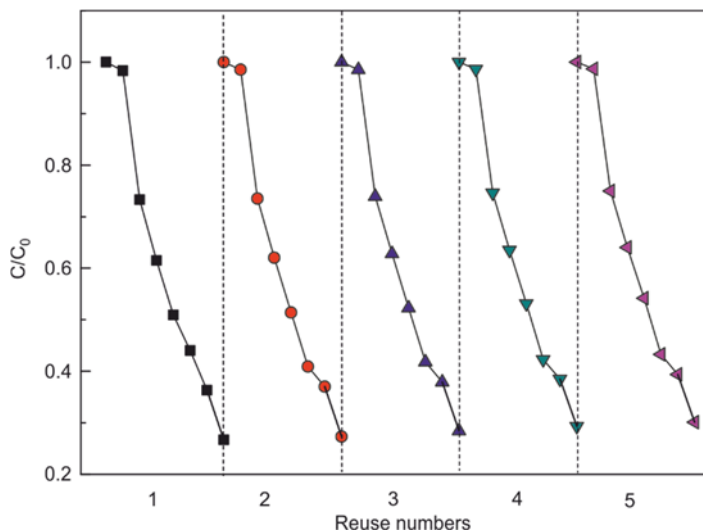

Fig. 9. Cycling runs in the PEC degradation of diclofenac solution in the presence of N, S-TiO₂ NCs/TiO₂ NTAs photoelectrode under 35 W Xenon light irradiation; initial diclofenac concentration 5 mg·dm⁻³, Na₂SO₄ concentration 0.10 mol·dm⁻³, pH 5.0, external potential 0.4 V (vs. SCE)

4. CONCLUSIONS

The as-fabricated N, S co-doped TiO₂ nano-crystallite decorated TiO₂ nano-tube arrays photoelectrode exhibited high PEC performance for degradation of diclofenac. The highest PEC performance of 71.4% could be achieved at the optimized pH 5. In addition, some critical parameters can affect the PEC activity of diclofenac. According to the kinetic equation $\ln(C/C_0) = 0.1824(U)^{0.1383} \cdot (C_1)^{0.1021} \cdot (C_2)^{-0.2878} t$, the factors affecting the PEC degradation of diclofenac ranked from the strongest to the weakest one were potential, concentration of sodium sulfate and initial concentration of diclofenac. External anions played also an important role in inhibiting the PEC performance. N, S-TiO₂/TiO₂ NTAs photoelectrode displayed a good stability during repeated reactions of degradation of diclofenac, which could potentially be used in water treatment.

ACKNOWLEDGMENTS

This project was funded by the National Natural Science Foundation of China (51508254, 21407071), Nature Science Foundation of Gansu Province of China (1506RJZA216), Fundamental Research Funds for

the Central Universities (lzujbky-2015-137), Open Fund by Jiangsu Engineering Technology Research Center of Environmental Cleaning Materials (KFK1502), A Project Funded by the Priority Academic Program Development of Jiangsu Higher Education Institutions (PAPD), Opening Project of State Key Laboratory of High Performance Ceramics and Superfine Microstructure (SKL201509SIC) and Key Laboratory of Comprehensive and Highly Efficient Utilization of Salt Lake Resources, Qinghai Institute of Salt Lake, Chinese Academy of Sciences.

REFERENCES

- [1] LANDSDORP D., VREE T.B., HANSEN T.J., GUELEN P.J.M., *Pharmacokinetics of rectal diclofenac and its hydroxyl metabolites in man*, Int. J. Clin. Pharm., Ther. Toxicol., 1990, 28, 298.
- [2] HIRSCH R., TERNES T., HABERER K., KRATZ K.L., *Occurrence of antibiotics in the aquatic environment*, Sci. Total Environ., 1999, 225, 109.
- [3] HAAP T.T., KÖHLER R.H.R., *Acute effects of diclofenac and DMSO to Daphnia magna. Immobilisation and hsp70-induction*, Chemosphere, 2008, 73, 353.
- [4] TAGGGART M.A., CUTHBERT R., DAS D.K., MEHARG A.A., *Diclofenac disposition in Indian cow and goat with reference to Gyps vulture population declines*, Environ. Pollut., 2007, 147, 60.
- [5] MEHINTO A.C., HILL E.M., TYLER C.R., *Uptake and biological effects of environmentally relevant concentrations of the nonsteroidal anti-inflammatory pharmaceutical diclofenac in rainbow trout (oncorhynchus mykiss)*, Environ. Sci. Tech., 2010, 44, 2176.
- [6] CLEUVERS M., *Mixture toxicity of the anti-inflammatory drugs diclofenac, ibuprofen, naproxen, and acetylsalicylic acid*, Ecotox. Environ. Safe., 2004, 59, 309.
- [7] HUBER M.M., CANONICA S., PARK G.Y., GUNTEN U.V., *Oxidation of pharmaceuticals during ozonation and advanced oxidation processes*, Environ. Sci. Tech., 2003, 37, 1016.
- [8] BERNABEU A., VERCHER R.F., SANTOS-JUANES L., SIMÓN P.J., LARDÍN C., MARTÍNEZ M.A., VICENTE J.A., GONZÁLEZ R., LLOSÁ C., ARGUES A., AMAT A.M., *Solar photocatalysis as a tertiary treatment to remove emerging pollutants from wastewater treatment plant effluents*, Catal. Today, 2011, 161, 235.
- [9] LINSEBIGLER A.L., LU G.Q., YATES Y.T., *Photocatalysis on TiO₂ surfaces: principles, mechanisms, and selected results*, Chem. Rev., 1995, 95, 735.
- [10] SHIN K., SEOK S., IM S.H., PARK J.H., *CdS or CdSe decorated TiO₂ nanotube arrays from spray pyrolysis deposition. Use in photoelectrochemical cells*, Chem. Commun., 2010, 46, 2385.
- [11] CHENG X.W., LIU H.L., YU X.J., CHEN Q.H., LI J.J., WANG P., UMAR A., WANG Q., *Preparation of highly ordered TiO₂ nanotube array. Photoelectrode for the photoelectrocatalytic degradation of Methyl Blue. Activity and mechanism study*, Sci. Adv. Mater., 2013, 5, 1563.
- [12] CHENG X.W., PAN G.P., YU X.J., ZHENG T., UMAR A., WANG Q., *Effect of post-annealing treatment on photocatalytic and photoelectrocatalytic performances of TiO₂ nano-tube arrays photoelectrode*, J. Nanosci. Nanotechn., 2013, 13, 5580.
- [13] CHENG X.W., LIU H.L., CHEN Q.H., LI J.J., WANG P., *Enhanced photoelectrocatalytic performance for degradation of diclofenac and mechanism with TiO₂ nano-particles decorated TiO₂ nano-tubes arrays photoelectrode*, Electrochim. Acta, 2013, 108, 203.
- [14] CHENG X.W., LIU H.L., CHEN Q.H., LI J.J., WANG P., *Construction of N, S co-doped TiO₂ NCs decorated TiO₂ nano-tubes arrays photoelectrode and its enhanced visible light photocatalytic mechanism*, Electrochim. Acta, 2013, 103, 134.
- [15] CHENG X.W., LIU H.L., CHEN Q.H., LI J.J., WANG P., *Preparation and characterization of palladium nano-crystallite decorated TiO₂ nano-tubes photoelectrode and its enhanced photocatalytic efficiency for degradation of diclofenac*, J. Hazard. Mater., 2013, 254, 141.
- [16] CHENG X.W., LIU H.L., CHEN Q.H., LI J.J., WANG P., *Preparation of graphene film decorated TiO₂ nanotube array photoelectrode and its enhanced visible light photocatalytic mechanism*, Carbon, 2014, 66, 450.

- [17] OLIVEIRA H.G., NERY D.C., LONGO C., *Effect of applied potential on photocatalytic phenol degradation using nanocrystalline TiO₂ electrodes*, Appl. Catal. B-Environ., 2010, 93, 205.
- [18] ZHU K., NEALE N.R., MIEDANER A., FRANK A.J., *Enhanced charge-collection efficiencies and light scattering in dye-sensitized solar cells using oriented TiO₂ nanotube arrays*, Nano Letters, 2007, 7, 69.
- [19] HOFFMAN M.R., MARTIN S.T., CHIO W.Y., BAHNEMANN D.W., *Environmental application of semiconductor photocatalysis*, Chem. Rev., 1995, 95, 69.
- [20] KORMANN C., BAHNEMANN D.W., HOFFMANN M.R., *Photolysis of chloroform and other organic molecules in aqueous TiO₂ suspensions*, Environ. Sci. Tech., 1991, 25, 494.
- [21] ZHANG N., LIU G.G., LIU H.J., WANG Y.L., HE Z.W., WANG G., *Diclofenac photodegradation under simulated sunlight. Effect of different forms of nitrogen and kinetics*, J. Hazard. Mater., 2013, 2011, 192, 411.
- [22] WU S.J., HAN H.W., TAI Q.D., ZHANG J., XU S., ZHOU C., YANG Y., HU H., CHEN B., SEBO B., ZHAO X.Z., *Enhancement in dye-sensitized cells based on MgO-coated TiO₂ electrodes by reactive DC magnetron sputtering*, Nanotechn., 2008, 19, 215704.
- [23] HU C., YU J.C., HAO Z.P., WONG P.K., *Effects of acidity and inorganic ions on the photocatalytic degradation of different azo dyes*, Appl. Catal. B-Environ., 2003, 46, 35.
- [24] CHENG X.W., PAN G.P., YU X.J., *Visible light responsive photoassisted electrocatalytic system based on CdS NCs decorated TiO₂ nano-tube photoanode and activated carbon containing cathode for wastewater treatment*, Electrochim. Acta, 2015, 156, 94.
- [25] LIU Y.B., GAN X.J., ZHOU B.X., XIONG B.T., LI J.H., DONG C.P., BAI J., CAI W.M., *Photoelectrocatalytic degradation of tetracycline by highly effective TiO₂ nanopore arrays electrode*, J. Hazard. Mater., 2013, 171, 678.
- [26] LEE K.Y., KIM J.Y., KIM H., LEE Y.J., TAK Y.S., *Effect of electrolyte conductivity on the formation of a nanotubular TiO₂ photoanode for a dye-sensitized solar cell*, J. Korean Phys. Soc., 2009, 54, 1027.
- [27] GAO T., QIAN C.Y., *The development of organic pollutants in water in TiO₂ photocatalytic oxidation*, Industrial Water Treatment, 2000, 20, 10.