

G. BOCZKAL*

STRUCTURE AND PROPERTIES OF Zn-Ti0.2-Cu0.15 SINGLE CRYSTAL CONTAINING EUTECTIC PRECIPITATES

STRUKTURA I WŁASNOŚCI MONOKRYSTAŁÓW Zn-Ti0.2-Cu0.15 ZAWIERAJĄCYCH WYDZIELENIA EUTEKTYCZNE

Some structure observations for the Zn-Ti0.2-Cu0.15 single crystal obtained by the Bridgman method are presented. The structure contains (Zn) – phase with inclusions of Zn₁₆Ti inter-metallic compound. The Zn₁₆Ti intermetallic compound is localized within the eutectic precipitates. A morphology of the Zn₁₆Ti compound varies according to the solidification condition imposed during the single crystal growth. The block, great size particles are a characteristic element for the alloy which composition is situated nearly the eutectic point in the phase diagram. These particles were not observed previously in the hypoeutectic Zn-Ti alloys. Mechanical properties of the obtained single crystals are also investigated. Critical resolved shear stress (CRSS) during deformation in a basal slip system (0001)<11-20> is determined. The changes of the CRSS for the Zn-Ti0.2-Cu0.15 single crystals within the range of temperatures from 200K to 370K are presented. The obtained data are compared with previously investigated results for the (Zn) single crystals containing lower (hypoeutectic) titanium addition.

Keywords: hexagonal single crystals, primary phase, eutectic precipitates

W pracy przedstawiono wyniki badań strukturalnych i mechanicznych monokrystałów Zn-Ti0.2-Cu0.15 otrzymanych metodą Bridgmana. Struktura badanego stopu składała się z monokryształicznej osnowy – fazy (Zn) oraz cząstek fazy międzymetalicznej Zn₁₆Ti. Cząstki fazy międzymetalicznej Zn₁₆Ti zlokalizowane były wewnątrz eutektyki. Morfologia fazy Zn₁₆Ti ulegała zmianom w zależności od warunków krystalizacji zastosowanych podczas wzrostu monokrystałów. Blokowe cząstki o dużych rozmiarach stanowiły charakterystyczny element struktury stopu o składzie zbliżonym do punktu eutektycznego na diagramie fazowym, i nie były wcześniej obserwowane dla monokrystałów podeutektycznych stopów Zn-Ti oraz Zn-Ti-Cu. Zbadano własności mechaniczne otrzymanych monokrystałów. Wyznaczono krytyczne naprężenie ścinające (KNŚ) osiągnięte podczas deformacji próbek w systemie łatwego poślizgu (0001)<11-20>. KNŚ krystałów Zn-Ti0.2-Cu0.15 wyznaczone w zakresie temperatury od 200K do 370K osiągało wartości odpowiednio od 12 MPa do 6 MPa. Uzyskane wyniki porównano z rezultatami wcześniejszych badań na monokrystałach (Zn) z podeutektyczną zawartością tytanu.

1. Introduction

The work discusses the relatively poorly investigated area of various phenomena accompanying monocrystallization of hexagonal metal alloys containing second phase inclusions in the structure. Metals of hcp structure form a not very numerous but having a fundamental industrial importance group.

Hexagonal metals are characterised by large stress variations in the different types of slip systems [1]. With proper orientation respective of the stress applied, these metals can be deformed in one system, operating as a primary system, obtaining a wide range of the deformation values [1-6]. It is typical, in particular, of metals having the *c/a* ratio >1.633, such as zinc and cadmium. Zinc single crystals of "soft" orientation are deformed to more than 100% (elongation) within the range of an easy slip in a (0001) <11-20> system. Only a very serious change of orientation caused by deformation and the strong strain hardening effect in the basal system of (0001) <11-20> are capable of activating a different slip arrangement [1,5,6].

In hexagonal metals there are three directions preferred by the diffusion; these are the directions of the close packed <11-20> located in a base of hexagonal cell on the plane (0001). These are also the privileged directions for the growth of a single crystal structure. This tendency is the stronger the higher is the imposed from the outside crystallisation rate and the higher is the content of alloying elements. In the case of single crystals grown without a nucleus, this means a constant axial orientation consistent with the direction [11-20]. This effect is so strong that all attempts at obtaining an orientation different than the one preferred by the growth mechanism require, beside the presence of a nucleus of the desired orientation, also the crucible of special design [7].

Alloys based on hexagonal metals offer low solubility to other metals in the solid state and a tendency to create numerous intermetallic phases (Fig. 1) [8-13].

The structural anisotropy strongly influences the mode of nucleation and growth of the secondary phases in single crystals with a hexagonal structure. The large difference in

* AGH – UNIVERSITY OF SCIENCE AND TECHNOLOGY, FACULTY OF NON-FERROUS METALS, AL.MICKIEWICZA 30, 30-059 KRAKÓW, POLAND

elastic constants at different crystallographic directions of the hcp lattice [14,15] enforces some permanent relationships between the crystal lattice of the newly emerging intermetallic phases and matrix.

Moreover, growth conditions (cooling rate and temperature gradient) during Bridgman crystallization determined type of generated structure [20]. Previous investigations showed transition of the second phase distribution from oscillatory structure for small growth rates, by continuous structure, to cell structure for the possibly highest growth rate. In the same time, morphology of the $Zn_{16}Ti$ phase evaluated property from rod, by plates, to the needle form [20]. These phenomena changes can be explained by a model created on the basis of thermodynamic of non-inversion processes, using the criterion of minimal production of entropy [16-18].

2. Methodology

Single crystals of $Zn-Ti0.2-Cu0.15$ used in study were grown by Bridgman method with moving temperature gradient. Bridgman's original method [22], which consists in lowering a crucible with a charge inside through the zone of strong temperature gradient, was modified by application of the sliding motion of the furnace, while the nucleus and the charge were left immobile.

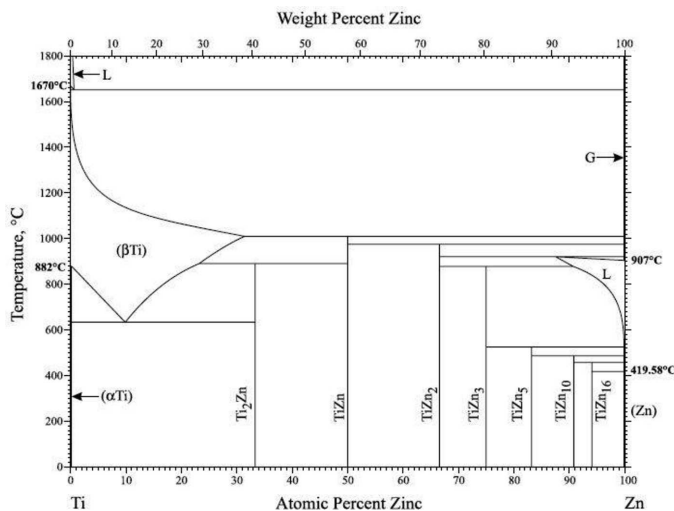

Fig. 1. Zn-Ti phase diagram, Okamoto 2008 [8]

The growth process was carried out in crucibles made of spectrally pure graphite with growth rate of **3.6 mm/h**. To prevent oxidation and also a reaction between the charge and the crucible material, an argon protective atmosphere was used. Permanent purging of the furnace chamber allowed the removal of oxygen and unwanted gaseous products formed during melting of charge. The resulting single crystals were oriented with a Bruker D8 Advance X-ray diffractometer, and were cut next into specimens with orientation of the observation planes (0001) and (11-20), respectively. The surfaces of the specimens were pre-polished with abrasive papers and diamond paste and followed by etching with a chromium reagent. To reveal the shape of precipitates and determine the crystallographic relationship with the matrix, deep selective etching was used. Structural examinations were performed under Hi-

tachi S-3400N scanning microscope with an EDS and EBSD attachments, and under the TESLA-302 microscope.

Mechanical investigations were performed for two variants of sample orientation: **30°** and **60°** between compression axis and [11-20]. The cut off method is presented in Figure 2.

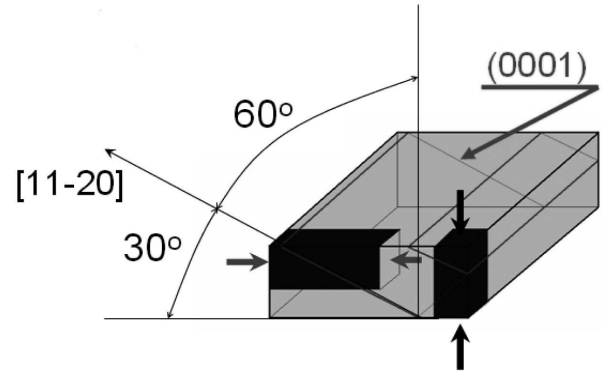

Fig. 2. Primary single crystal and cut off method of samples for the compression test

The samples have had dimensions of $3 \times 3 \times 6$ mm. Deformation was made in compression test at strain rate of $10^{-3} s^{-1}$ in temperature range from 77K to 350K. Load cell range of strength machine was 5kN.

3. Results and discussions

The studied single crystals of eutectic composition are characterized by presence of only one intermetallic phase, namely $Zn_{16}Ti$ [19]. The phase is characterized by tetragonal structure and left in a constant relation to the hexagonal matrix [2-4,7]. This is an analogous situation to that existing in the previously studied single crystals of hypoeutectic content of titanium. The differences regard the observed morphology of precipitates of the second phase. In the single crystals of the hypoeutectic composition, especially $Zn-Ti0.1-Cu0.1$, it is possible to steer morphology and distribution of the precipitates in wide range, however in the whole volume of such single crystal only one morphological type of precipitates is present (Figure 3). The exception is moment of transformation plates \rightarrow fibers, when two phases coexist occupying however separate regions but thermodynamically equivalent at the crystallization stage.

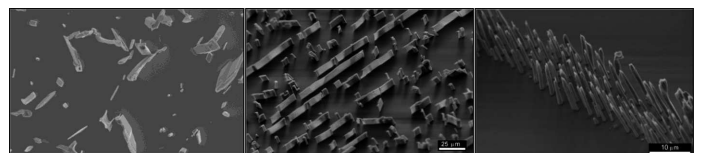

Fig. 3. The various morphologies of the $Zn_{16}Ti$ intermetallic phase [7]

In case of the $Zn-Ti0.2-Cu0.15$ single crystals, the situation is more complicated: two morphological types of precipitates coexist in the volume of the crystal, however their shape is different. They may take shape of previously observed needles or 'macro-particles' of the size and volume of more than one order of magnitude larger.

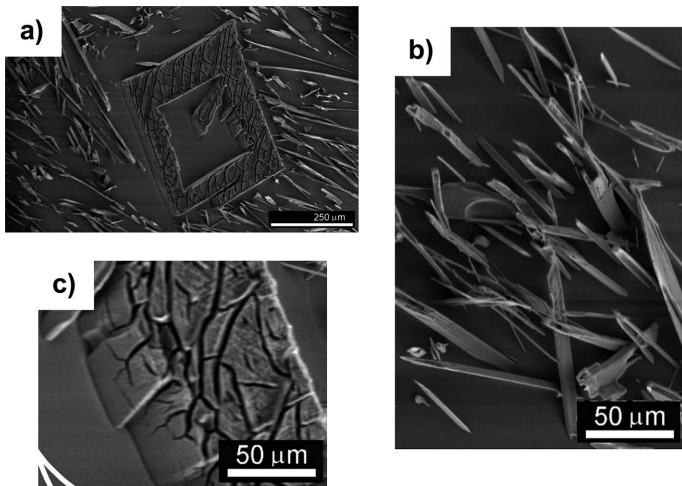
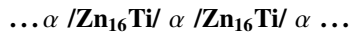

Fig. 4. The block macro-particle (c) and needle-shaped forms (b) of the $Zn_{16}Ti$ phase

The suggested mechanism of formation of massive particles bases on conjugate growth of the eutectic phase. The growth of a single crystal by Bridgman method is associated by continuous changes of concentration of an alloying element in front of crystallization front analogous to those present in case of zone refining. Additionally, the crystallization front does not form an ideal equi-potential plane but it is submitted to thermal fluctuations. The local combination of chemical composition and temperature gradient may be responsible for optimal conditions for the conjugate growth of the eutectic phases due to which the macroparticles are formed. As an indirect proof may be recalled here the structure of such particles:



where the α and intermetallic phase alternate, while one of them, $Zn_{16}Ti$, dominates.

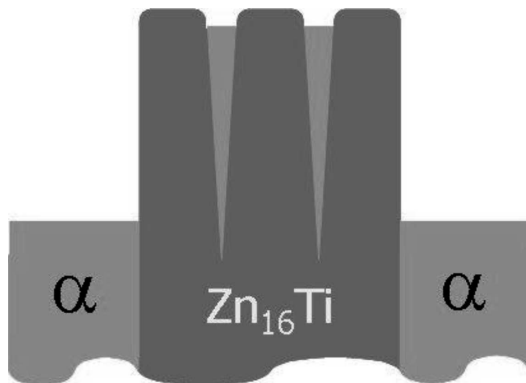

Fig. 5. Model of the block macro-particle

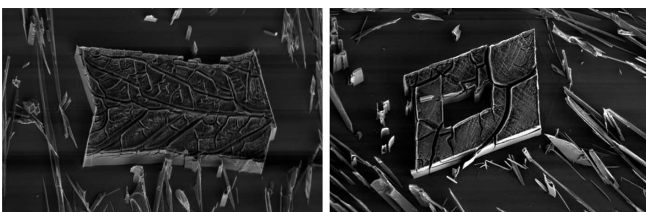

Fig. 6. Examples of different block (macroparticles) forms observed on the (0001) plane

The zinc single crystals containing the precipitates of the second phase in the structure form a semi-composite material. The previous studies showed that the deformation processes take place mostly in matrix [2-4]. Simultaneously the presence of anomaly of hardening coefficient and CRSS were observed. Now, the question appeared, whether increase of amount of the second phase may influence the process of deformation. The single crystals of eutectic composition have the structure characterized by high degree of concentration of the $Zn_{16}Ti$ precipitates, and, in addition, of different morphology. In order to study the influence of such a semi-composite, second phase arrangement on the mechanical properties, especially on CRSS, two kinds of samples were prepared. The samples differ in a way of applying load with respect to 'skeleton' of the precipitates.

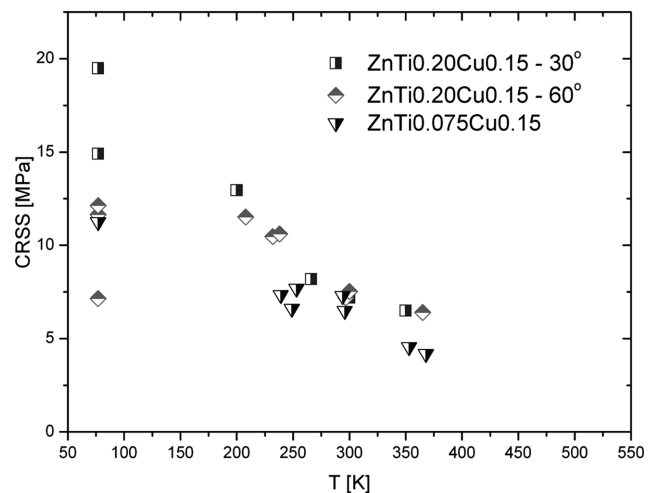

Fig. 7. The CRSS relation to the temperature for two variants of samples orientation. For compare were presented results for Zn-Ti0.075-Cu0.15 single crystals. The anomaly zone was existed only for single crystals with smaller content of titanium

The characteristics of CRSS in function of temperature presented in Figure 7 shows lack of influence of the arrangement of the second phase on CRSS. Additionally, no anomalies in mechanical properties characteristic for alloys of hypoeutectic content of titanium were observed. The previous studies showed, that the anomaly is present within matrix region and it is dependent on the concentration of elements dissolved in it. Therefore, a conclusion can be drawn that the high concentration of precipitates in eutectic single crystals influences the concentration of elements dissolved in matrix in such a way, that activation of mechanisms responsible for formation of an anomaly are impossible.

4. Conclusions

Only one type of the intermetallic phase has been detected, namely $Zn_{16}Ti$ (Fig. 1).

A characteristic feature of structure of those crystals co-existence of two totally different forms of the $Zn_{16}Ti$ phase: needles / fibers (Fig. 4a,b) macroparticles in a eutectic configuration (Figs 4a,c,5,6) $\dots \alpha / Zn_{16}Ti / \alpha / Zn_{16}Ti / \alpha \dots$

Results presented in Fig. 7 showed that initial orientation of the samples is negligible. High concentration of the hardening phase in the matrix does not generate a semi-composite hardening effect. Main role in hardening process in a I stage of deformation plays solution-hardened matrix.

Concentration of the phase is enough to eliminate a **CRSS anomaly** observed in zinc single and poly-crystals with small content of solved alloy components, as in industrial alloy **Zn-Ti0.075-Cu0.15** and **Zn-0.2wt.%(Ga or Ag)** single crystals [6,21].

Acknowledgements

The author acknowledge the support of the Polish Committee for Scientific Research, Grant No. 11.11.180.653.

REFERENCES

- [1] Gustav E.R. Schulze, Metallphysik, Akademie-Verlag, Berlin (1974).
- [2] G. Boczkal, B. Mikułowski, I. Hunsche, C-G. Oertel, W. Skrotzki, Cryst. Res. Technol. **2**, 135-140 (2008).
- [3] B. Mikułowski, G. Boczkal, Arch. Metall. Mater. **54**, 197-203 (2009).
- [4] G. Boczkal, B. Mikułowski, I. Hunsche, C-G. Oertel, W. Skrotzki, Cryst. Res. Technol. **45**, 111 (2010).
- [5] B. Sułkowski, R. Chulist, B. Beausir, W. Skrotzki, B. Mikułowski, Crystal Research and Technology **46**, 439-442 (2010).
- [6] G. Boczkal, Materials Science Forum **674**, 245-249 (2011).
- [7] G. Boczkal, B. Mikułowski, W. Wołczyński, Materials Science Forum **649**, 113-118 (2010).
- [8] H. Okamoto, J of Phase and Equilibria and Diffusion **29**, 2, 211-212 (2008).
- [9] T.B. Massalski, Binary Alloy Phase Diagrams, editor: H. Okamoto, ASM International (1996).
- [10] E.A. Anderson, E.J. Boyle, P.W. Ramsey, Trans. AIME **156**, 278 (1944).
- [11] J.A. Spittle, The Effect of Composition and Cooling Rate on the asCast Microstructure of ZnTi Alloys, Metallography **5**, 423-447 (1972).
- [12] J.A. Spittle, Metallography **6**, 115-121 (1973).
- [13] Von W. Heine, U. Zwicker, Bd. 53, H.6 (1962).
- [14] G.A. Alers, J.R. Neighbours, The elastic constants of zinc between 4.2° and 670°K, J. of Phys and Chem of Solids **7**, 1, 58-64 (1958).
- [15] C.W. Garland, R. Dalven, Elastic Constants of Zinc from 4.2K to 77.6K, Phys.Rev. **111**, 5, 1 (1958).
- [16] W. Wołczyński, Modelling of Transport Phenomena in Crystal Growth. Ed.: Szmyd J.S., Suzuki K., Southampton, Boston, WIT Press (2000).
- [17] W. Wołczyński, Pattern Selection in Crystal Growth, Chapter 9 in the book: Modern Aspects of Bulk Crystal and Thin Film Preparation, pp. 187-212, ed. In Tech, eds N. Kolesnikov & E. Borisenko, Rijeka – Croatia (2012).
- [18] W. Wołczyński, Lamella / Rod Transformation as described by the Criterion of Minimum Entropy Production, International Journal of Thermodynamics **13**, 35-42 (2010).
- [19] M. Saillard, G. Develley, C. Beclé, J.M. Moreau, D. Paccard, The Structure of ZnTi16, Act.Cryst. **37B**, 224-226 (1981).
- [20] G. Boczkal, Modern Aspects of Bulk Crystal and Thin Film Preparation, Chapter 7, Edited by N. Kolesnikov and E. Borisenko, Published by InTech, Rijeka, Croatia (2012).
- [21] B. Mikułowski, Strain Hardening of Zinc Monocrystals with Additions of Silver or Gallium, Metallurgy and Foundry Practice, Scientific Bulletin of Univ. of Mining and Metallurgy **96**, Cracow (1982).
- [22] W.D. Lawson, S. Nielsen, Preparation of Single Crystals, Butterworths Scientific Pub. London (1958).