

Autonomous Instrumentation for Measuring Spontaneous Electromagnetic Emissions in Mining

Krzysztof Maniak¹ and Remigiusz Mydlikowski²

¹ National Institute of Telecommunications, Warsaw, Poland

² Faculty of Electronics, Wrocław University of Science and Technology, Wrocław, Poland

<https://doi.org/10.26636/jtit.2020.145320>

Abstract—This article presents the design of an innovative receiver capable of identifying electric and magnetic components of electromagnetic fields. The receiver senses and records electromagnetic disturbances generated as mine tunnels collapse. It offers excellent operating specification and the ability to sense and log magnetic and electrical component strength values in real time. The paper analyzes the data obtained with the use of a system installed in a working mine and attempts to determine hazards resulting from increased rock stress levels that, cause spontaneous EM emissions.

Keywords—coal mining, electromagnetic field, EM receiver, rock destruction.

1. Introduction

Tunnel collapses continue to be the main hazard faced in hard coal mining, posing the most serious threat to the life and health of miners [1]. Nowadays, miners are less threatened by methane explosions, due to the common use of sensitive gas detectors allowing the personnel to evacuate before critical methane concentration are reached. In the event of the collapse, weak seismic events occurring at hard coal excavation sites may be considered their potential precursors. They result from a cascade-like formation of small and large cracks that eventually lead to the collapse of rock masses. The traditional method of monitoring mine events that may potentially lead to huge rock collapses, is known as the seismic method [2]. In this method, an extensive network of geophones is used. It is operated by personnel responsible for safety of the mine, making the decision on the potential evacuation of miners.

An alternative method capable of forecasting hazards at such locations in a more effective manner consists in sensing electromagnetic field variations. It is based on the fact that rapid increase in the mechanical force exerted within rock leads to weak, spontaneous EM emissions that may be considered a precursor of a potential disaster. This phenomenon occurs also during landslides, providing positive results when correlated with the inclinometric method commonly used in landslide testing [3].

This paper aims to present the design of a compact EM field receiver capable of sensing electric and magnetic field changes, enclosed in a small housing. The receiver may also be used to expand the scope of research on the nature of EM fields generated as the mine. A computer-based analysis of the waveforms recorded that correspond to changes in field strength makes it possible to distinguish between useful signals originating from deposits subject to mechanical stress and interference signals.

Many researchers reported a rapid increase in EM field intensity during hard coal mine collapses [4]–[6]. It is important that such a phenomenon occurs even a few hours before the actual incident, i.e. it offers sufficient time for successful evacuation of the miners from the risk area. These findings were proved in laboratory tests concerned with EM field emissions originating from rock samples subjected to destructive axial pressure [7], [8]. It was observed that the electric waveforms obtained by the sensors during the tests had the form of a series of fading pulses with a continuous frequency spectrum [9]. The literature provides results of works aimed at analyzing the number of pulses within a time period, e.g. within one second, or provides descriptions of research concerned with DC voltage corresponding to instantaneous pulse values. This makes it possible to determine the amplitude of the relevant electromagnetic field components. The frequency band of EM emissions may be determined for individual rock samples tested using the method from paper [10].

2. EM Field Measurement Test Stand

In order to measure electromagnetic signals originating from rocks subjected to destructive mechanical stresses, a laboratory testbed was built, as shown in Fig. 1. Many tests of spontaneous electromagnetic emissions were performed on various types of rocks, such as coal, sandstone, dolomite and magnesite. The amplitudes of EM emissions and their spectral distributions were determined during these studies and were recorded for further analysis.

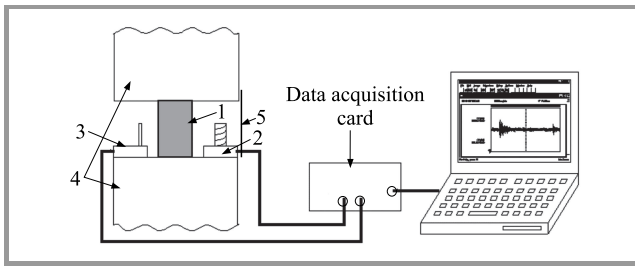

Fig. 1. Setup for recording EM fields generated by rock samples subjected to destructive loads: 1 – test sample, 2 – magnetic field sensor, 3 – electric field sensor, 4 – hydraulic press, 5 – electromagnetic screen.

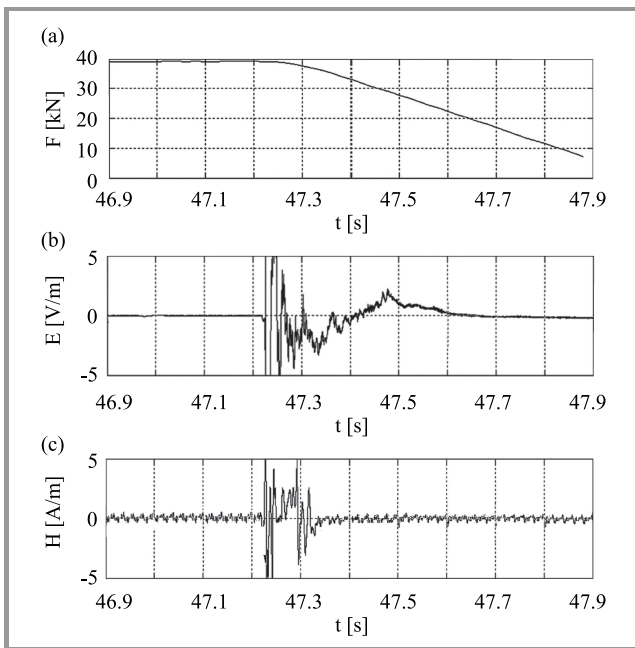

Fig. 2. The recorded EM emission from coal sample during the break process: (a) load applied, (b) electric field value, and (c) magnetic field value.

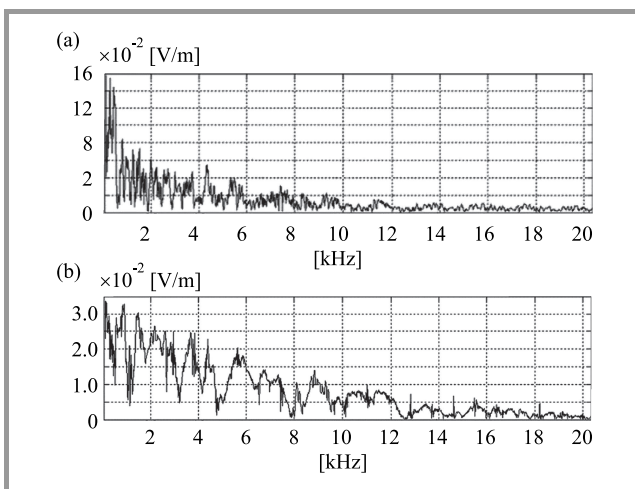

Fig. 3. Frequency spectrum of electrical (a) and magnetic (b) component of the electromagnetic wave emitted by the sample.

During the tests, rocks were placed in a hydraulic press with the maximum force of 450 kN. Two separate sensors (field intensity receivers) measuring the electric and magnetic field components were placed near the press jaws. As suggested in the literature, the broadband EM emissions recording method (up to 100 kHz) was used. To avoid interference, both measurement receivers, as well as the rock sample, were shielded using a flat, grounded plate.

Figure 2 shows examples of EM field signals recorded while testing a cylindrical hard coal sample measuring 30×50 mm. Spectral analysis of the signals is presented in Fig. 3.

3. Autonomous Receiver for EM Field Components Generated by Mine Rocks

Tests carried out in the laboratory indicated that the integrated EM field receiver and recorder, designed to operate in a coal mine environment, should comply with the following specifications [10]:

- minimum electric field component sensitivity of $E_{min} = 2 \cdot 10^{-4}$ V/m and minimum magnetic component sensitivity of $H_{min} = 1.5 \cdot 10^{-5}$ A/m,
- ability to record in the 50 kHz frequency band,
- ability to record real-time signals obtained from sensors, along with peak values,
- built-in power supply for continuous, prolonged operation, e.g. for one month,
- data protection in the event of a power failure,
- no interference with other electronic devices installed in the mine,
- immunity to electromagnetic interference occurring in the mine during its operation,
- IP67 housing and antistatic design,
- mobile enclosure that is easy to install in the mine environment.

A block diagram of the EM field receiver is shown in Fig. 4. The device is made up of four functional components:

- EM field electric signal sensor and signal conditioning circuit,
- EM field magnetic signal sensor and signal conditioning circuit,
- digital signal and control signal processing circuit,
- power supply system.

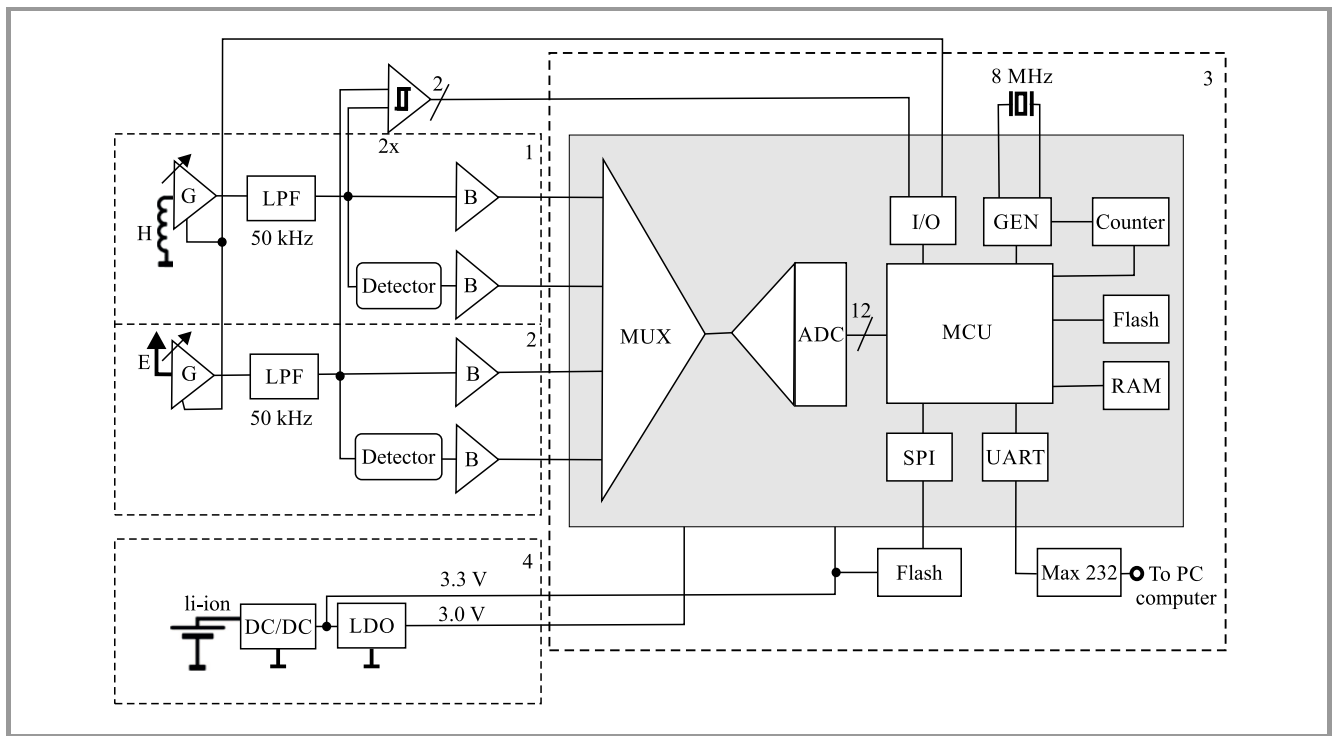

Fig. 4. Block diagram of an integrated EM receiver.

As detectors, two antennas were used: one for the magnetic component and the other for the electric component.

The effective height h_{ef} of the antenna rod is 5 cm, and because $h_{ef} \ll \lambda$ the voltage induced in the antenna is [11]:

$$SEM_E = E \cdot h_{ef} , \quad (1)$$

where E is electric field strength in [V/m].

A ferrite rod antenna coupled with an inductive coil was used as the magnetic component sensor. The induced voltage may be determined from [12], [13]:

$$SEM_H = Z_0 \cdot H \cdot \frac{2\pi \cdot z \cdot S \cdot \mu}{\lambda} , \quad (2)$$

where: H – the magnetic field strength in [A/m], $Z_0=120 \pi \Omega$ – the wave impedance of free space, z – the number of antenna wire turns, S – the cross section area of antenna coil in [m²], λ – the signal wavelength in [m], μ – the magnetic permeability effective value of the antenna’s ferrite core in [H/m].

Sensors with the antennas are located in block 1 and 2, respectively, and form analog signal tracks. In both cases the first part of the conditioning unit has the form of a variable gain amplifier G. Next, the signals received via both tracks are fed to low-pass filters with the cut-off frequency of 50 kHz, and are then passed via buffer B to the ADC converter in MCU. The sampled signal is used to measure the instantaneous value, while the peak value detector gives two additional measurements to ADC via a MUX multiplexer. After digitalization the signals are stored on a Flash

memory card. The recorded data is directly accessible via the RS232 interface.

The digital block with a microcontroller is responsible for signal interpretation and for storing it on a Flash memory card. The MCU used is characterized by low power consumption and allows to update firmware without disassembling the device.

All electronic systems are powered from a 3.3 – 3 V power supply. Therefore, a 3.6 V lithium-ion battery was used. As a DC-DC converter and an LDO regulator are used, the analog part of the system is powered by the voltage of 3 V, while the digital part uses 3.3 V.

The three separated surface-mounted printed circuit boards are combined into a single module by relying on board-to-board mezzanine micro-connectors. The PCB with MCU acts as a base plate to which the analogue blocks with the antennas are attached.

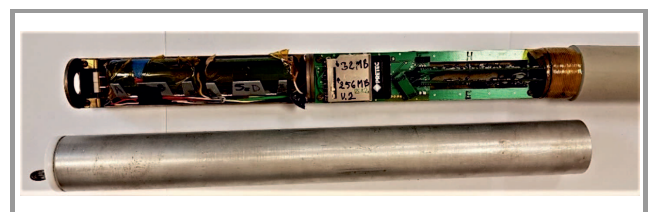

Fig. 5. The integrated electromagnetic field receiver with visible battery and PCBs.

Figure 5 presents the complete receiver unit. It is 500 mm long with 40 mm diameter.

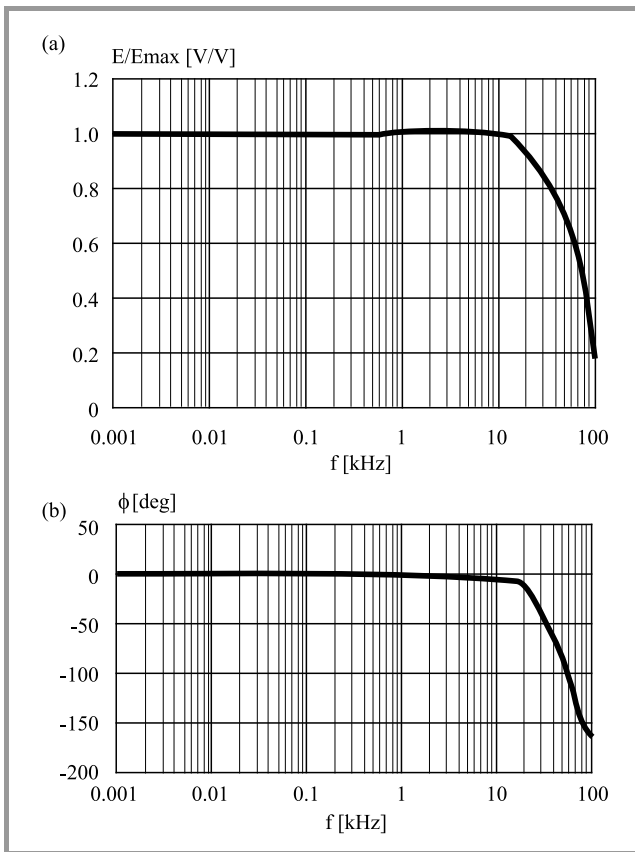

Fig. 6. Frequency characteristics of electric field sensor: (a) relative amplitude sensitivity E/E_{max} , (b) phase response.

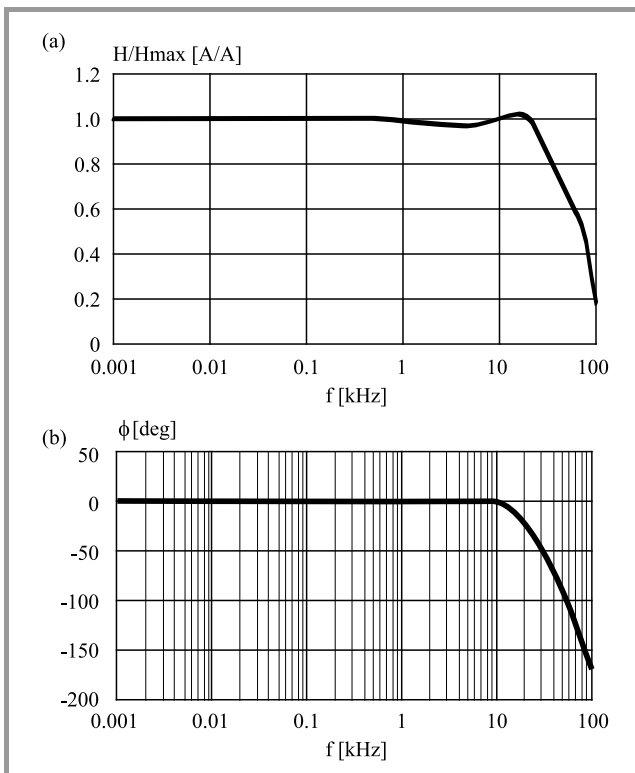

Fig. 7. Frequency characteristics of magnetic field receiver: (a) relative amplitude sensitivity H/H_{max} , (b) phase response.

3.1. Instrument Validation

A series of tests and verification measurements has been performed to determine the operating frequency range of the device's sensors. Figures 6a and 7a show frequency sensitivity of both sensing elements and their phase response. For the electric field, the upper frequency of 47 kHz was obtained, and for the magnetic receiver, it equaled 48 kHz. The sensitivity regularities observed in the operating band are below 1 dB. Out of band amplitude characteristics show the slope of -12 dB/octave, which corresponds to the double-pole transmittance type.

Figures 6b and 7b show phase characteristics of the sensing system. Both exceed the 3 dB frequency limit at the phase of -180° , which is a typical response for a double pole transmittance system [14].

3.2. Tests under Real Mining Conditions

The designed unit was installed in a real, operable hard coal mine. The receiver was placed in a borehole made in an inactive wall, where it was taking autonomous measurements over a period of 10 days.

To achieve reliable results, first the natural EM background disturbances present at the location in question were de-

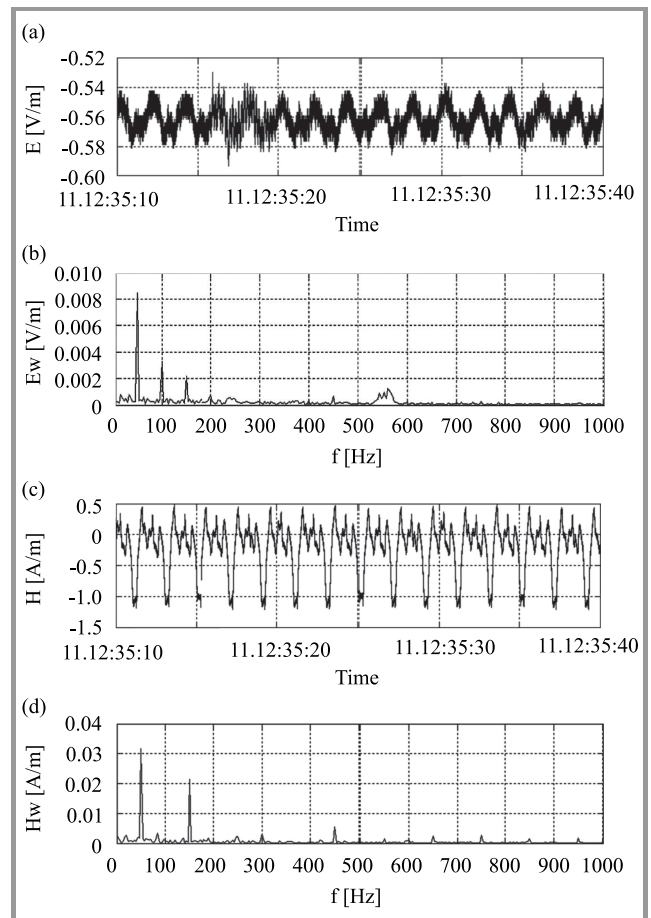

Fig. 8. EM background in an inactive mine for: (a) electric component, (b) E component spectrum, (c) H component, (d) H component spectrum.

terminated. The time waveforms obtained are periodical in nature and their peak-to-peak values are relatively low (Fig. 8a–c).

Spectral analysis shows that the majority of interferences originate from the power mains (with spectrum peaks visible at 50, 100 and 150 Hz).

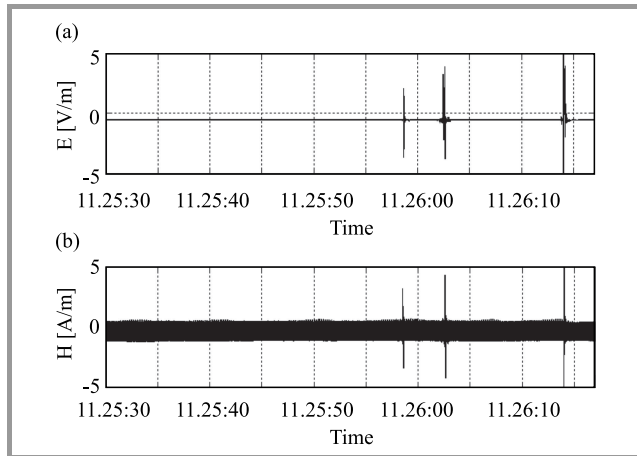

Fig. 9. Received series of EM pulses exceeding the background level registered at the measurement location.

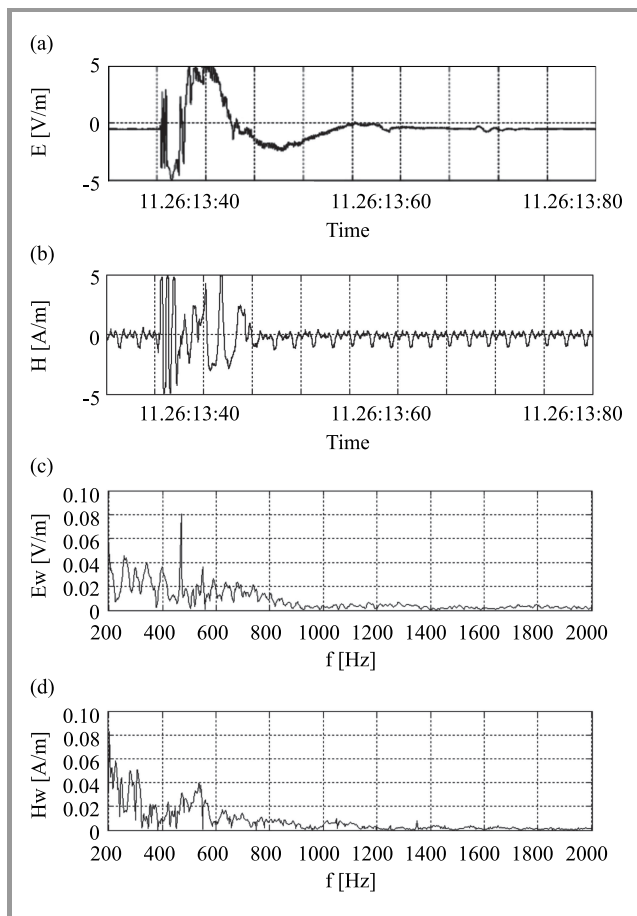

Fig. 10. Detailed analysis of recorded signal presented in Fig. 9: (a) E component, (b) H component, (c) E signal frequency spectrum, (d) H signal spectra.

During the 10-day test conducted under real mine conditions, at least several events of increased spontaneous electromagnetic emissions were recorded. They had the form of a series of pulses with different amplitudes and short repetition times. Since the receiver was installed in an inactive mine, the disturbances from equipment working at the mine could be excluded. Figure 9 shows an example of events related to a low-energy mine collapse. The results shown are representative of the entire set of EM events recorded during the test and of other seismic events that occurred in the mine.

Figure 10 presents an analysis of the series of recorded EM pulses from Fig. 9. The fading waveform is visible there (Fig. 10a–b) lasting up to 200 ms and up to 100 ms for the E component and for the H component, respectively. After performing the Fourier transformation (Fig. 10c–d), it was determined that a significant portion of the frequency response is within the 1 kHz band.

4. Conclusions

The use of an integrated, autonomous EM receiver in a real mine allows for early detection of upcoming seismic events. During its operation in the mine, the receiver recorded several such events. A single event of this type is characterized by a series of pulses with short repetition intervals. The period of the recorded pulses depends on the dynamics of the seismic process. Low-energy seismic events were recorded during mining. Interference from the power mains adversely affected the quality of the recorded data. However, with proper shielding of the receiver’s sensing device, it is possible to significantly reduce the interference level. In addition, the digitized signal obtained should be processed to lower the impact of noise.

The frequency band of the recorded seismic pulses increases up to several kilohertz. This was also confirmed during laboratory tests performed as part of the research project.

Measurements of EM emissions generated by force-stressed rocks may be used as an additional warning factor. Currently, the seismic method is relied upon in mines for this particular purpose. However, new detection methods are being developed constantly and may offer a valuable addition to the classic approach. Fortunately, it is possible to create an early warning system for identifying mine collapse hazards by using a network of EM field receivers distributed throughout the mine and installed at the locations that are most sensitive, from the geological point of view.

References

[1] M. Akgün, “Coal mine accidents”, *Turkish Thoracic J.*, vol. 16, no. S1–S2, 2015 (DOI: 10.5152/ttd.2015.008).

[2] J. L. X. Meng, Y. Wang, and Z. Yang, “Prediction of coal seam details and mining safety using multicomponent seismic data: A case history from China”, *Geophysics*, vol. 81, no. 5, pp. B149–B165, 2016 (DOI: 10.1190/geo2016-0009.1).

- [3] A. Pralat, K. Maniak, and I. Pompura, "Electromagnetic phenomena in landslides", *Acta Geodynamica and Geomaterialia*, vol. 2, no. 3, pp. 131–138, 2005 [Online]. Available: https://www.irsm.cas.cz/materialy/acta_content/2005_03/16_Pralat.pdf
- [4] V. Frid, "Calculation of electromagnetic radiation criterion of rock-burst hazard forecast in coal mines", *Pure and Applied Geophysics*, vol. 158, pp. 931–944, 2001 (DOI: 10.1007/PL00001214).
- [5] V. Frid and K. Vozoff, "Electromagnetic radiation induced by mining rock failure", *Int. J. of Coal Geology*, vol. 64, no. 1–2, pp. 57–65, 2005 (DOI: 10.1016/j.coal.2005.03.005).
- [6] D. Lin-ming, L. Cai-ping, M. Zong-long, and G. Ming-shi, "Prevention and forecasting of rock burst hazards in coal mines", *Mining Sci. and Technol. (China)*, vol. 19, no. 5, pp. 585–591, 2009 (DOI: 10.1016/S1674-5264(09)60109-5).
- [7] L. Guang-Jian, Lu Cai-Ping, W. Hong-Yu, L. Peng-Fei, and Liu Yang, "Warning method of coal bursting failure danger by electromagnetic radiation", *Shock and Vibration*, vol. 2015, 2015 (DOI: 10.1155/2015/583862).
- [8] E. Wang, H. Jia, D. Song, N. Li, and W. Qian, "Use of ultra-low-frequency electromagnetic emission to monitor stress and failure in coal mines", *Int. J. of Rock Mechanics & Mining Sciences*, vol. 70, pp. 16–25, 2014 (DOI: 10.1016/j.ijrmms.2014.02.004).
- [9] Z. Shijiea, S. Xiaoyuanc, L. Chengwub, X. Xiaoxuan, and X Zhuang, "The analysis of coal or rock electromagnetic radiation (EMR) signals based on Hilbert-Huang transform (HHT)", in *Procedia Engin.*, vol. 26, pp. 689–698, 2011 (DOI: 10.1016/j.proeng.2011.11.2224).
- [10] R. Mydlikowski and K. Maniak, "Measurement of electromagnetic field component emission as a precursor of emerging hazard in coal mines", *J. of Telecommun. and Inf. Technol.*, no. 4, pp. 30–35, 2019 (DOI: 10.26636/jtit.2019.135419).
- [11] Z. Loni, H. Espinosa, and D. Thiel, "Insulated wire fed floating monopole antenna for coastal monitoring", *Radioengineering*, vol. 27, no. 1, pp. 127–133, 2018 (DOI: 10.13164/re.2018.0127).
- [12] V. Dyo, T. Ajmal, B. Allen, D. Jazani, and I. Ivanov, "Design of a ferrite rod antenna for harvesting energy from medium wave broadcast signals", *The J. of Engin.*, vol. 2013, no. 12, pp. 89–96, 2013 (DOI: 10.1049/joe.2013.0126).
- [13] T. Bolton and M. B. Cohen, "Optimal design of electrically-small loop receiving antenna", *Progress In Electromagnetics Research C*, vol. 98, pp. 155–169, 2020 (DOI: 10.2528/PIERC19090911).
- [14] U. Tietze, Ch. Schenk, and E. Gamm, *Electronic Circuits—Handbook for Design and Application 2nd Edition*. Springer, 2011 (ISBN-13: 9783540004295).

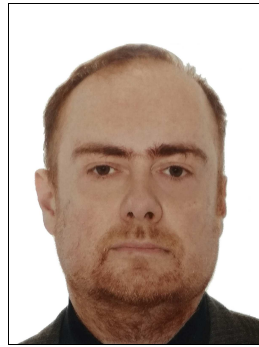

Krzysztof Maniak received his M.Sc. and Ph.D. degrees in Electronics from Wrocław University of Technology, Poland, in 2001 and 2008, respectively. Since 2012, he has been with the National Institute of Telecommunications in Wrocław. He is an author and co-author of numerous research papers and publications. His professional work focuses on: power systems, electromagnetic compatibility and design of measuring equipment. He also participates in research and measurement-related activities. His research interests focus on the testing of power grid quality and its broadband interference protection.

His professional work focuses on: power systems, electromagnetic compatibility and design of measuring equipment. He also participates in research and measurement-related activities. His research interests focus on the testing of power grid quality and its broadband interference protection.

 <https://orcid.org/0000-0003-1974-909X>

E-mail: k.maniak@itl.waw.pl

National Institute of Telecommunications

Swojczycka 38

51-501 Wrocław, Poland



Remigiusz Mydlikowski received his M.Sc. and Ph.D. degrees in Electrical Engineering from Wrocław University of Science and Technology, Wrocław, Poland, in 1997 and 2002, respectively. He is currently with the Department of Theory of Field Theory, Electronic Systems and Optoelectronics at Wrocław University of Science and Technology. His research interests are in non-invasive studies of ground and rock properties.

 <https://orcid.org/0000-0002-8670-2913>

E-mail: remigiusz.mydlikowski@pwr.edu.pl

Wrocław University of Science and Technology

Wybrzeże Wyspiańskiego 27

50-370 Wrocław, Poland