

end of life vehicles; ELV; reuse of components;  
dismantling of vehicles; recycling

**Piotr NOWAKOWSKI**

Silesian University of Technology, Faculty of Transport,  
Department of Logistics and Mechanical Handling  
Kraśińskiego 8, 40-019 Katowice, Poland  
*Corresponding author.* E-mail: [piotr.nowakowski@polsl.pl](mailto:piotr.nowakowski@polsl.pl)

## **REUSE OF AUTOMOTIVE COMPONENTS FROM DISMANTLED END OF LIFE VEHICLES**

**Summary.** The problem of recycling end of life automotive vehicles is serious worldwide. It is one of the most important streams of waste in developed countries. It has big importance as recycling potential of raw materials content in automotive vehicles is valuable. Different parts and assemblies after dismantling can also be reused in vehicles where replacement of specific component is necessary. Reuse of the components should be taken into consideration in selecting the vehicles dismantling strategy. It also complies with European Union policy concerning end of life vehicles (ELV). In the paper it is presented systematic approach to dismantling strategies including disassembly oriented on further reuse of components. It is focused on decision making and possible benefits calculation from economic and environmental point of view.

## **PONOWNE UŻYCIE CZĘŚCI SAMOCHODOWYCH ZDEMONTOWANYCH Z POJAZDÓW WYCOFANYCH Z EKSPLOATACJI**

**Streszczenie.** Problematyka zagospodarowania odpadów powstających z wyeksploatowanych pojazdów samochodowych stanowi wyzwanie dla państw Europejskich i innych części świata. Potencjał surowcowy pojazdów jest znaczny, jednakże różne komponenty mogą zostać wykorzystane ponownie. Występuje to w sytuacji, gdy pojawi się konieczność wymiany części w pojeździe i może ona zostać zastąpiona przez część używaną pozyskaną w wyniku demontażu. Taka możliwość powinno się uwzględnić w wypadku wyboru strategii demontażowych. Takie podejście jest zgodne z zaleceniami i polityką UE dotyczącą wyeksploatowanych pojazdów. W pracy przedstawiono podejście systemowe przy zorientowaniu procesu demontażu pojazdów na ponowne użycie części. Uwzględniono w nim proces decyzyjny wraz z aspektami ekonomicznymi i dotyczącymi oceny aspektów środowiskowych.

### **1. INTRODUCTION**

Within the last 25 years the number of cars increased significantly. European Union average motorization rate has increased from 330 vehicles per 1000 inhabitants in 1990 to over 470 in 2008. In the fig. 1 it is presented a change of motorization rate in selected European countries [14].

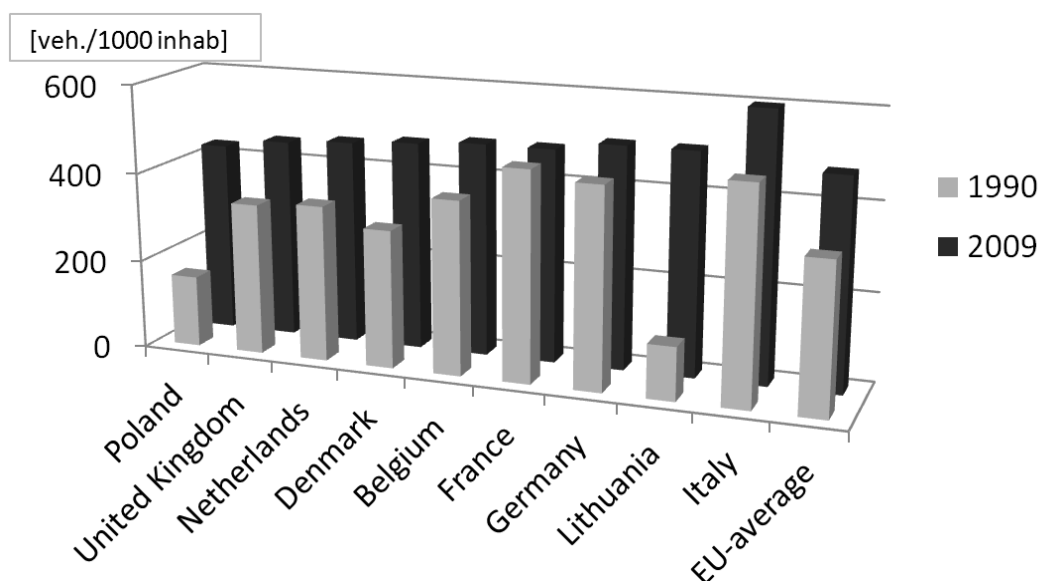

Fig. 1. Motorization rate in 1990 and 2008 in selected countries of European Union

Rys. 1. Wskaźnik motoryzacji w 1990 r. i 2008 r. w wybranych krajach Unii Europejskiej

Usually the operation time for automotive vehicle does not exceed 15-20 years [6,10]. After that time the vehicles are supposed to be dismantled and recycled. As the motorization rate is growing it implies increasing the number of end of life vehicles (ELV). There are different problems occurring with collection, dismantling and recycling ELV. They are the source of raw materials like ferrous and non-ferrous metals, glass, plastics and rubber. Other components used in automotive vehicles construction are dangerous for human health and natural environment. They can be classified as liquid substances – petrol, oil, hydraulic liquids, and cooling agents. There are also lead and other batteries applied as well as the electronic equipment: like control panels, on-board computer, sensors etc. The environmental concern in handling these substances was one of the reasons to introduce European Directive [12]. There is described the entire system for design, operation, dismantling and recycling of automotive vehicles. It includes guidelines for companies designing parts and components and dismantling plants. Entire framework is oriented to reduce environmental impact of ELV and to maximize recycling ratio of materials used in vehicles.

## 2. NUMBER OF ELV IN EUROPEAN UNION AND AVERAGE RAW MATERIALS COMPOSITION OF A VEHICLE

The number of ELV in European Union reached 7,5 million vehicles in 2010 [13]. In the figure 2 there are shown the numbers of ELV for countries in EU (data for 2010). It is a challenging task to create reverse logistics chain. In developed countries the system is effective. All processes comply with standard described in ELV directive. The number of ELV vehicles corresponds to 7,3 million tons of raw materials. The materials of main components in automotive vehicles are metals. The average of ferrous metals used in vehicle's construction is about 70% and non ferrous about 7%. Other components materials are plastics (PE, PP, PA) – 10% of total mass of an average vehicle. The rest components' materials are rubber (4,5%), glass (2,6%), liquids (2,4%) and other, including textiles and other interior parts [7].

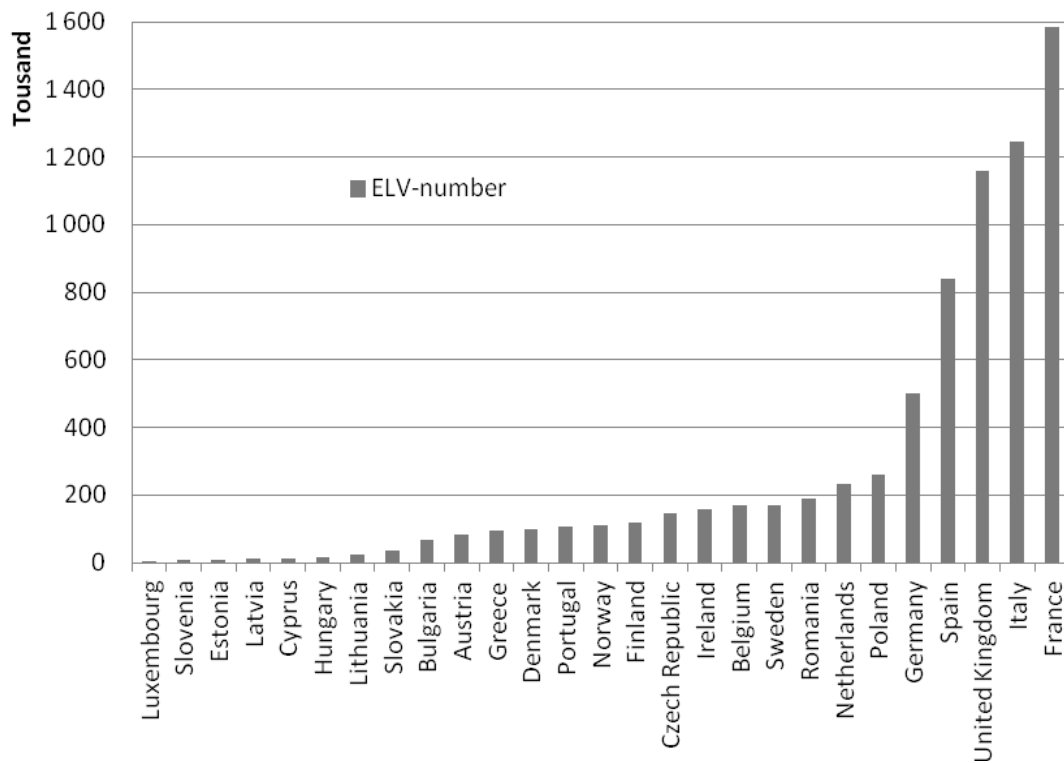

Fig. 2. Number of ELV in European Union in 2010

Rys. 2. Liczba pojazdów samochodowych wycofanych z eksploatacji w Unii Europejskiej w 2010 r.

The average materials composition for mid-size vehicle is shown in the fig. 3.

There are numerous companies involved in reverse logistics chain including recycling plants, iron works, non-ferrous metals works, plastics and rubber recycling works, hazardous substances neutralizing and incineration plants [8]. Finally after shredding the wrecks, the residues (ASR) may be transported to landfills although it is not a preferred method of disposal [4].

For raw materials acquisition oriented dismantling there are different tasks involved with handling and transportation to recycling plants.

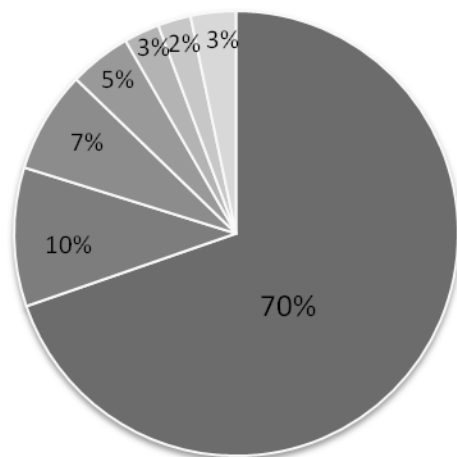

Material	Mass [kg/veh.]	[%]
Ferrous metals	697	70
Plastics	101	10
Non-ferrous metals	74	7
Rubber	45	5
Glass	26	3
Liquids	24	2
Other	33	3

Fig. 3. The average composition of materials for mid-sized vehicle (Opel Astra)

Rys. 3. Średni skład materiałowy pojazdu samochodowego średniej wielkości (Opel Astra)

### 3. DISMANTLING METHODS OF ELV

There are different types of dismantling vehicles. They usually depend on infrastructure of the station and selected strategy. Number of the vehicles that can be dismantled depends on input volume and efficiency of the station. For all types of dismantling there are specific steps to be undertaken. They must comply with ELV directive. There are two main approaches to vehicles disassembly: continuous – industrial type and stationary – for medium and small plants. For continuous type the flow of the vehicles are similar to assembly line of automotive industry but in reverse direction. Usually it is divided into several sections where typical operations are executed [2].

First step is the depolution of the vehicle. General view of dismantling procedures is shown in the figure 4. It is usually done by removing all liquids, explosive materials (airbags) and materials including hazardous substances.

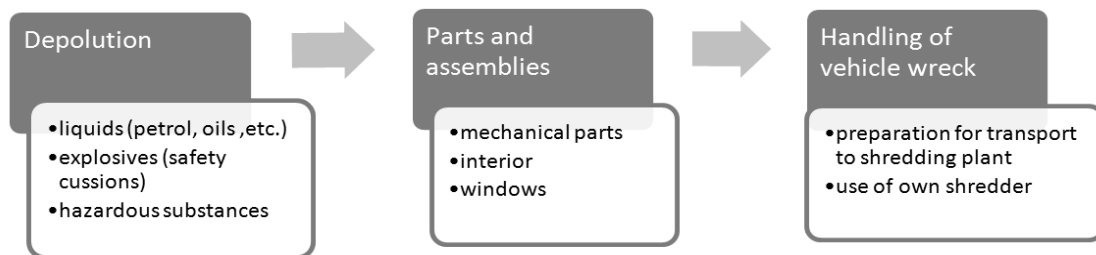

Fig. 4. General approach to dismantling of vehicles

Rys. 4. Ogólny schemat demontażu pojazdów

Then there are removed other parts like windshields and windows, mechanical parts from engine compartment, interior components, tires and other parts. It is available useful software – International Dismantling Information System (IDIS) dedicated for dismantling stations supported of consortium of majority of automotive vehicles manufactures in the world. They support data exchange between designers and producers and dismantling plants with special platform where the methodology of disassembling and tools are visualized to make the whole process easier (fig. 5) [15].

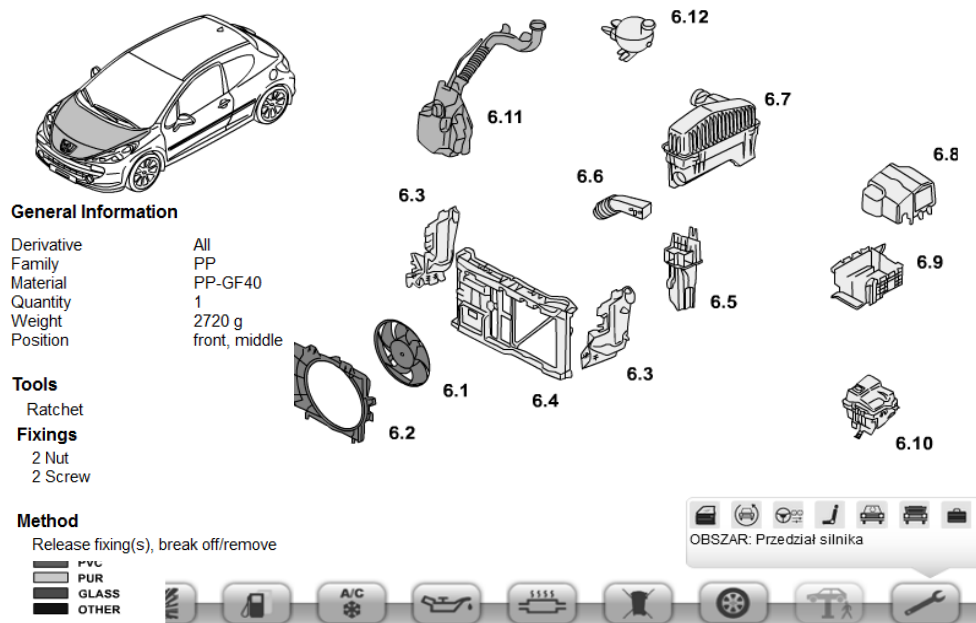

Fig. 5. View of IDIS disassembly visualization tool

Rys. 5. Widok systemu wizualizacji demontażu IDIS

#### 4. REUSE OF COMPONENTS AFTER DISMANTLING

After depolution it is possible to select proper method of dismantling (fig. 6). Depending on vehicle model the dismantling procedure can be focused on raw materials only, removal of parts with high market demand and parts with probability to be sold on the market [3].

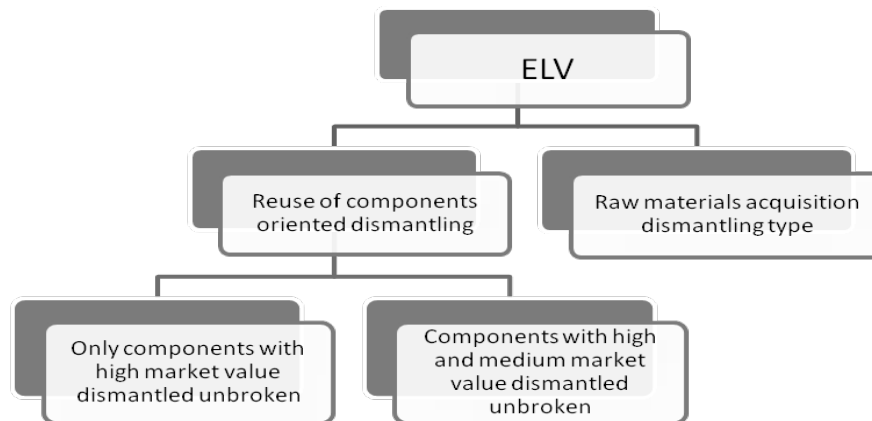

Fig. 6. Strategy selection in ELV dismantling  
Rys. 6. Wybór strategii demontażu SWE

For the reuse of components oriented dismantling, the suitable parts depend on current number of the vehicles equipped with specific part (when the part is broken or faulty) and forced to replace it. It is connected with the number of vehicles in population equipped with certain type of a part or assembly. If the population is big enough it may be rational to provide longer and more detailed type of disassembly. It should be also remembered that in case of bigger population it can be substitute parts available on the market with lower price than original ones. This is the most important competitor between parts to be reused and new replacement parts.

There are two main benefits of reuse the components of automotive vehicles. One is focused on economic aspects and the other towards environment protection. Both benefits comply with European policy on recycling of ELV [5].

Dismantling of vehicle oriented to maximize the number of parts and assemblies for possible futher use requires special tools and equipment together with skilled workers to disassemble each mechanism or unit. Some components need to be removed with special care to maintain the market value to be able to be sold on the market. It concerns different joints, connectors or plugs.

Direct profit is connected with selling the component on the market after subtracting the costs.

It can be calculated from the following formulae:

$$c_t = \sum_{i=1}^7 c_i \quad (1)$$

where:  $c_t$  – total cost of component to be reused, costs:  $c_1$  – dismantling,  $c_2$  – verification,  $c_3$  – repair,  $c_4$  – storage,  $c_5$  – shipment,  $c_6$  – assembling,  $c_7$  – logistics chain and service (identification, package, human resources)

The profit  $p_r$  – of selling the part to be reused must fulfill conditon (2):

$$p_r > c_t \quad (2)$$

The algorithm of dismantling procedures and processes is shown in the figure 7. It is necessary to take into consideration the cost of individual operation and benefits after a part is ready for reuse. In many cases only visual inspection of a component is required. It applies to different parts of vehicle body like doors, trunk, hood, grill or bumpers. For other parts it is necessary to pass special tests. Usually, it is possible only on special laboratory analysers or expensive devices. It applies to gearboxes, engines, injection, electric components and motors. Other valuable assemblies belong to electronics group – in this case very detailed test are necessary with advanced software. If the parts are faulty, broken or impossible to remove in good condition they can be treated as raw materials. Each process incurs costs which were described in formula (1). For management of parts and assemblies there are some websites and information systems developed like Ares [9]. It is included possibility of application of ID-systems, storage tasks, reports and web-site based interface for customer and vehicle service stations [16].

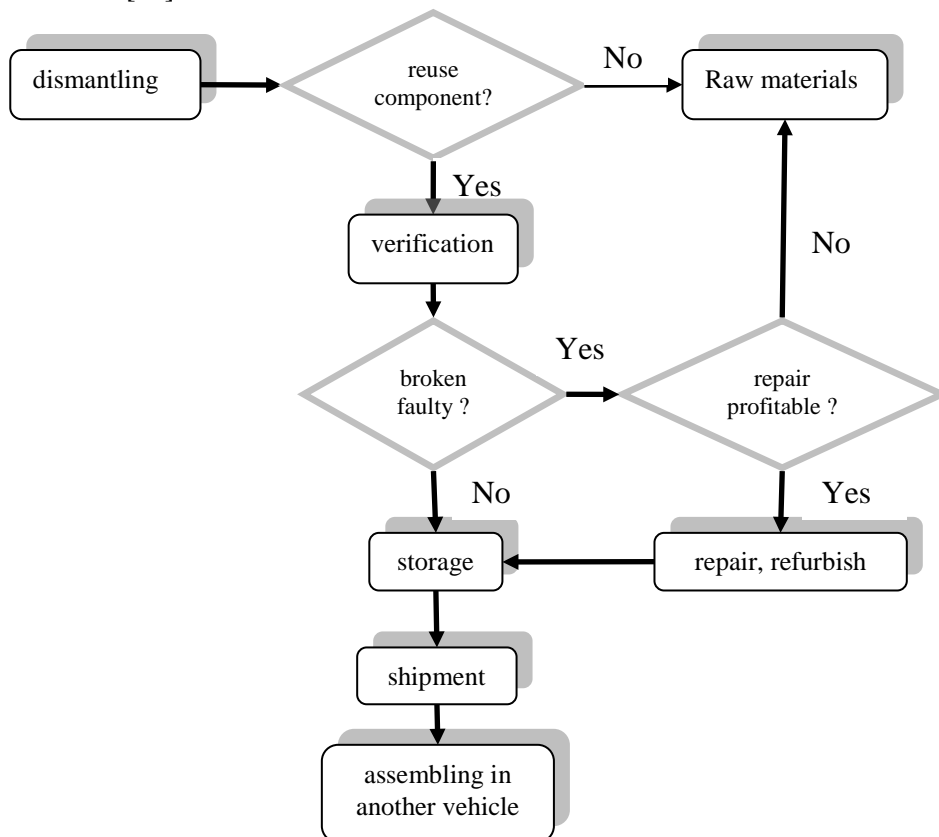

Fig. 7. Algorithm for reuse oriented dismantling

Rys. 7. Algorytm demontażu zorientowany na ponowne użycie części

In the described approach only the economic aspect is taken into consideration. In case of natural environment impacts it is necessary to include in calculations the benefits of continuous use of component for extended period of time and saving natural resources for a new component to be applied. Direct cost analysis is difficult to be undertaken but it is possible to use LCA life cycle assessment for evaluation of environmental benefits of reusing parts and assemblies of ELV. Detailed description of the analysis is included in ISO standard family 14040 [11]. For the analysis it is required material content of an assembly, manufacturing process data, energy consumption in all life cycle stages and transportation process data. Also it is required to input: expected life time and end of life designation (fig. 8).

Detailed analysis can be made in advanced LCA software [17]. Simplified methods are available in CAD software (eg. SolidWorks) and are useful at design stage. The results show four main environmental impacts (carbon footprint, energy used, acidification of air and eutrophication of water) [1].

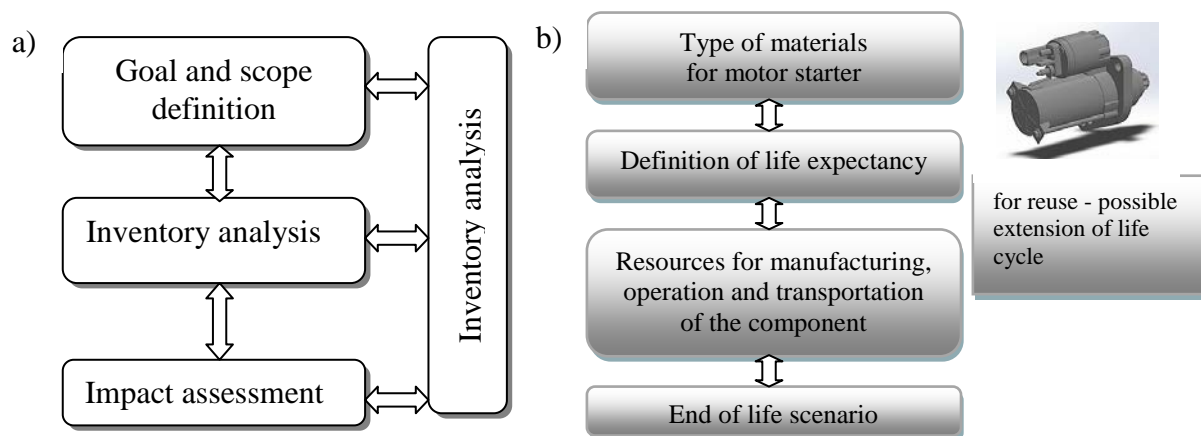

Fig. 8. General life cycle assesment structure (a) and details of inputs of analysis for motor starter (b)  
Rys. 8. Ogólny schemat analizy LCA (a) i przykład danych wejściowych dla rozrusznika (b)

In the figure 9 there are presented results for motor starter manufactured in Europe and for expected life 15 years. It can be compared to alternative rersults for longer life cycle.

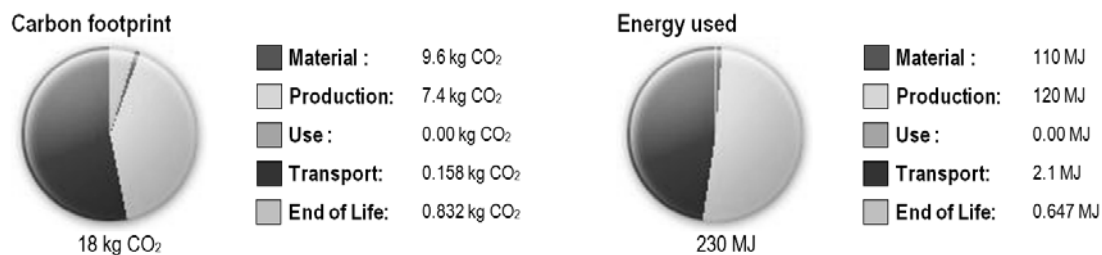

Fig. 9. Main environmental impacts of life cycle of the motor starter (carbon footprint and energy used)  
Rys. 9. Główne oddziaływania na środowisko dla cyklu życia rozrusznika (CF i zużycie energii)

## 5. CASE STUDY OF REUSE THREE TYPES OF AUTOMOTIVE VEHICLES COMPONENTS

For the case study of components to be reused it will be presented 3 parts (assemblies) from automotive vehicle (Volkswagen Passat): bonnet, wiper assembly, and motor starter.

Each type requires different operations to be dismantled from vehicle: manual disassembly, visual inspection, visual inspection, operation tests, storage, handling, on-site transportation and shipment to customer. The results are presented in the table 1. The easiest for dismantle and to verify is bonnet. More difficult is handling and shipment. Preferably that kind of component should not be transported between multiple places due to the cost. Wiper assembly requires operational tests and general dimensions allow for easier handling and storage. Motor starter requires electric tests and usually some improvements by parts exchange. Preferably it should be done at the manufacturer or well equipped refurbishment plant. For that type of components it is necessary to prepare logistic chain for a group of regional dismantling stations. Individual analysis of profitability of dismantling individual component should include all costs indicated in formula (1) and market demand analyse for that part. For environmental impact analysis detailed results can be obtained from advanced LCA software systems and in simplified form as shown in previous chapter of this paper.

Table 1

Main parameters of end of life processes for 3 selected components of VW Passat

Part (assembly) name	Dismantling difficulty	Verification of part	Handling and shipment	Cost of: [PLN]			Environmental issue
				used part	substitute part	new part	
bonnet	easy	visual inspection	difficult	250	400	650	low
wiper assem.	medium	operation tests	easy	80	170	320	low
motor starter	medium	electric tests	medium	150	320	550	medium

## 6. CONCLUSIONS

Dismantling of end of life vehicles can be focused on reuse of components. It is one of the strategies of European Policy included in ELV directive. Reuse of components is profitable when the market demand is met and external costs including dismantling, verification, tests, labour, storage and handling do not exceed profit of selling used part on the market. Verification of some parts is expensive due to the cost of laboratory tests and analysis. For such components it should be created network of dismantling plants and central collecting and testing station equipped with proper instruments and devices for component verification.

Other benefit of reuse the automotive vehicles components is oriented towards natural environment. Although the value can not be calculated directly as economic profit but it can be used life cycle assesment method to evaluate extended life of a product. It can be used at the designing stage in simplified form computer aided design software or advanced LCA analysis systems to obtain more detailed results.

## Bibliography

1. Kowalski, Z. & Kulczycka, J. & Góralczyk, M. *Ekologiczna ocena cyklu życia procesów wytwórczych (LCA)*. Warszawa: PWN. 2007. [In Polish: Kowalski, Z. & Kulczycka, J. & Góralczyk, M. *Environmental assessment of life cycle of manufacturing processes (LCA)*. Warsaw: PWN]
2. Osiński, J. & Żach, P. *Wybrane zagadnienia recyklingu samochodów*. Warszawa: WKiŁ. 2006. [In Polish: Osinski, J. & Zach, P. *Selected issues of cars recycling*. Warsaw: WKiŁ]
3. Coate, G. & Rahimifard, S. Assessing the economics of pre-fragmentation material recovery within the UK. *Resources, Conservation and Recycling*. 2007. Vol. 52. P. 286-302.
4. Forton, O.T. & Hardera, M.K. & Moles, N.R. Value from shredder waste: Ongoing limitations in the UK. *Resources, Conservation and Recycling*. 2006. Vol. 46. P. 104-113.
5. Mazzanti, T. & Zoboli, R. Economic instruments and induced innovation: The European policies on end-of-life vehicles. *Ecological Economics*. 2006. Vol. 58. P. 318-337.
6. Nader, M. & Jakowlewa, I. Wybrane zagadnienia organizacji zakładu recyklingu samochodów osobowych. *Prace Naukowe Politechniki Warszawskiej, Transport*. 2009. Vol. 70. P. 127-138. [In Polish: Nader, M. & Jakowlewa, I. Selected issues of management in recycling vehicles plant. *Scientific Papers of Warsaw University of Technology, Transport*. 2009. Vol. 70. P. 127-138].
7. Nowakowski, P. Dismantling of end life vehicles in Poland. *Transport Problems*. 2008. Vol. 3. No. 3. P. 17-24.
8. Nowakowski, P. Logistics system of collection, dismantling and recycling of end-of-life vehicles. *Transport Problems*. 2010. Vol. 5. No. 4. P. 81-86.
9. Małyżko, A. & Izdebki, J. System ARES jako propozycja uzyskania najwyższej efektywności działania stacji demontażu w Polsce. *II Międzynarodowa Konferencja Naukowo-Techniczna „Problemy recyklingu”*. Rogowo. 2002. [In Polish: Małyżko, A. & Izdebki, J. ARES system –



- proposal to increase effectiveness of dismantling station in Poland. *Proceedings II International Conference „Recycling Problems”*. Rogowo. 2002].
10. “D6: Car Shredding Manuals”. EES, Public Report from SEES Project, Sustainable Electrical and electronic systems for the automotive sector Contract N°: TST3-CT-2003-506075” 2006.
  11. ISO 14040 (2006): *Environmental management – Life cycle assessment – Principles and framework*. International Organisation for Standardisation (ISO). Geneve. 2006.
  12. Directive 2000/53/EC of the European Parliament and of the Council of 18 September 2000 *on end-of life vehicles*.
  13. *End of Life Vehicles (ELVs)*. Available at: [http://epp.eurostat.ec.europa.eu/portal/page/portal/waste/key\\_waste\\_streams/end\\_of\\_life\\_vehicles\\_elvs](http://epp.eurostat.ec.europa.eu/portal/page/portal/waste/key_waste_streams/end_of_life_vehicles_elvs)
  14. *Energy, transport and environment indicators*. Eurostat pocketbooks. 2009. Available at: [http://epp.eurostat.ec.europa.eu/cache/ITY\\_OFFPUB/KS-DK-09-001/EN/KS-DK-09-001-EN.PDF](http://epp.eurostat.ec.europa.eu/cache/ITY_OFFPUB/KS-DK-09-001/EN/KS-DK-09-001-EN.PDF)
  15. *IDISonlinedata*. Available at: <http://onlinedata.idis2.com/index.php>.
  16. *AMBIT Spółka z o.o.* Available at: <http://www.ambit.pl/>
  17. *LCA Links*. Available at: [http://www.life-cycle.org/?page\\_id=125](http://www.life-cycle.org/?page_id=125)

Received 13.07.2012; accepted in revised form 05.11.2013