

Utilization of the SOA Deep Saturation and Power Averaging Effect to Counteract Intra-Channel Crosstalk in DWDM System

Fryderyk M. Dyc, Paweł Mazurek, and Jarosław P. Turkiewicz

Faculty of Electronics and Information Technology, Warsaw University of Technology, Warsaw, Poland

Abstract—The Semiconductor Optical Amplifier (SOA) is a key component of cost-effective short/medium range transmission systems. However it can introduce signal distortions. In this paper the authors investigate the possibility to reduce the signal distortions in SOA operating with the multiple wavelength channels. Using numerical simulations the negative influence of the nonlinear effects, namely cross-gain modulation (XGM) and the patterning effect can be reduced in deep SOA saturation regime. The self-healing effect is pronounced for the 4 or more wavelength channels and the transmitted symbol length longer than double of the SOA recovery time.

Keywords—cross gain modulation, Dense Wavelength Division Multiplexing, Semiconductor Optical Amplifier.

1. Introduction

The increasing demand for the short and medium range high capacity optical transmission systems, utilized in, e.g., Local Area Networks (LAN), Metropolitan Area Networks (MAN), and data/storage center interconnections, has recently caused the growth of interest in Semiconductor Optical Amplifiers (SOAs). Main advantages of SOA are: low cost, possibility of the photonic integration with other components like lasers or modulators, relatively high gain, and wide amplification bandwidth. On the other hand, the main SOA disadvantages are high noise figure (6 dB or more) and introduction of the nonlinear effects like the inter-channel crosstalk caused by the cross gain modulation (XGM) effect. XGM is caused by the decrease of the carrier density in the active region of the SOA. Moreover, the SOA carrier recovery time (t_c) in the range of 10 to 200 ps causes patterning effect for the signal with the symbol bit rate over 1 Gb/s [1], [2]. Those two effect contribute to the intra-channel crosstalk in the Dense Wavelength Division Multiplexed (DWDM) systems. Therefore techniques are needed to counteract signal distortions in the SOA.

So far, the following techniques have been used to mitigate the SOA XGM and the patterning effect: utilization of the gain-clamped SOA [3], keeping the SOA in the shallow saturation state [4], utilization of the continuous wavelength reservoir channel to suppress the power fluctuations in the SOA [5], introduction of the additional dummy signal with

inverted polarization to achieve the constant intensity of the output signal [6], dispersion management [7], modulation of the SOA injection current in accordance with the transmitting bit sequence [8], feeding the SOA with many channels to achieve the power averaging effect while keeping the SOA in the shallow saturation state [9], utilization of the constant envelope modulation format [10], utilization of the optical equalizers at the output of the amplifier [11], [12] or active control of the decision threshold in the receiver [13]. The abovementioned methods of counteracting the nonlinear effects have following drawbacks: high power penalty [5], [6], poor utilization of the available SOA output power level [4], [9], high system complexity [7], [8], [10], [12] or the necessity to replace the currently installed equipment [3].

In the article, the authors analyze the possibility to counteract negative influence of XGM and patterning effect, by driving the SOA into deep saturation. The proposed method allows the mitigation of the negative SOA on the signal quality influence, while avoiding disadvantages of the mentioned methods. In particular, the impact of the DWDM channel number, signal line rate, signal extinction ratio and the depth of the SOA saturation on the amplified signal quality is investigated. The conducted simulations show that reduction of the signal distortions and smallest power penalty introduced by the SOA occur for the number of channels 4 or more and for the line rates, for which the ratio of the carrier recovery time to symbol duration (t_c/T_b) is greater or equal 2. For a typical SOA, for which the carrier recovery time is 250 ps [14], this corresponds to the bit rate over 8 Gb/s. The signals with high extinction ratio show overall better signal quality. The method proposed in the article can be successfully utilized to increase the performance of, e.g., the cost-effective 400G and 1000G Ethernet systems.

2. Semiconductor Optical Amplifier

A Semiconductor Optical Amplifier is an optoelectronic device capable of amplifying the optical signal. Its structure is similar to a semiconductor laser. The amplification takes place in the active region of the amplifier after obtaining

the carrier population inversion. In the SOA amplifier, the increase of the optical output power leads to the decrease of the carrier density (or carrier number), which in turn leads to the decrease of the gain (saturation effect). The SOA gain recovery time varies from 10 to 200 ps, therefore the signal amplification depends on the previous signal levels. Impact of the saturation effect and the amplifier's memory (patterning effect) on the transmitted signal was studied in [1], [13].

The operation of the amplifier can be modeled with the following rate equations [2]:

$$n(z, t + \Delta t) = n(z, t) + \left\{ \frac{I}{eV} - \frac{n(z, t)}{\tau_c} - \frac{a_1 [n(z, t) - n_0] I_{\text{sig}}(z, t)}{h\nu} \right\} \Delta t, \quad (1)$$

$$I_{\text{sig}}(z, t + \Delta t) = I_{\text{sig, in}}(z, t + \Delta t) \exp \left\{ \int_0^z a_1 [n(z, t + \Delta t) - n_0] dz' \right\}, \quad (2)$$

$$I_{\text{sig, in}}(t) = \frac{\Gamma P_{\text{in}}(t)}{A}, \quad (3)$$

$$A = d \cdot W, \quad (4)$$

where n is the carrier density in the SOA active region, t is the time, z is a distance from the beginning of the SOA active region, I is the injection current, e is the elementary charge, V is the volume of the SOA active region, τ_c is the carrier life time, a_1 is the differential gain factor, n_0 is the carrier density in the SOA transparency point (state when the losses within the SOA are compensated by the SOA gain), I_{sig} is the optical signal intensity, h is the Planck's constant, ν is the frequency of the optical signal, Γ is the optical confinement factor, P_{in} is the instantaneous input optical power, A is the cross-section area of the SOA active region, d is the height of the SOA active region, W is the width of the SOA active region, and L is the length of the SOA active region. The utilized model does not take into account the wavelength dependency of the gain profile. The presented above SOA model takes into

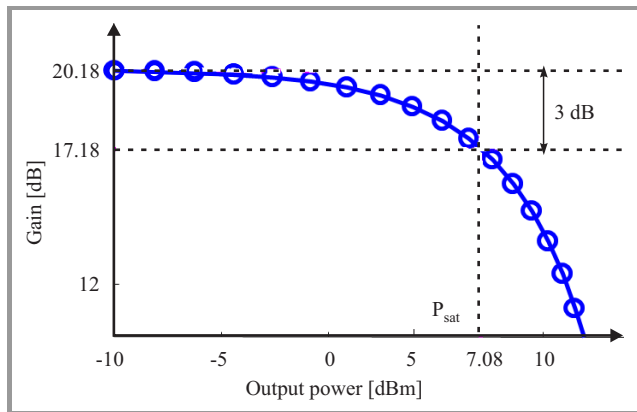

Fig. 1. The SOA gain in the function of the output power.

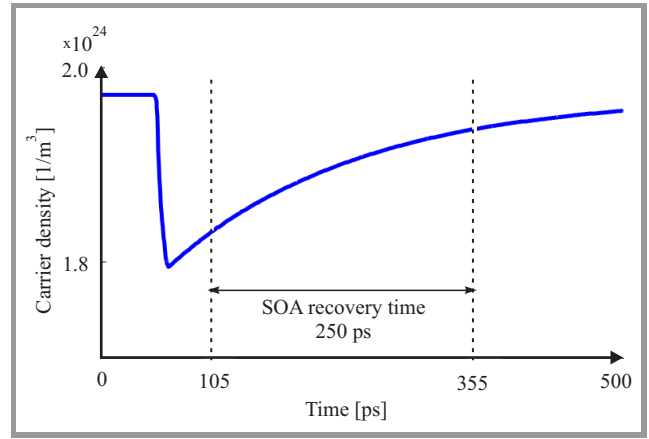

Fig. 2. The SOA carrier density in the function of time after single impulse amplification.

account the saturation effect, the XGM effect and the carrier recovery time.

The applied in simulations SOA amplifier had the nominal small signal gain G of 20.18 dB and saturation output power P_{sat} of 7.07 dBm (Fig. 1). The carrier recovery time t_c measured with 20%-80% method was equal to 250 ps (Fig. 2).

3. Numerical Simulations

3.1. Simulation Setup Block Diagram

The block diagram of the simulation setup is shown in Fig. 3. The SOA amplifier is fed with the multi-wavelength signals characterized by the extinction ratio ER , line rate B ,

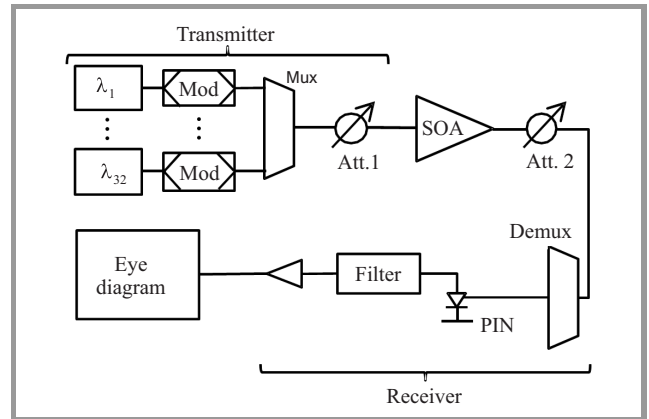

Fig. 3. The simulation setup.

number of channels Ch , and input optical power per channel P_{in} . The utilized pseudo-random bit sequence had the length of $2^{15} - 1$. The bit sequences and the initial phases of the DWDM signals were random for each channel, which resulted in the signal decorrelation. The number of OOK modulated channels Ch was changed from 1 to 32 and the extinction ratio ER had values of 10 dB and 30 dB, which corresponds to the typical values of two major types of the

optical modulators: the electro-absorption modulators and the Mach-Zehnder modulators, respectively. The utilized wavelength multiplexer and demultiplexer were ideal without any losses and intra-channel crosstalk. In the receiver, only the thermal noise was taken into account and its level was independent of the signal power [16]. The electrical filter used in the receiver was the 5th order Bessel filter. Moreover, in the receiver an ideal electrical amplifier was used. Based on the eye diagram of the received signal, the signal quality was estimated.

3.2. Signal Quality Measure

The most important signal quality measure used in telecommunication systems is the bit error rate (BER). There are various methods of determining the BER. The most popular of which are the direct approach of counting the errors and the Gaussian approximation method. In the commercial telecommunication systems the required BER is around $10^{-12} - 10^{-13}$. Determining this value in simulations using the direct method is impossible due to the very long simulation time, as this approach would require the transmission (simulations) of at least 10^{14} bits. Gaussian

approximation is an analytical method taking into account only the mean values of 0 and 1 bit levels and their variations [16], which is why this method is broadly utilized. However, it is required that the values of the received signal samples have the Gaussian distribution and that is why it is not useful in the case investigated in the paper. Figure 4 shows the differences between the actual distributions of received signal samples and corresponding Gaussian distributions. It can be seen in the Fig. 4b the distributions differ much from Gaussian distribution. As a result, the indicated BER value is relatively high despite the wide eye opening. This means that in the case of analyzing the signal amplified by the SOA driven into deep saturation, the Gaussian approximation method is ineffective as it would bring unreliable results. In general, it is possible to determine the BER value in the analytical way if the probability density function of the received signal samples is known. Unfortunately, the distribution of the signal samples after the amplification in the SOA has not been determined yet. However, the lowest value of 1 bit does not generally fall below some constant level, while the highest value of 1 bit may vary in the wide range [1], [17], [18]. This lowest value of 1 bit as I_{1th} which can be seen in Fig. 4b. Similarly we denote the highest value of 0 bit as I_{0th} . Therefore, as the received signal quality measure the eye opening of the signal was taken defined as $I_{1th} - I_{0th}$. Since it directly reflects the signal quality, the eye opening width can be considered to be directly related to the BER.

3.3. Simulations

The simulations were carried out as follows: the SOA amplifier was fed with the signals with defined values of 4 parameters: the extinction ratio ER , the line rate B , the input optical power per channel P_{in} and the number of channels Ch . Number of transmitted bits was 4096. Based on Eqs. (1)–(4), the SOA output signal was calculated. The total output power P_{outTot} and the output power per channel P_{out} was measured. Next, the investigated channel was filtered out in the wavelength demultiplexer and attenuated or amplified to achieve the optical power of -15 dBm. The optical signal was converted into electrical domain and the corresponding eye diagram was obtained and analyzed. Finally, in the middle of the bit duration, the eye opening width was measured.

3.4. Results

To make the results independent of the SOA characteristics, the results were normalized in the following way: the optical signal power was normalized with respect to the SOA saturation output power P_{sat} with the relationship $P - P_{out}$ [dB] and the line rate B was normalized with respect to the SOA carriers recovery time t_c with relationship t_c/T_b , where T_b denotes the bit duration. The eye opening width was expressed in the amplitude units. The results of simulations showed that depending on the extinction ratio, line

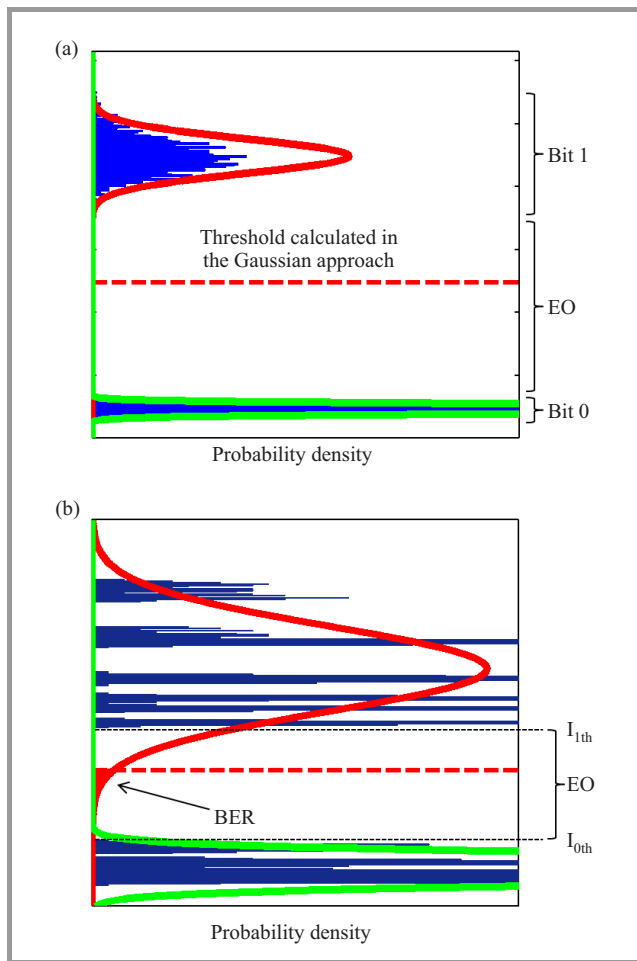

Fig. 4. Distributions of received signal samples and corresponding Gaussian distributions: (a) SOA in shallow saturation, (b) SOA in deep saturation.

rate, the number of channels, and the depth of the SOA saturation, the received optical signal had different eye opening widths. Those widths varied in the range of 30 to 80 amplitude units (change of 4.5 dB). The eye diagrams presented in the Fig. 5 show the eye diagram shape changes depending on the system parameters.

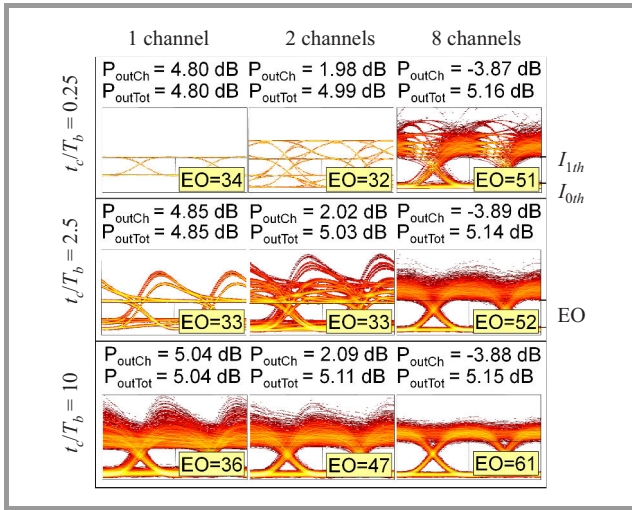

Fig. 5. The signal eye diagrams obtained for different values of line rate and channel number (shown optical power values are normalized).

In general, in the analyzed SOA amplifier, if different signals received with the same optical power generated eye diagrams with the different eye opening widths, then the signal which generated the eye diagram with wider eye opening was less distorted in the SOA. In the Fig. 5 it can be seen that the width of the eye opening increases with the increase of the channel number. The improvement can be explained by the power averaging effect. With the increase of the channel number, the total input signal power shows lower fluctuations around the mean level and therefore the fluctuations of the SOA carrier density and the SOA gain are also smaller. Increase of the line rate shortens the duration time of symbols and therefore reduces the gain variations within a given symbol or symbol group.

In the third column, presenting the results obtained for 8 channels system, it can be seen that increasing the normalized channel line rate from 0.25 to 10 caused the increase of the eye opening width by 10 amplitude units. Along with that increase the concentration of optical power near the I_{1th} level also increased. The values above the I_{1th} level are unwanted, as the decision threshold in the receiver must be set according to the I_{1th} and I_{0th} levels [13]. The increased concentration of 1 bit optical power near the I_{1th} level means the decrease of the power penalty, i.e., eye opening increase, as ideally the whole optical power of 1 bit should be concentrated in the I_{1th} level. Described change indicates the signal quality improvement.

Increasing the output optical power, means driving the SOA amplifier into the deeper saturation. In the Fig. 6 it can be

seen that as the channel number increases the achievable eye opening width also increases. In other words, increasing the channel number leads to the decrease of the signal degradation.

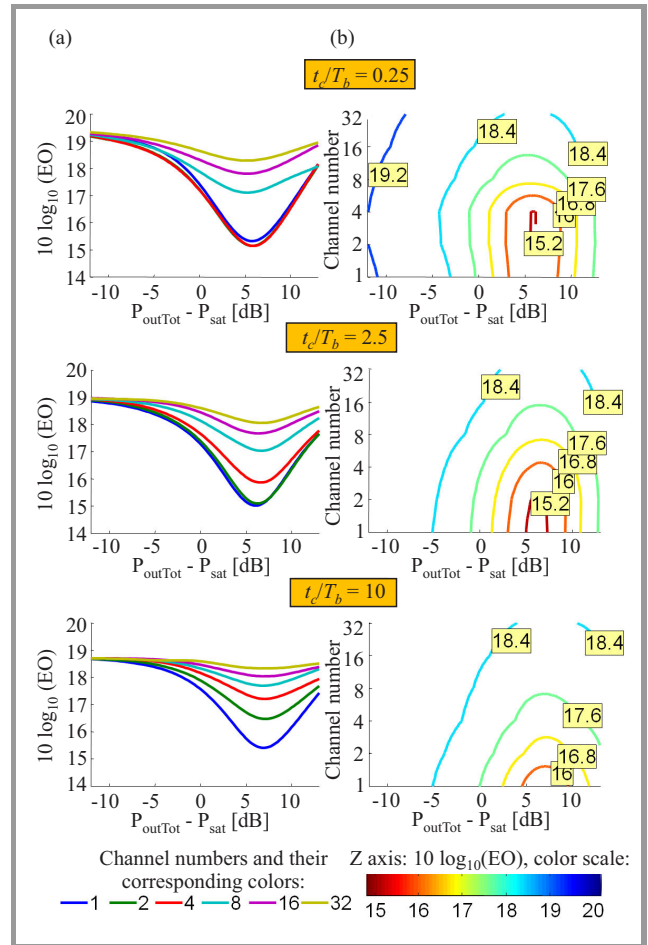

Fig. 6. The eye opening width as a function of the total output power and channel number for the extinction ratio of 10 dB.

What is more, the eye opening width increases with the increase of the line rate, what can be particularly seen for the cases of 2 and 4 channels. In the case of 4 channels the improvement in the eye opening width reached approximately 3 dB. This is evidently the result of the power averaging effect. The biggest increase in the eye opening width can be achieved for the normalized output optical power of 7 dB, in the SOA deep saturation. In the graphs in the “b” column of the Fig. 6, it is clearly seen that in the whole range of the output optical powers increasing the channel number leads to the increase of the eye opening width. The biggest improvement is achieved in the deep saturation of the SOA and it reaches 3 dB.

In the Fig. 7 in the “a” column, it can be seen that even for high channel number it is possible to achieve high output optical power per channel. The increase of the channel number leads to the reduction of the signal degradation. In the graphs in the “b” column it is visible that increase of the channel number (with constant optical power per channel)

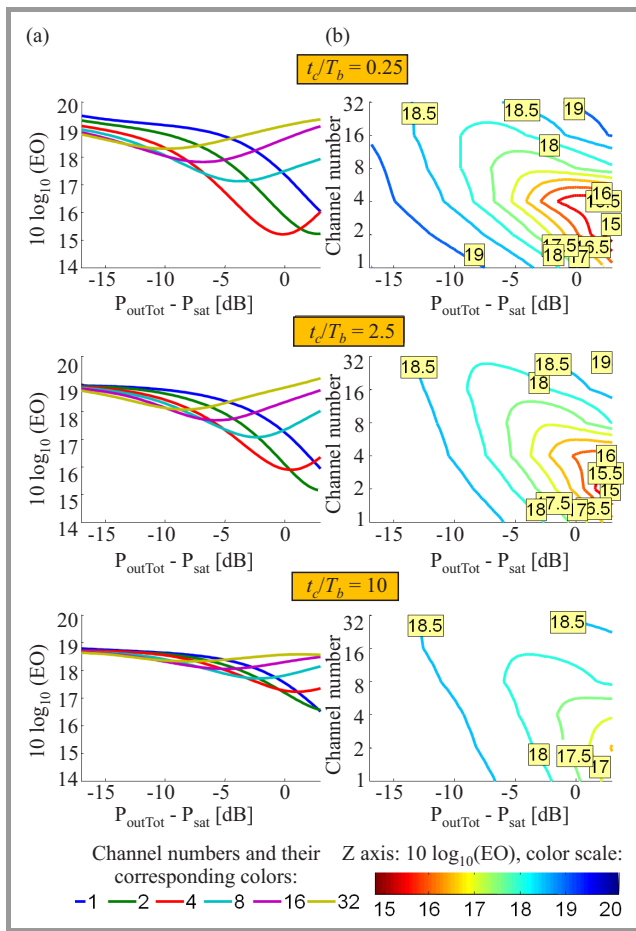

Fig. 7. The eye opening width as a function of the output power per channel and channel number for the extinction ratio of 10 dB.

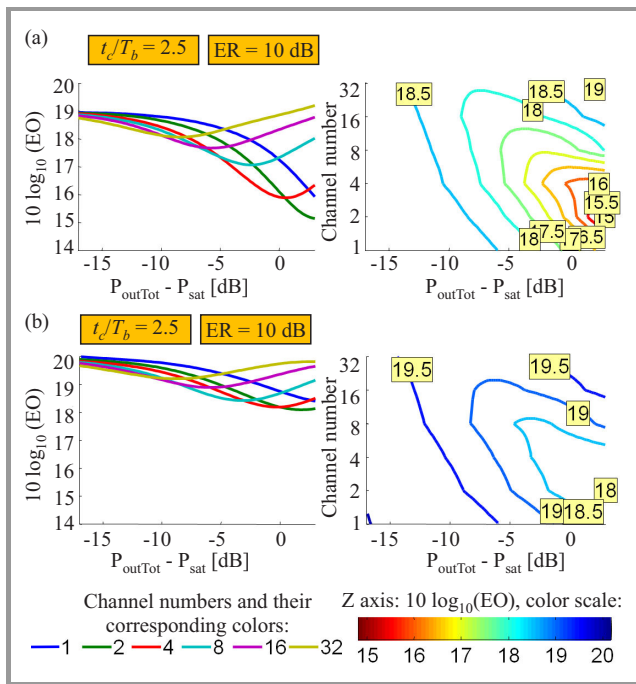

Fig. 8. The eye opening width as a function of the output power per channel and channel number, for the constant line rate and two extinction ratio values: (a) 10 dB and (b) 30 dB.

initially leads to the eye opening width reduction. However, beyond a specific channel number the eye opening begins to increase, in the investigated case of 4 channels. The channel number, above which the improvement is observable, occurs at lower channel number for the high values of the output optical power per channel. Again, the improvement is pronounced for the channels with the short symbol duration.

Figure 8 shows the results of the simulations for two extinction ratios. The 30 dB extinction ratio is achieved in the Mach-Zehnder modulator and the 10 dB one in the electro-absorption modulator. The signals with the 30 dB extinction ratio have overall better signal opening than signals with the 10 dB extinction ratio. For the high extinction ratio signals, the improvement in the signal quality occurs for lower value of the output power.

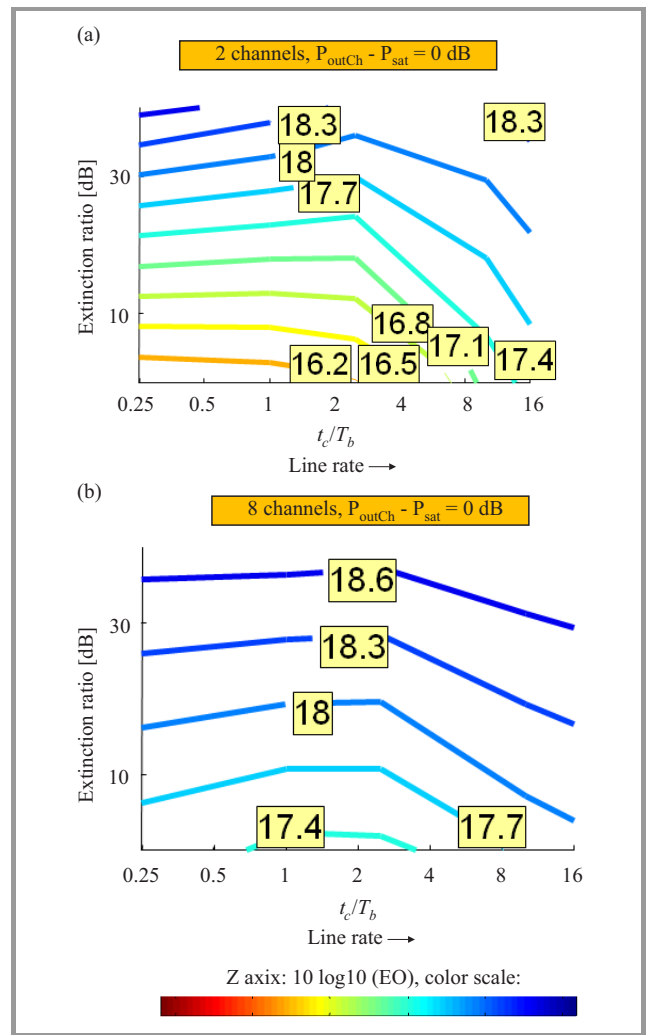

Fig. 9. The eye opening width as a function of the normalized line rate and the signal extinction ratio for: (a) 2 channels and (b) 8 channels, and for the constant normalized output power per channel.

Figure 9 shows the eye opening width as a function of the extinction ratio and the line rate for 2 and 8 channels. Normalized output optical power per channel was constant

and equal to 0 dB, therefore in the second case the total output optical power was 6 dB higher than in the first case, so the SOA was operating in much deeper saturation. In both analyzed cases the improvement of the eye opening width can be achieved by the increase of the line rate (up to 1 dB improvement). The maximal improvement caused by the line rate increase is obtained for the normalized line rate values higher than 3. In 8 channels case, in the whole range of parameters the maximal improvement observed is approximately 1 dB.

Figure 10 presents the eye opening width as a function of the line rate and channel number, for the constant value of total output optical power. In the Fig. 10a, the output optical power was equal to 0 dB and in the Fig. 10b it was equal to 6 dB (deeper saturation). In both analyzed cases the improvement of the eye opening width can be achieved by the increase of the channel number (up to 3 dB improvement) as well the increase of the line rate (up to 1 dB improvement). For the SOA operating in the deep saturation (Fig. 10b) the eye opening widths are 1–2 dB

smaller. It has to be noted, though, that in the (b) case the total output optical power is 6 dB higher what is desired in the DWDM system to achieve longer transmission distance. It can also be seen that higher improvement can be achieved by increasing the line rate and channel number in the deep SOA saturation.

The results of simulations show that for shallow SOA saturation the eye opening widths of the received signals are high and therefore the introduced signal distortions are small. When the SOA is driven into deep saturation, the system with small channel number experiences much higher reduction of the eye opening, while for the system with the high channel number this reduction is lower. For the system with 32 channels the eye opening width reduction is almost negligible.

4. Conclusion

The authors investigated the possibility of counteracting the inter-channel crosstalk and related power penalty in the DWDM system with the utilization of the SOA deep saturation and power averaging effect. Results of conducted simulations show that power averaging effect caused by the increase of the line rate, as well as the channel number in the SOA amplifier, has the strongest positive impact on the signal quality when the SOA amplifier is driven into deep saturation. To maximize the power averaging effect, the SOA should operate with high total output optical power and with many high line rate channels. It is also shown that even for the large channel number it is possible to keep the high output optical power level per channel. The biggest reduction of the signal distortions is observed for the channel number over 4 and with line rate for which the ratio t_c/T_b was more than 2.

Acknowledgements

This work was supported by the Polish National Science Centre NCN under the contract UMO-2011/03/D/ST7/02497.

References

- [1] K. Inoue, "Waveform distortion in a gain-saturated semiconductor optical amplifier for NRZ and Manchester formats", *IEE Proceedings – Optoelectronics*, vol. 144, no. 6, pp. 433–433, 1997.
- [2] IEEE Standard 802.3ba-2010, 18.09.2013 [Online]. Available: <http://standards.ieee.org/about/get/802/802.3.html>
- [3] M. J. Conolly, *Semiconductor Optical Amplifiers*. New York: Springer, 2002.
- [4] A. A. M. Saleh, "Nonlinear models of travelling-wave optical amplifiers", *Electron. Lett.*, vol. 24, no. 14, pp. 835–837, 1988.
- [5] A. Ghazisaeidi, F. Vacondio, A. Bononi, and L. A. Rusch, "Bit patterning in SOAs: Statistical characterization through Multicanonical Monte Carlo simulations", *IEEE J. Quantum Electron.*, vol. 46, no. 4, pp. 570–578, 2010.
- [6] P. Doussiere *et al.*, "Clamped gain travelling wave semiconductor optical amplifier for wavelength division multiplexing applications", in *Proc. 14th IEEE Int. Semicond. Laser Conf.*, Miami, HI, USA, 1994, pp. 185–186.

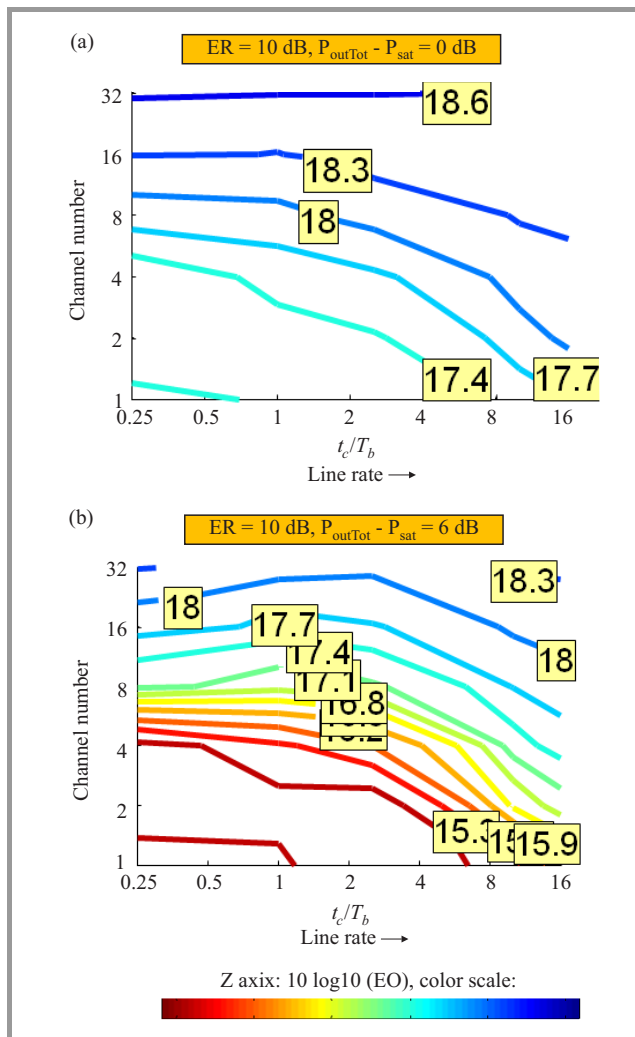

Fig. 10. The eye opening width as a function of the normalized line rate and the channel number, for the constant normalized total output power: (a) 0 dB and (b) 6 dB.

[7] L. H. Spiekman *et al.*, “Transmission of 8 DWDM channels at 20 Gb/s over 160 km of standard fiber using a cascade of semiconductor optical amplifiers”, *IEEE Phot. Technol. Lett.*, vol. 12, no. 6, pp. 717–719, 2000.

[8] Y. Sun *et al.*, “Error-free transmission of 32×2.5 Gbit/s DWDM channels over 125 km using cascaded in-line semiconductor optical amplifiers”, *Electron. Lett.*, vol. 35, no. 21, pp. 1863–1865, 1999.

[9] H. K. Kim and S. Chandrasekhar, “Reduction of cross-gain modulation in the semiconductor optical amplifier by using wavelength modulated signal”, *IEEE Phot. Technol. Lett.*, vol. 12, no. 10, pp. 1412–1414, 2000.

[10] A. H. Guan, H. Yin, and H. L. Fu, “A dispersion management scheme for reducing SOA induced crosstalk in WDM links”, *Guangzi Xuebao/Acta Photonica Sinica*, vol. 38, no. 7, pp. 1790–1793, 2009.

[11] C. R. Doerr, C. H. Joyner, M. Zirngibl, L. W. Stulz, and H. M. Presby, “Elimination of signal distortion and crosstalk from carrier density changes in the shared semiconductor amplifier of multifrequency signal sources”, *IEEE Phot. Technol. Lett.*, vol. 7, no. 10, pp. 1131–1133, 1995.

[12] J. Jennen, H. De Waardt, and G. Acket, “Modeling and performance analysis of WDM transmission links employing semiconductor optical amplifiers”, *IEEE J. Lightw. Technol.*, vol. 19, no. 8, pp. 1116–1124, 2001.

[13] Z. Li, Y. Dong, J. Mo, Y. Wang, and C. Lu, “1050-km WDM transmission of 8×10.709 Gb/s DPSK signal using cascaded in-line semiconductor optical amplifier”, *IEEE Phot. Technol. Lett.*, vol. 16, no. 7, pp. 1760–1762, 2004.

[14] C. R. Doerr *et al.*, “Simple multichannel optical equalizer mitigating intersymbol interference for 40-Gb/s non-return-to-zero signals”, *IEEE J. Lightw. Technol.*, vol. 22, no. 1, pp. 249–256, 2004.

[15] K. Inoue, “Technique to compensate waveform distortion in a gain-saturated semiconductor optical amplifier using a semiconductor saturable absorber”, *Electron. Lett.*, vol. 34, no. 4, pp. 376–378, 1998.

[16] A. A. M. Saleh and I. M. I. Habbab, “Effects of semiconductor optical amplifier nonlinearity on the performance of high-speed intensity-modulation lightwave systems”, *IEEE Trans. Commun.*, vol. 38, no. 6, pp. 839–846, 1990.

[17] M. J. Connelly, “Wideband semiconductor optical amplifier steady-state numerical model”, *IEEE J. Quantum Electron.*, vol. 37, no. 3, pp. 439–447, 2001.

[18] G. P. Agrawal, *Fiber-Optic Communication System*, 4th ed. New York: Wiley, 2010.

[19] R. M. Jopson *et al.*, “Measurement of carrier-density mediated intermodulation distortion in an optical amplifier”, *Electron. Lett.*, vol. 23, no. 25, pp. 1394–1395, 1987.

[20] K. Inoue, “Crosstalk and its power penalty in multichannel transmission due to gain saturation in a semiconductor laser amplifier”, *IEEE J. Lightw. Technol.*, vol. 7, no. 7, pp. 1118–1124, 1987.



Fryderyk M. Dyc received the B.Sc. degree in 2012 and M.Sc. degree in 2013, both in Telecommunications, from the Faculty of Electronics and Information Technology, Warsaw University of Technology, Poland. He completed also post-graduate studies in Management at Warsaw School of Economics. His professional inter-

ests focus mainly on computer science and finding out new ways how technology can improve life.

E-mail: fryderyk.dyc@gmail.com
 Institute of Telecommunications
 Faculty of Electronics and Information Technology
 Warsaw University of Technology
 Nowowiejska st 15/19
 00-665 Warsaw, Poland



Paweł Mazurek received the B.Sc. degree in Data Communications and Telecommunication Management (2012) and the M.Sc. degree in Telecommunications (2014), both from The Faculty of Electronics and Information Technology, Warsaw University of Technology, Poland. Currently he is a Ph.D. student at WUT. His research

interests include high speed and capacity transmission and digital signal processing.

E-mail: p.mazurek89@gmail.com
 Institute of Telecommunications
 Faculty of Electronics and Information Technology
 Warsaw University of Technology
 Nowowiejska st 15/19
 00-665 Warsaw, Poland



Jarosław P. Turkiewicz received the M.Sc. degree in Telecommunications from the Warsaw University of Technology, Warsaw, Poland, in 1998 and Ph.D. degree in Optical Communication from the Eindhoven University of Technology, Eindhoven, The Netherlands, in 2006. From 2007 he is a research expert at Orange

Labs Poland, Warsaw, Poland as well as an assistant professor at Warsaw University of Technology, Poland. He published over 70 peer reviewed papers and contributed and led several national and international research projects. He acts as a reviewer for IEEE PTL, IEEE JLT, Optical Fiber Technology, Electronics Letters as well as was a member of Technical Program Committee of 39th European Conference on Optical Communications (ECOC) 2013. His scientific interests include high speed optical signal transmission and switching. Dr. Turkiewicz was awarded IEEE LEOS Graduate Student Fellowship in 2005 as well as three Warsaw University of Technology awards for scientific and educational achievements.

E-mail: jturkiew@tele.pw.edu.pl
 Institute of Telecommunications
 Faculty of Electronics and Information Technology
 Warsaw University of Technology
 Nowowiejska st 15/19
 00-665 Warsaw, Poland