

CMOS ECCCII with Linear Tune of Rx and Its Application to Current-Mode Multiplier

Chaiwat Sakul

Abstract—In this paper, the second-generation CMOS current-controlled-current-conveyor based on differential pair of operational transconductance amplifier has been researched and presented. Since the major improvement of its parasitic resistance at x-port can be linearly controlled by an input bias current, the proposed building block is then called “The Second-Generation Electronically-tunable Current-controlled Current Conveyor” (ECCCI). The applications are demonstrated in form of both 2 quadrant and 4 quadrant current-mode signal multiplier circuits. Characteristics of the proposed ECCCII and its application are simulated by the PSPICE program from which the results are proved to be in agreement with the theory.

Keywords—Electronically tunable, CCCII, Current mode, CMOS, Linear

I. INTRODUCTION

CURRENT-CONVEYOR is an analogue signal operating circuit that can be applied in conjunction with other electronic circuits, generating much more useful analogue signal processing circuits in current mode by means of circuit building. Analogue operating circuits in current mode take the advantages of accurate circuit gain and wide operating frequencies compared to those in voltage mode. Current-conveyor has been developed continually, starting from the first generation introduced in 1968 by K.C. Smith and A.S. Sedra [1] called the First-Generation Current-Conveyor (CCI). Two years later in 1970, they improved and launched the second-generation called CCII with distinct features and ease of application over the original CCI. [2] A wildcard characters and principles represented by CCII have led to a range of practical applications in current-mode functioning circuits in various forms as evidenced in number of concerning literatures. [3]

This second-generation current-conveyor had been later modified, where its impedance at the input terminal “x” can be adjusted by external bias current and it was then called a current-controlled-current-conveyor, symbolized as CCCII. [4] The CCCII consists of a translinear loop as the input section with a wide-range of DC-transfer characteristic controllability. Though translinear structure is simple, the large offset voltage and poor voltage following performance are still reported as well as the large number of MOSFETs used in circuit. [7] [13] Besides, whenever the circuit is constructed from bipolar transistor, its resistance always varies to terminal voltage. This was regarded as a weakness of the circuit. Generally bipolar junction transistor (BJT) is usually employed to reduce the resistance at the terminal “x” of CCCII in linear form however

it is more difficult to use BJT in designing an integrated circuit compared to the use of CMOS.

Thus, from the measures mentioned above, this article presents the development of the second-generation current-controlled-current-conveyor CCCII, where its resistance at “x” terminal can be linearly tuned by external current supply using the bias of operational transconductance amplifier (OTA) along with a MOS transistor structure. [9] [16] The designed circuit which implements the basis of differential pair together with current mirror can be activated and controlled by low current signal from external source, provided that all MOS transistors are working in saturation region as shown in Figure2. From the structure in Figure2, it is developed to the second-generation current-controlled-current-conveyor as shown in Figure3 where resistance at the “x” terminal of CCCII is normally constructed by MOS transistor. The equation of the resistance is, however, still under square-root as described in equation (4). Therefore this article has proposed a CCCII to solve the problem as shown in equation (9). It is found that on a certain range of current, the circuit can be electronically and linearly controlled and can function properly at high frequency. The circuit with simple structure is suitable for implementation in analogue integrated circuits. CCCII can be finally applied to current-mode signal multipliers.[10] [11] The simulations results tested by PSPICE program confirm high performance of the circuit in terms of good linearity in current-mode operations. [12] [14] [20]

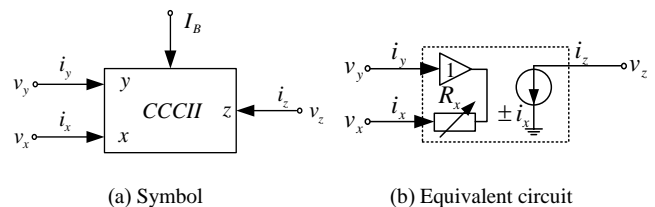

Fig.1. Symbol and equivalent circuit of CCCII

II. SECOND-GENERATION ELECTRONICALLY CURRENT-TUNEABLE CURRENT CONVEYOR

A. Principle of CCCII

The second-generation current-control-current-conveyor is an electronic device functioning in current mode with four terminals. CCCII was originally presented by A. Fabre et.al in 1995, which had been developed from the second-generation current-conveyor (CCII); however CCCII has a unique feature over the former CCII since its parasitic resistance at the input terminal can be controlled by external bias current. [3] [6] [8]

Details of this character will be further discussed. The four terminals of CCCII can be divided into three groups: two terminals for input (x and y), one terminal for output (z) and one terminal for controlling current (I_B). The symbol and equivalent circuit of CCCII are shown in Figure 1 (A) and (B), respectively.

From the equivalent circuit in Figure 1(B), a voltage buffer is found at the terminal “y”, which results in so high resistance that current cannot flow into ($i_y = 0$) or in other words; it is suitable to supply voltage input through terminal “y”. On the contrary, there is an adjustable resistance (R_x) at the “x” pole, which can be controlled by the bias current (I_B). As a consequence, terminal “x” is suitable for current input supply. Current value at terminal “z” is equal to those flows through terminal “x” ($i_z = i_x$). Noted that if the currents at the terminal “x” and “z” of CCCII flow in the same direction, it is called a positive CCCII or CCCII+ (the plus symbol is rarely used). In contrast, if the currents at terminal “x” and “z” flow in the opposite direction, it is called a negative CCCII or CCCII-. Normally, the use of current mirror helps create multiple terminals at the terminal “z” of CCCII and it is known as multi-output CCCII (MO-CCCII). Ideally, the resistance at the terminal “z” of CCCII is infinite; therefore the features mentioned above can be represented by an equation in terms of matrices as follows.

$$\begin{bmatrix} i_y \\ v_x \\ i_z \end{bmatrix} = \begin{bmatrix} 0 & 0 & 0 \\ 1 & R_x & 0 \\ 0 & \pm 1 & 0 \end{bmatrix} \begin{bmatrix} v_y \\ i_x \\ v_z \end{bmatrix} \quad (1)$$

The current output at terminal “z” (i_z) that is conveyed from the current input at terminal “x” (i_x) is expressed as [5].

$$i_x = i_z = \frac{v_x - v_y}{R_x} \quad (2)$$

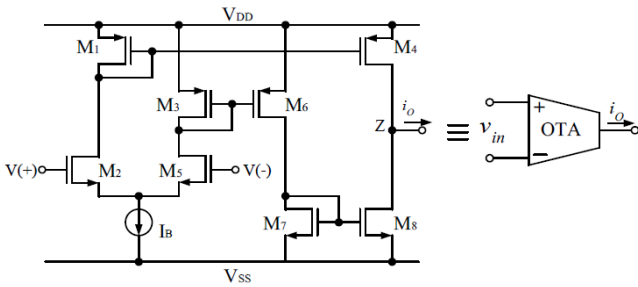

Fig.2. CMOS-based OTA Structure

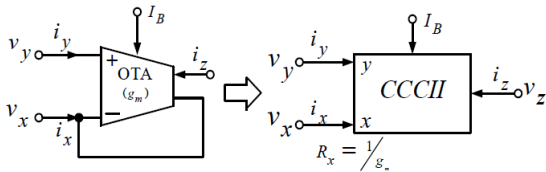

Fig.3. Building CCCII from OTA

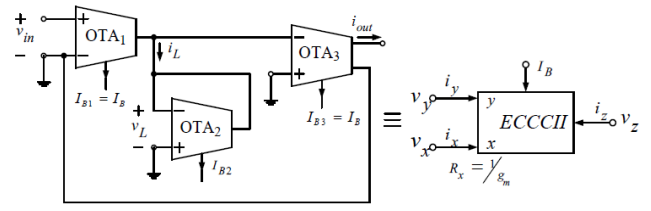

Fig.4. Building ECCII from OTA

B. Building CCCII from OTA

The circuit in Fig.2 shows the structure of operational transconductance amplifier (OTA) using MOS transistor as the basis of designing and Fig.3 shows a building of CCCII from OTA where the circuit consists of two parts: the first part is a differential pair in which M2 and M5 are compatibly merged; the second part is the negative current mirror. The negative current mirror with PMOS component consists of two functional sets; the first set containing M3, M6, M7 and M8 reflects the drain current of M5 to M8, resulting in $i_{D5} = i_{D8}$ while the second set containing M2 and M4 reflects the drain current of M2 to M4, resulting in $i_{D2} = i_{D4}$ respectively. Thus, the output current at terminal “z” is described as $i_o = i_{D5} - i_{D2}$, where $i_o = i_z = i_x$, in accordance with the terms in equation (1) of CCCII. Increasing current output can be done by adding more MOS transistors to the current mirror. When input voltage (v_{in}) appears at terminal “y” ($v_y = v_{in}$), input voltage at terminal “x” works the same (v_{in}) according to the properties of OTA. Consequently, the thermal voltage v_x / v_y is calculated as follows:

$$v_x = \left[\frac{g_m}{g_m + g_d} \right] v_y \quad (3)$$

When g_d is drain conductance of MOS transistor M2 and g_m is transconductance of MOS transistor M5, respectively. Generally, g_d is notably less than g_m so from equation (3), the relationship between v_x and v_y appears equal. Determining resistance at the terminal “x” of MOS transistor-base OTA circuits can be done by analyzing the correlation of the transconductance as shown in the following equation. [2]

$$R_x = \frac{1}{g_m} = \frac{1}{\sqrt{8\mu_0 C_{OX} \frac{W}{L} I_B}} \quad (4)$$

When $g_m = \sqrt{2I_B K}$ for $-\sqrt{I_B/K} \leq v_{in} \leq \sqrt{I_B/K}$ and $K = \mu_0 C_{OX} (W/2L)$, considering the conditions in equation (4), it is found that the resistance at terminal “x” can be tuned by external current (I_B), however the weakpoint is that the equation remains under square-root. Under the certain restrictions of current convey where resistance at the terminal “x” needed to be zero first before the terminals voltage at “x” and “y” can be equally adjusted and later the circuit can functions linearly so CCCII must be modified to be linearly tuned by forming the circuit in agreement with the structure shown in Fig.4.

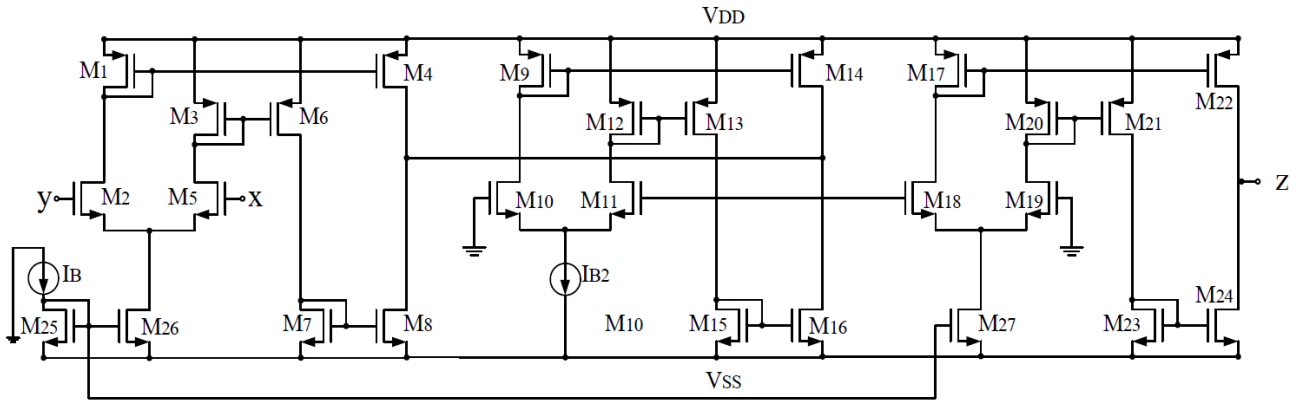
 Fig.5. Proposed CMOS ECCII with linear tune R_x

Square-root is then taken off and the terminal “x” of CCCII can be linearly tunable.

C. Creating the CMOS CCCII with Linear Tune of R_x

The structure of the circuit in Fig.4 provides an external current controlled CMOS CCCII with electrically linearly tune of R_x . The circuit consists of three sets of CMOS with operational transconductance amplifier (OTA) integrated together. [4]

The circuit functions when the OTA₁, receives input voltage ($v_{in} = v^+ - v^-$), giving that output is current (i_L). The output of OTA₁ is transformed to be the input of OTA₂ which will act as load $z_L = 1/g_{m2}$ and load current is as $i_L = g_{m1}v_{in}$ therefore, the voltage drops across the active resistor (OTA₂) shows in equation (5).

$$v_L = i_L z_L = \frac{g_{m1}v_{in}}{g_{m2}} \quad (5)$$

Thus, Fig.4 shows that the input value of the OTA₃, is v_L , the output current is calculated as the following equation (6).

$$i_{out} = g_{m3} v_L \quad (6)$$

From equation (5) and (6), the output current of ECCII can be substituted and rewritten as shown in equation (7).

$$i_{out} = \left(\frac{g_{m1} g_{m3}}{g_{m2}} \right) v_{in} \quad (7)$$

Where $g_{m1} = \sqrt{2I_{B1}K_1}$, $g_{m2} = \sqrt{2I_{B2}K_2}$, $g_{m3} = \sqrt{2I_{B2}K_3}$, given that $I_{B1} = I_{B3} = I_B$ thus, the equation (7) can be substituted and rewritten as shown in equation (8).

$$i_{out} = \left(\frac{2I_B \sqrt{K_1 K_3}}{\sqrt{2I_{B2}K_2}} \right) v_{in} = g_{mT} v_{in} \quad (8)$$

From equation (8), g_{mT} of the EOTA in Fig.4 is described as:

$$g_{mT} = 2I_B K_T \quad (9)$$

Where $K_T = \sqrt{K_1 K_3} / \sqrt{2I_B K_2}$ is the circuit constant, thus from equation (9), it is found that the transconductance of the transconductance gain can be linearly expanded by means of electronic control. Feeding reverse output current (i_{out}) from OTA₃ backward to OTA₁, the EOTA is found to function as CCCII. On the other hand, it means that the circuit presented in Fig.4 operates as the second-generation current-conveyor under the condition of external current control (I_B). From the conditions mentioned above, determining the resistance at the terminal “x” results in the fact that the current input of the OTA₁ is equal to the current output of the OTA₃. Therefore, the resistance at the terminal “x” in equation (8) is same as in equation (10) and the resistance at the terminal of proposed CCCII “x” (R_x) can be linearly tuned using electronic methods.

Moreover, this result helps solve the problem in equation (4) from which the square-root needs to be extracted. By determining circuit building block in Fig.4, the final structure of modified CCCII is then present in Fig.5 as called Second-Generation Electronically tunable Current-controlled-Current Conveyor (ECCII). Therefore, the proposed ECCII in this article has been appraised to be highly potential for further applications. [17] [18] [19]

The process of ECCII can be simply explained as a circuit with non idealistic condition between terminal x and Y where they can be controlled by parasitic resistance adjustment as shown in Fig.1 (b) A good CCCII needs the resistance value at terminal X to be zero or least so that the voltage at both terminal X and Y can be equal. Hence the equation (9) can be calculated and rewritten as shown in equation (10)

$$R_x = \frac{1}{g_{mT}} = \frac{1}{2I_B K_T} \quad (10)$$

In comparison with the past CCCII with CMOS bias as described in equation (4), it is noticed that the multiplier of the constant is 8 and the equation get stuck in a square-root while one in equation (10) is only 2 and the equation itself is now in non square-root form. This result is the distinct advantage of the proposed circuit that can be further applied as a good CCCII.

III. ECCCII-BASED APPLICATIONS OF CURRENT-MODE SIGNAL MULTIPLIER CIRCUIT

The applications of the second-generation electronically tunable current-controlled-current-conveyor (ECCCII) are carried out and demonstrated here in a couple of simple model; 2-quadrant and 4-quadrant current-mode signal multiplier circuits.

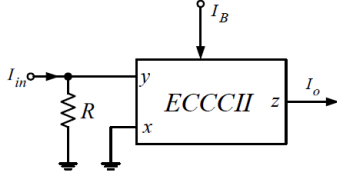

Fig.6. ECCCII-based 2-quadrant current-mode signal multiplier circuit

A. ECCCII-based 2-quadrant current-mode

A simple 2-quadrant signal current multiplier circuit is demonstrated as shown in Fig.6. Where input current is fed at terminal “y” of ECCCII and terminal “x” is connected to ground, the output current is equal to the currents at terminal “x” and “z” with I_B as the external controlling current. Thus, the value obtained from output current equation is equal to the external current (I_B) multiplied by input current (I_{in}). The relationship of equation (11) towards equation (13) is shown respectively as follows.

$$V_y = I_{in} R \text{ And } I_x = \frac{V_y}{R_x} \quad (11)$$

Therefore, from equation (11) the current value at terminal “x” is calculated and can be rewritten in equation (12) as.

$$I_x = I_{in} \left(\frac{R}{R_x} \right) \quad (12)$$

Consider operating conditions of the CCCII, it is found that $I_o = I_x = I_z$. In another word, the output current is equal to the current at terminal “x” in the equation (12). Thus, plucking R_x value received from equation (10) into equation (12), the output current can be gained in equation (13) as.

$$I_o = 2K_T R I_B I_{in} \quad (13)$$

B. ECCCII-based 4-quadrant current-mode

A simple 4-quadrant signal current multiplier circuit is demonstrated as shown in Fig.7. The circuit of a couple ECCCII merged together consists of ECCCII₁ and ECCCII₂. Whereas input current is fed at terminal “y” of ECCCII₁, terminal “x” of all ECCCII are connected to ground and the output current functions as the currents at terminal “z” of ECCCII₂. The output current of the circuit is the summation of I_{z1} and I_{z2} as shown in their respective relationships from equation (14) to (17) as follows.

$$\text{From } I_{z1} = I_{in1} \left(\frac{R_{x2}}{R_{x1}} \right) \quad (14)$$

$$\text{And } I_{z2} = -I_{in1} \quad (15)$$

$$\text{Thus } I_o = I_{z1} + I_{z2} \quad (16)$$

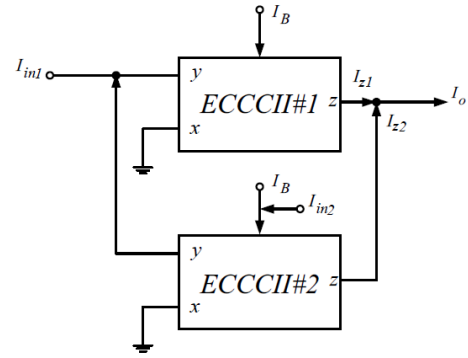

Fig.7. ECCCII-based 2-quadrant current-mode signal multiplier circuit

TABLE I
THE WIDTH TO THE LENGTH OF THE CHANNEL OF MOS-TRANSISTOR

Transistor	W/L ($\mu\text{m.} / \mu\text{m.}$)
M1,M3,M4,M9,M12,M14,M17, M20,M22	5.0.25
M2,M5,M10,M11,M18,M19	25.0.25
M6,M13,M21	4.5.0.25
M7,M8,M15,M16,M23-M27	3.0.25

Where $R_x = \frac{1}{2I_B K_T}$ and $R_x = \frac{1}{2(I_B + I_{in2}) K_T}$ plucking in equation (14) and the output current relationship is in accordance with equation (17).

$$I_o = I_{in1} \left(\frac{I_B}{(I_B + I_{in2})} - 1 \right) = - \frac{I_{in1} I_{in2}}{(I_B + I_{in2})} \quad (17)$$

IV. SIMULATION RESULTS

Figure 5 displays the second-generation current-controlled-current-conveyor where external current is demanded and R_x is linearly and electronically tunable. The performance of the proposed circuit is realized and confirmed through PSPICE simulation using the parameters of TSMC CMOS technology at $0.25 \mu\text{m.}$ with the width to length ratio (W/L) of the channel as displayed in Table I.

Given that, $V_{DD} = 1.25 \text{ V}$, $V_{SS} = -1.25 \text{ V}$ while $I_B = 200 \mu\text{A}$ and $I_{B2} = 100 \mu\text{A}$ and load resistance is $1 \text{ k}\Omega$. The types of MOS transistor are N-channel and P-Channel with the threshold voltage (V_T) configuration as 0.42 V and -0.55 V , respectively. The results of the simulation are displayed as follows.

Fig.8 shows the relationship between the resistance at terminal “x” of the circuit in Fig.5 and the external current control. By defining the certain range of current from $1 \mu\text{A}$ to 1 mA which is the most linear condition and the scope of interest in this paper, it is found that at current of $1 \mu\text{A}$, the resistance is approximately at $40 \text{ M}\Omega$ and when current increases, the resistance at terminal “x” decreases significantly inversely in relationship.

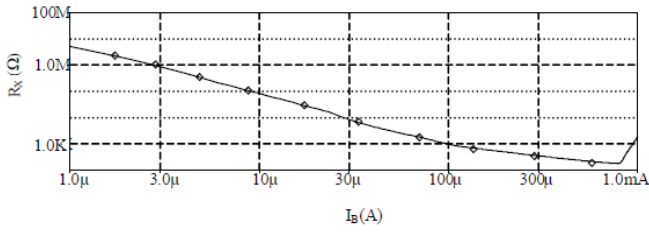

Fig.8. Resistance characteristics (R_x).

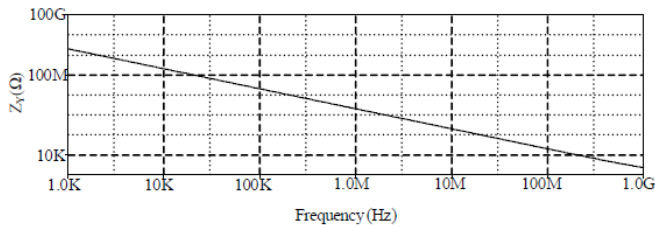

Fig.9. Impedance characteristics (Z_y).

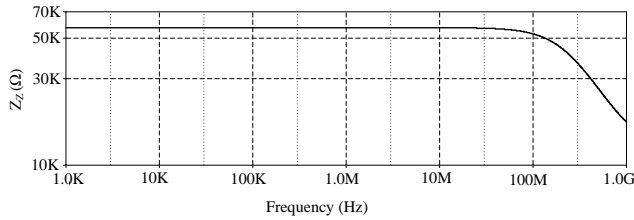

Fig.10. Impedance characteristics (Z_z).

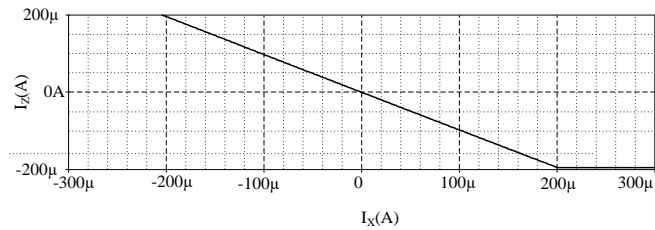

Fig.11. Current transfer characteristics (I_z).

Fig.9 shows the relationship of the impedance at terminal “y” of ECCII in Fig.5 when in the certain frequency range at, the impedance is approximately 40 GΩ and when encountered higher frequency around 1GHz , the impedance decreases to about 5kΩ . The relationship bears in linear form as well. Fig.10 shows the relationship of the impedances at terminal “z” of ECCII in Fig.5. When simulation is conducted in the frequency range from 1kHz to 1GHz , all impedances at terminal “z” remain equal with the value around 58kΩ at lower 60 MHz and later decrease inversely to frequency enlargement. Fig.11 shows the relationship between the current at terminal “x” and terminal “y” of ECCII tested by varying current at terminal “x” from $-200\mu A$ to $200\mu A$. The relationship conforms to the equation (2) that $I_x = I_z$.

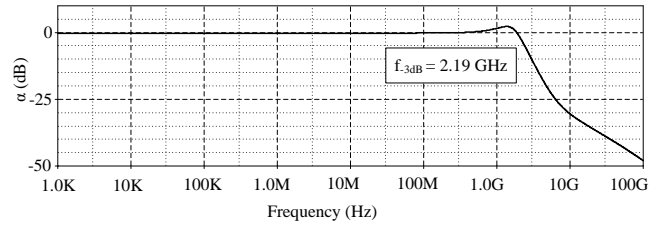

Fig.12. Frequency response of alpha test

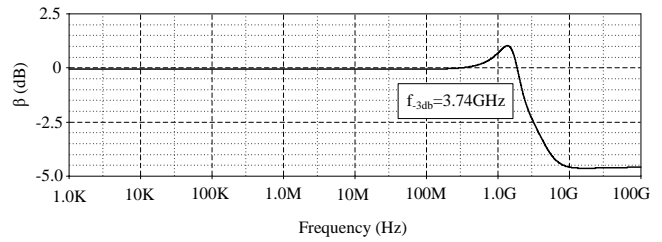

Fig.13. Frequency response of beta test

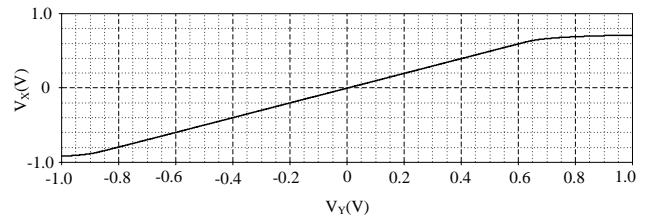

Fig.14. Voltage transfer characteristics

Fig.12 and 13 display the frequency responses of the ECCII. The frequency responses of circuit value about 2.19 GHz for alpha test (α) and about 3.74 GHz for beta test (β) respectively, therefore the proposed circuit is highly recommended to be applied with circuits operating at high frequency. Fig.14 shows the relationship graph of voltages at terminal “x” and terminal “y” where the circuit can be linearly optimized at $\pm 0.6 V$. Where alpha and beta represent current and voltage transfer gain respectively.

Determination of the second-generation electronically tunable current-controlled-current-conveyor functional properties is carried out by designing a 2-quadrant current-mode signal multiplier circuit as shown in Fig.6 and a 4-quadrant current-mode signal multiplier circuit as shown in Fig.7 It is found that the current output is multiplication result of input current with the external current as shown in the equation (13). Fig.15 and Fig.16 describes the finding of DC properties of the circuit by supplying DC input at $\pm 100\mu A$ and having it tested with four-external currents with the values of 0 A, $50\mu A$, $75\mu A$ and $100\mu A$,respectively. Fig.17 shows the results of output current from the multiplier circuits when input current is in sign-wave form with the amplitude at $100\mu A$ and frequency at 10 kHz while the external current control is in triangular-wave form with the amplitude at $50\mu A$ and frequency at 1kHz .The circuit is found to carry off correct properties according to the proposed theory.

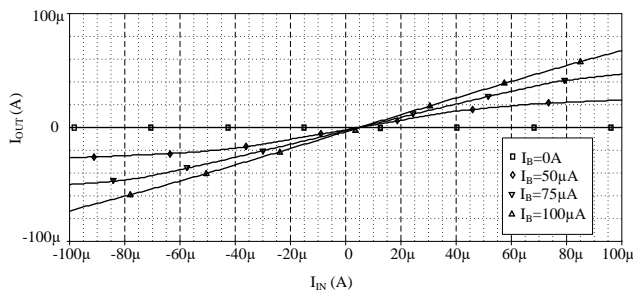

Fig.15. Simulation DC Transfer characteristic of the 2-quadrant multiplier

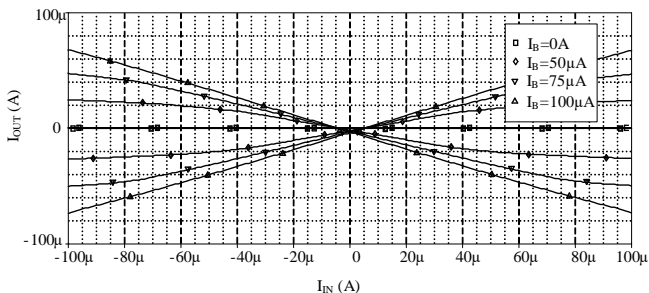

Fig.16. Simulation DC Transfer characteristic of the 2-quadrant multiplier

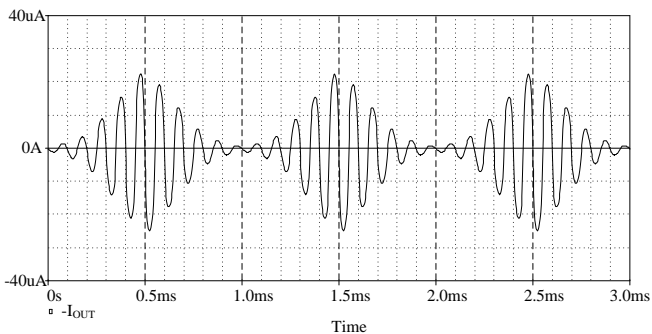

Fig.17. Simulated transient response of the multiplier circuit

V. SUMMARY

The design of the second generation electronically tunable current-controlled-current-conveyor supplied by external current source makes use of multi-organized MOS transistors to create an operational transconductance amplifier which functions in saturation region. Later, three sets of EOTA are connected and transform to ECCCII. The designed circuit can adjust the latency resistance at the terminal “x” of ECCCII linearly by using the electronic methods. The performance of the proposed circuit is discussed and tested through PSpice simulation program to confirm the proper functions of the circuit according to the theory. The ECCCII is, in addition, applied to 2-quadrant and 4-quadrant current-mode multiplier circuit in order to prove the effectiveness of the proposed circuit with high potential for further development in forms of integrated circuits.

REFERENCES

- [1] K. C. Smith, A. Sedra, “The current conveyor-a new circuit building block,” in *Proc. of IEEE*, vol. 56, Issue.8, pp. 1368-1369 , Aug. 1968.
- [2] A. Sedra, K. C. Smith, “A second-generation current conveyor and its application,” *IEEE Trans on Circuit theory*, vol.17,.., pp. 132-134, Feb 1970.
- [3] A. Fabre, O. Saaid, F. Wiest and C. Boucheron, “Current controlled bandpass filter based on translinear conveyors,” *ELECTRONICS LETTERS*, vol. 37, no.1, pp. 1727-1728, Sep. 1995.
- [4] K. Kaewdang, W. Surakamponorn, “On the realization of electronically current-tunable CMOS OTA,” *Int. J. Electron. Commun. (AEÜ)*, vol.61, pp. 300-306, 2007.
- [5] A. Fabre, O. Saaid and C. Boucheron, “High Frequency Applications Based on a New Current Controlled Conveyor,” *IEEE Trans on circuits and systems*, vol.43, no.2, pp. 82-91, Feb. 1996.
- [6] R. Chaisricharoen, B. Chipipop, B. Sirinaovakul, “CMOS CCCII: Structures, characteristics, considerations,” *Int. J. Electron. Commun. (AEÜ)*, vol.64, pp. 540-557, 2009.
- [7] W. Thitopakarn, R. Chaisricharoen, B. Chipipop and K. Higuchi, “Novel CMOS Current Controlled Current Conveyor Transconductance Amplifier (CCCCTA). *ISCIT 2010*, pp.916-921, 2010.
- [8] S. Minaei, “BiCMOS realization of the second-generation current controlled conveyor (CCCII) and its application,” *Proc. of Int. Symp. Sign. Circ. Syst. SCS2001*, pp.421-424, 2001.
- [9] W. S. Chung, K.H. Kim, H.W. Cha, “A linear operational transconductance amplifier for instrumentation applications,” *IEEE Trans Instrum. Meas.*, pp.441-443, 1992.
- [10] S. Minaei, D. Kaymak, M. A. Ibrahim, K. Kuntman, “New CMOS configurations for current-controlled-conveyors (CCCIIs),” *Proc of IEEE Conf. on Circuits and Systems for Communications (ICCS)*, pp.62-65, Jun 2002.
- [11] T. Katoh, T. Tsukutani, Y. Sumi, Y. Fukui, “Electronically tunable current-mode universal filter employing CCCII and grounded capacitors,” *Proc of the Int’l Symp. On Intelligent Signal Processing and Communications (ISPACS)*, pp.107-110, Dec. 2006.
- [12] Y. H. Xi, L. Liu, “A novel CMOS current controlled conveyor II and its applications,” *Proc of the Int’l conf. on Intelligent Communication Technology and Automation (ICICTA)*, pp. 631-637, Oct. 2008.
- [13] H. Ercan, S. A. Tekin, M. Alci, “Voltage- and current-controlled high CMRR instrumentation amplifier using CMOS current conveyors,” *Turk J Elec Eng & Comp Sci*, vol.20, no.4, pp. 547-556, 2012.
- [14] S.J.G. Gift, B. Maundy, F. Muddeen, “High-performance current-mode instrumentation amplifier circuit”, *International Journal of Electronics*, vol. 94, pp. 1015-1024, 2007.
- [15] Y.H. Ghallab, W. Badawy, K.V.I.S. Kaler, B.J. Maundy, “A novel current-mode instrumentation amplifier based on operational floating current conveyor”, *IEEE Trans on Instrum Meas.*, vol. 54, pp.1941-1949, 2005.
- [16] H. Ercan, M. Alci, “A new design for a BiCMOS controlled current conveyor,” *Journal Electronics and Electrical Engineering*, vol.19, pp. 56-60, 2013.
- [17] M. Kumngern, J. Chanwutitum, K. Dejhan, “Electronically tunable multiphase sinusoidal oscillator using translinear current conveyors,” *Analog Integrated Circuits and Signal Processing*, vol. 65, pp. 327-334, 2010.
- [18] M. Kumngern, W. Jongchanavawat, K. Dejhan, “New electronically tunable current-mode universal biquad filter using translinear current conveyors,” *International Journal of Electronics*, vol. 97, pp. 511-523, 2010.
- [19] N. A. Shah, M. F. Rather, S. Z. Iqbal, “SITO electronically tunable high output impedance current-mode universal filter,” *Analog Integrated Circuits and Signal Processing*, vol. 47, p. 335-338, 2006.
- [20] B. Razavi, “Design of analog CMOS integrated circuits,” *McGraw Hill*, Singapore, pp. 596-597, 2001.