

An experimental study of interceptor's effectiveness on hydrodynamic performance of high-speed planing crafts

Mohammad Hosein Karimi, Ph.D. Student,
Mohammad Saeed Seif, Prof.,
Madjid Abbaspoor, Prof.,
Sharif University of Technology, Iran

ABSTRACT

Trim control mechanisms such as interceptors and trim flaps have been widely used in recent years in high-speed crafts for ride and trim control. In spite of their extensive application, a few studies investigating the impact of interceptors on planing craft performance, have been published. In the present study, the impact of interceptors on planing crafts hydrodynamic quality is investigated through application of an experimental method. Two scaled-down models of high-speed planing mono-hull and catamaran are tested with and without interceptors in calm water at different heights of the interceptors to investigate the effect of interceptors on drag reduction of the models. The first one is a scaled-down model of 11 m planing mono-hull boat and the test was conducted at the towing tank of Sharif University of Technology, Iran. The second one is a scaled-down model of 18 m planing catamaran boat and the test was conducted at the towing tank of Krylov Shipbuilding Research Institute (KSRI), Russia. The experimental results show a remarkable drag reduction of up to 15% for mono-hull model and up to 12% for catamaran model over the wide speed range of the models.

Keywords: interceptors; drag reduction; hydrodynamic quality; planing catamaran; mono-hull

INTRODUCTION

Interceptors have been used for trim and ride control of planing and semi-planing boats since the 1970s and the application of these devices has steadily increased over the years. Interceptors are nowadays also used for steering and motion control of high speed crafts. An interceptor is a thin plate or blade, protruded from the hull normal to the flow direction causing a stagnating flow region near the blade. The resultant pressure acts on the hull bottom creating the effects such as the trim moment, which adds lift and finally controls the attitude of the craft. The interceptors are normally installed at the boat transom and/or amidships or at a distance ahead of transom depending on the boat loading, position of the centre of gravity and initial trim. Hydraulic or electric actuators adjust the height of the interceptors and the blades can be retracted completely when they are not needed. The most common application of interceptors is to serve as a trim control device that can help to reduce the overall resistance of planing vessel. There is also another way to decrease the resistance of a planing vessel by means of interceptors, i.e. through installing the interceptor amidships. This results in the reduction of the wetted area, both by increasing the dynamic lift and creating an air cavity behind the interceptors. The magnitude of the lift created by the interceptors normally depends on their height and flow velocity. However, there are other parameters possible to have an

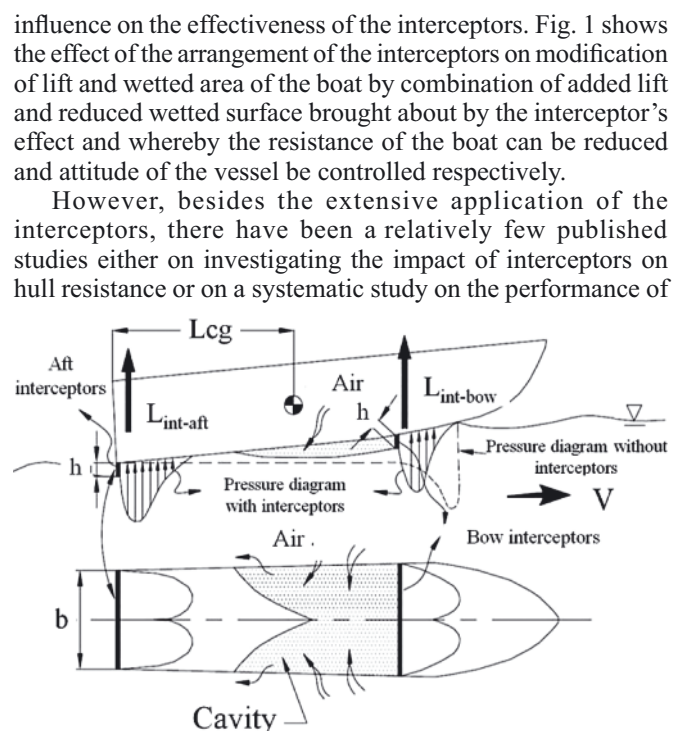

Fig. 1. Illustration of physical phenomena associated with interceptors

these devices. Thus, the present study aims at improving the understanding of the impact of interceptors on hull resistance by reviewing the published literature sources, examining the impact of the interceptors on hydrodynamic quality of planing mono-hull and catamaran through an experimental study, and to develop further insight into the procedures by which interceptors can cause reduction of resistance.

LITERATURE REVIEW

The effect of stern wedge on ship powering performance of planing and semi-planing vessels has been studied by several researchers [1]. Bannikov, Bannikova et al. experimentally investigated the transom interceptor influence on the hydrodynamic characteristics of planing surfaces with 0.3 m beam, dead rise angle of 0, 15 and 30 deg at 4-9 m/s speed, at different heights of the interceptor, and derived an empirical formula for the added lift and drag of planing surfaces [2, 3]. By using several planing surfaces and flat plates' experimental results, Savitsky devised a computational procedure to evaluate the performance of a planing hull. The foregoing procedure is used in calculating the running trim and resistance at a given running speed as well as the load and location of the centre of gravity [4].

Like interceptors, the trim flap has also been widely used on semi-planing and planing vessels and there is a large amount of published data on its performance. A thorough investigation was conducted by Brown as "an experimental and theoretical study of planing surfaces with trim flaps" [5]. Furthermore, the effect of the trim flaps was implemented to the planing boat model by Savitsky and Brown [6].

Tsai et al. carried out a model test on a 1/20 scale model of 20 m patrol boat at designed speed of 40 knots and a 1/10 scale model of a 29.5 m patrol boat at designed speed of 32 knots, including interceptors and with and without stern flaps. The application of even small interceptors (h/L of the order of 0.1%) changed the trim and as a result reduced the resistance considerably (up to 17% at interceptor height of 0.5, 1, 1.5 mm in model scale) [7, 8].

The Krylov Shipbuilding Research Institute also performed several tank tests on catamaran and mono-hull models to explore the effectiveness of interceptors on resistance reduction and motion control of high speed crafts [9, 10].

A new formulation has been developed by Dawson and Blount as the basis to predict the equivalent lift of interceptors [11].

Brizzolara carried out one of the most detailed studies on interceptor's hydrodynamics. He used a CFD method to study the local flow around a 2D interceptor fitted to a flat boundary, which represented the hydrodynamic flow around the bottom of a ship and was the most idealized model of interceptors ever used. This model allowed for viscous effects and through limited series of CFD-based simulations provided the relationships between the hydrodynamic forces and the interceptor's main parameters [13]. Successively, Molini and Brizzolara introduced a simple potential flow model for the predicting of pressure and lift forces in front of the interceptors [14]. D.Villa and Brizzolara put forward a new study, which changes context and approach considerably in comparison with the previous ones. In fact, CFD-based hydrodynamic models consider the complete description of planing hull form with stern appendages. Of course, not only interceptors but also stern flaps have been considered with the scope to compare relative performance; the CFD solution with RANES solver were used to simulate the flow around planing hulls and stern appendages more precisely [15].

In a series of M.Sc.-theses elaborated in the Department of Marine Technology at Norwegian University of Science and Technology (NTNU), Norway, their authors tried to establish a database for performance data on lift and drag of interceptors installed at the transom of prismatic planing hulls. Sverre Steen summarized the experimental results suggesting various approaches to empirical formulas for the coefficients of added lift and drag due to interceptors [16].

Alterskjar performed the tank test of the model of 26 m catamaran with stern and mid-interceptors in calm water and waves to investigate whether the application of stern and mid-interceptors could help reducing the calm water resistance and if the good results observed in calm water are also present in seaway [17]. Based on his finding, Allema has reported a successful attempt in reducing the required power for a cruise ship [18].

Fridman has presented the most thorough research material available on interceptors used as a means to ventilate ship's hull bottom. He also reported the research results on a system consisting of both under-bottom-mounted and stern-mounted interceptors on cutter-class vessels. Fridman also suggested theoretical models to predict lift and drag due to the interceptors [19].

Alexander H. Day et al. carried out a comprehensive experimental tank test program on a scaled model of a yacht hull to examine the impact of interceptors. The results indicate a significant reduction in calm water resistance over a wide speed range with gains of 10 ÷ 18 % in the speed range between 8 and 20 knots, accompanied by a reduced trim and sinkage. The performance of the interceptors was also compared with Gurney flap, and in addition the effect of interceptors on trim change was compared with the longitudinally moving ballast, and as observed, the benefits appear to be largely sustained in small waves [21].

The literature review of the available results on interceptor and its application indicates that in spite of the popularity of interceptors, there have been a relatively low number of published studies comprehensively exploring the effect of interceptors on hull resistance, and apparently, the foregoing surveys were not specifically aimed at high speed planing mono-hull and catamaran resistance. Therefore, the aim of the present study is to provide a method to evaluate the effect of interceptors on high speed planing mono-hull and catamaran and fill the knowledge gap that currently exists, by carrying out the tank test of the scaled-down planing mono-hull and catamaran models with interceptors at full planing speed.

SELECTING INTERCEPTOR SIZE AND DIMENSIONS

Interceptor height

Several researchers have studied the optimal height of interceptors to maximize the interceptor effectiveness in terms of improving hydrodynamic quality of planing vessels. Most of them agree that the selection of interceptor height depends mostly upon the boundary layer thickness at interceptor location. The idea widely adopted is that the interceptors should be contained entirely within the boundary layer, so that the interceptor height is partly a fraction of the boundary layer thickness. Thus, as the initial approximation, the boundary layer near the transom (for aft interceptor location) can be considered in the same way as that over the flat plate having the same length as the hull. The thickness for the boundary layer in the turbulent flow can be calculated from Eq. (1), [22]:

$$\delta(x) = 0.37 \times \text{Re}_x^{-1/5} \quad (1)$$

Several manufacturers producing interceptor systems have put forward various suggestions for the interceptor height. Humphree suggested the interceptor height of up to 50 mm for power boats between 18 and 45 m, [25], while other manufacturers recommended a height extended to 75 mm for heavier vessels between 18 and 60 m in length.

Brizzolara used an interceptor at the maximum height of 200 mm on the steering interceptor of STENA HSS-1500 vessel of 127 m overall length and 40 kn speed [13]. Alexander H.Day et al. surveyed the literature and plotted the found interceptor height values against the Reynolds number. The mentioned author compared then the results with the boundary layer thickness values obtained from Eq.(1), [22]. The relevant figure is re-plotted in Fig. 2 with the additional data, showing non-dimensional interceptor height in relation to the boat length. Since tank tests usually cover a wide range of speeds, only several values are plotted for each study, which represent different interceptor heights and different speeds in order to put the scatter in context. Because of the fact that in the case of planing vessels the wetted length can vary substantially with speed, the static wetted length is used.

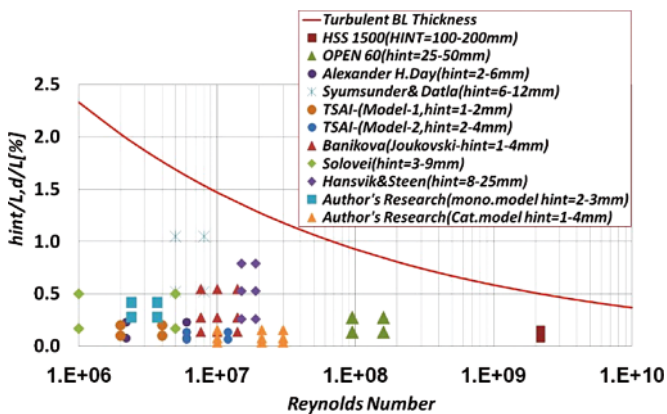

Fig. 2. Experimental data on non-dimensional height of interceptors

As depicted in Fig. 2, the selected interceptor's heights become much smaller proportionally to the boundary layer thickness. Based on the above-mentioned suggestion and as shown in Fig. 2, in the present experimental study the interceptor was tested at model-scale height of 2 to 3 mm for mono-hull model and 1 to 4 mm for catamaran model. Therefore, the non-dimensional interceptor height varies from 0.4 % to 0.6 % of the model waterline length for mono-hull model, and from 0.03 % to 0.13 % of the model waterline length for catamaran model. As Fig. 2 shows, at corresponding Reynolds numbers, the selected interceptor heights are located well within the range of the boundary layer thickness (from 13.6 % to 23.7 % of the boundary layer thickness for mono-hull model and from 2.8 % to 13.5 % of the boundary layer thickness for catamaran model, respectively).

Interceptor spans and positions

In addition to selection of interceptor height, the other important parameters for the case of the location of both stern and mid-interceptors are: span and longitudinal position of interceptors. As for the span, the full beam of the mono-hull and the half beam of each twin-hull (130 mm) of the catamaran model are used as interceptor's span. For both the models transom is considered as the location of the stern interceptor and the longitudinal position of the mid-interceptor for the catamaran model is the distance of about $3 \div 5$ % of waterline length ahead of the model's centre of gravity, [12].

CATAMARAN MODEL EXPERIMENTAL PROCEDURE

Model and model tests

The 18 m planing catamaran selected for the tank-test investigation, has V-shaped cross sections and hard chine twin-hulls. In the current study, all tank tests were performed in the KSRI high-speed towing tank of the dimensions: 650 m (L) \times 14 m (W) \times 6 m (D). Its carriage is able to travel at the speed of up to 16m/s (from 0.01 m/s up to 16m/s with 0.01 m/s step) with the speed measurement accuracy of ± 0.001 m/s. During the tests, the model was fixed against sway and yaw, while free to heave, trim and roll. The 1/6 scale model was built of wood and a special lightweight foam and formed with the use of CNC milling machine followed by special paint spraying procedures to give perfect finishing to the hull surface. The model had special windows in the bottom of each of twin-hulls for monitoring wetted surface boundary behind the mid-interceptor. The experimental procedure in general conformed to the ITTC standard procedures for model making and resistance testing [23, 24]. During the towing tests the following parameters were measured: speed of the model, total resistance of the model, dynamic trim and dynamic sinkage at the point of towing strut attachment. In addition, the boundary of hull-wetted area was also recorded at each test speed. The model's principal dimensions are given in Tab.1.

Tab.1. Model's principal dimensions

Model	Boat	Main particulars
3 m	18 m	Length overall
0.70 m	4.2 m	Beam (total)
65 Kg	14.4 t	Displacement
11.55 m/s	55 knots	Design speed
$(0.32 \div 0.38) \times L$ measured from transom	$(0.32 \div 0.38) \times L$ measured from transom	Lcg (centre-of-gravity location)
20 deg	20 deg	Dead-rise at Lcg
0.26 m	1.56 m	Twin-hull beam
0.180 m	1.08 m	Tunnel beam

Test matrix

As Fig. 1 shows, in the case of considering location of both stern and mid-interceptors, the relative position of interceptors and the boat centre of gravity will define the state of dynamic stability of the vessel, and before implementation of any control mechanism the vessel itself should be dynamically stable in terms of porpoise motion etc. Then in the present study, the optimum position of the model's centre of gravity was selected on the basis of the bare hull performance, and next the tank test was performed for the selected position of the centre of gravity and various interceptors' height values.

Performance of bare hull at different centre-of-gravity positions

The model of 65 kg in weight was tested in bare hull condition for three relative positions of centre of gravity corresponding respectively to 0.32L, 0.35L and 0.38L measured from transom ahead, over the speed range corresponding to full-scale speeds up to 60 knots. Fig. 3 and 4 show the variation of relative resistance and trim angle along with the displacement Froude number (F_{Δ}), respectively. Based on the results

a number of observations can be made: the variation of the Lcg of the model has remarkable effects on the relative resistance and trim angle over the wide range of Froude number values corresponding to the planing speeds.

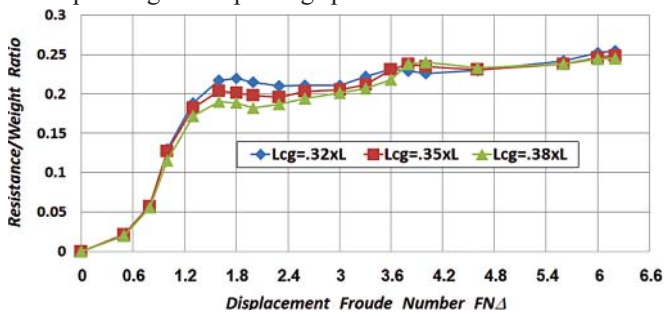

Fig. 3. Variation of relative resistance with Froude number

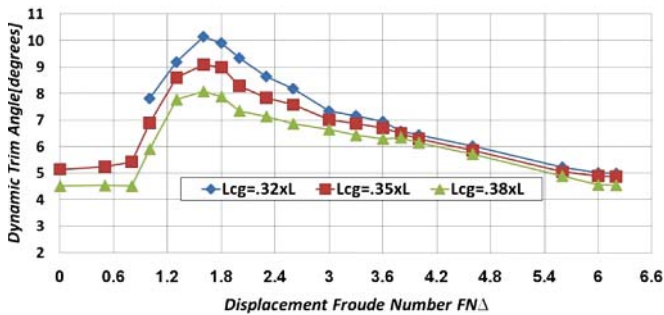

Fig. 4. Variation of running trim angle with Froude number

Tab. 2 shows the variation of the relative resistance and trim angle along with $FN\Delta$. As Tab. 2 shows, at the Froude number corresponding to the first hump ($FN\Delta = 1.5 \sim 1.8$), the shift of the Lcg up to 6 %L to the bow will give the resistance reduction up to 11 ÷ 14%.

As Fig. 3 shows the second hump is observed at $FN\Delta = 4$. At this $FN\Delta$ value which corresponds to 38 kn speed in the full scale (lower than cruising speed), the maximum resistance is observed at the $Lcg = 0.38L$ measured from transom. From $FN\Delta = 4$ up to $FN\Delta = 5.82$ (corresponding to the full scale design speed), the resistance will be decreased by shifting the Lcg to the bow. From the dynamic stability point of view, as observed during the tank test, at the relative position of the centre of gravity, corresponding to 0.32L, the model suffered porpoising instability at $FN\Delta > 6 \div 6.2$. Based on the above given results, the relative longitudinal position of the centre of gravity corresponding to 0.38L measured from transom was then selected for execution of tank test of models with interceptors.

Tab. 2. Variation of resistance and trim with $FN\Delta$

$FN\Delta$	Relative resistance reduction ratio			Relative dynamic trim reduction		
	0.32L	0.35L	0.38L	0.32L	0.35L	0.38L
$FN\Delta = 1.0$	1	0.97 (3%)	0.88 (11.5%)	1	0.88 (12%)	0.76 (24%)
First Hump $FN\Delta = 1.5 \div 1.8$	1	0.92 (8%)	0.86 (14%)	1	0.90 (10%)	0.79 (21%)
$FN\Delta = 3.0$	1	0.97 (3%)	0.95 (5%)	1	0.96 (4%)	0.90 (10%)

Test-setup for interceptor and actuator system

Resistance test in calm water is carried out not only with the fixed-height interceptors but also the selected relative position of centre of gravity ($Lcg = 0.38L$) at the model displacement of 65 kg.

The stern interceptors of the height $h_{int} = 1$ mm, $h_{int} = 2$ mm and $h_{int} = 4$ mm and the mid-interceptors of the height $h_{int} = 1$ mm and $h_{int} = 2$ mm, were tested. The stern interceptors were mounted on the transom board. The distance between the stern interceptors and the mid-interceptors was 1.3 m.

The interceptor pull-rod was inserted through an opening in the model hull and connected to a lever, with hinge axle. Another lever mounted to the same axle was connected to a lanyard attached to a foundation on the model's deck. By turning the lanyard the lever axle is caused to rotate and finally the interceptors is brought about to slide vertically along the hull side. a pointer mounted to the axle indicates the extended height of the interceptors.

Prior to each test run, the interceptor's height settings were calibrated within 0 and 6 mm. This calibration established the relation between the position of the axle-mounted pointer and the interceptor's extended heights measured vertically.

The interceptors were made of 4 mm thick Al-alloy plates. Lower edges of the plates followed the relevant portion of the hull lines. In order to reduce the friction of the movement of the interceptors, the bottom step surfaces in the way of interceptor's attachments were flush-covered with the vinyl plates. Each interceptor was secured to the respective step by two bolts. The interceptor's shapes and the attachment details are shown in Fig. 5 and Fig. 6 depicts the model hull lines.

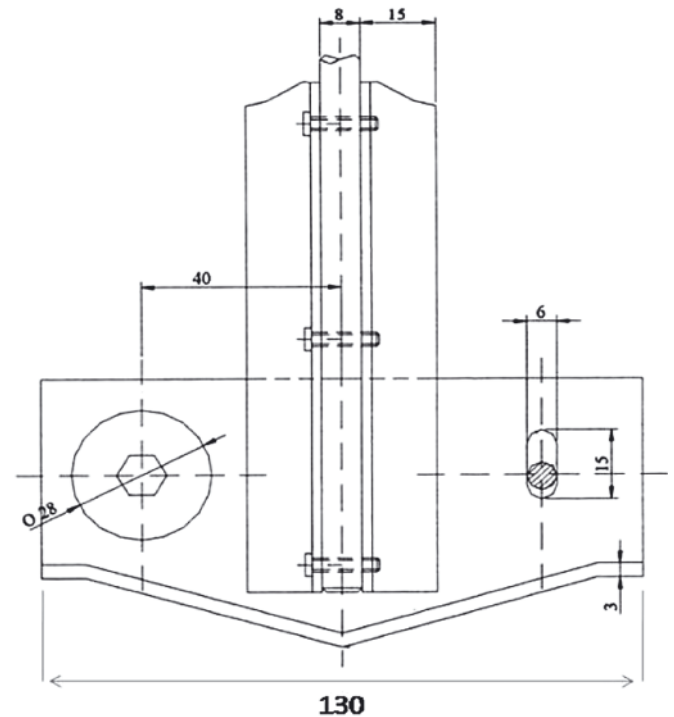

Fig. 5. Interceptor's shape and the installation details



Fig. 6. Catamaran model hull lines drawing

Results of calm-water tests with fixed-height interceptors

During the calm-water tests of the model having the displacement $\Delta = 65$ kg and centre-of-gravity location $L_{cg} = 0.38L$, the interceptors were located individually either at the middle or transom section, with various interceptor height settings simultaneously at the both sections. Testing a series of the fixed-height settings was sufficient for finding the optimum interceptor height. The test was performed for the complete speed range corresponding to the range of $FN\Delta$ up to 6.0. Measurements made during the tests were as follows: model speed, hydrodynamic resistance, and trim at towing strut attachment point. Besides, observers visually marked the foremost boundary of the portside twin-hulls wetted keel and at the chine. The information were necessary to predict the wetted area for subsequent full-scale extrapolations by using the Froude method.

Plots in Fig. 7 through 12 demonstrate the interceptor height and their configuration effects in relation to the relative resistance (R/Δ), the trim and the rise of the centre of gravity, at $FN\Delta = 1.8$ and $FN\Delta = 5.6$, corresponding to the hump and design speed of the full-scale vessel, respectively.

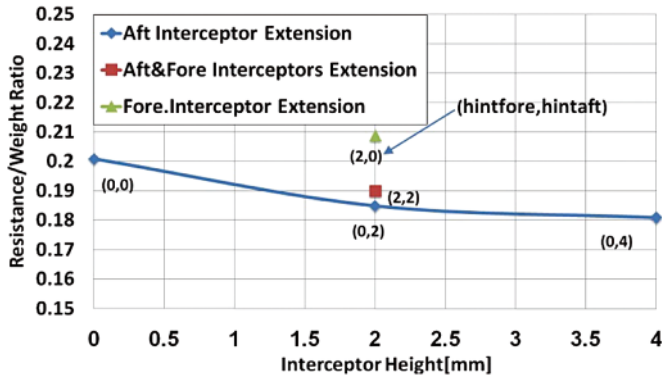

Fig. 7. Variation of the relative resistance with the interceptor height at hump speed

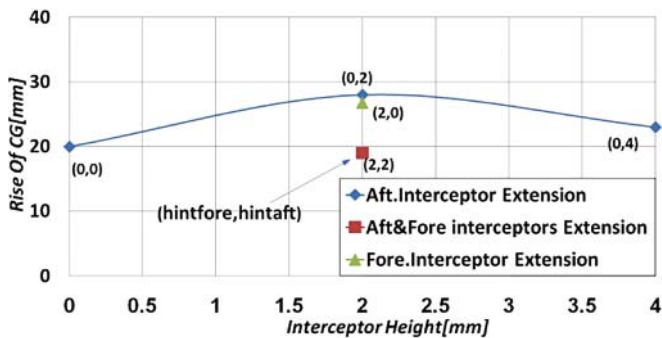

Fig. 8. Variation of the rise of the centre of gravity with the interceptor height at hump speed

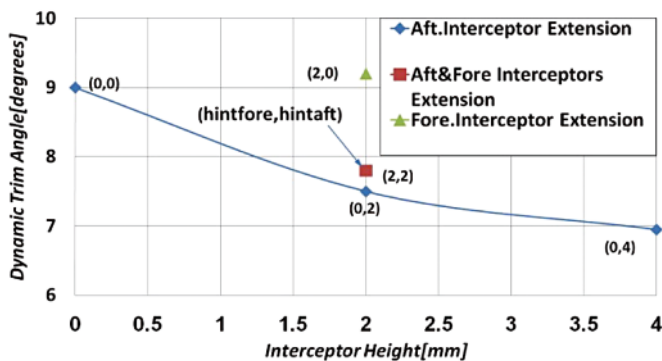

Fig. 9. Variation of the running trim with the interceptor height at hump speed

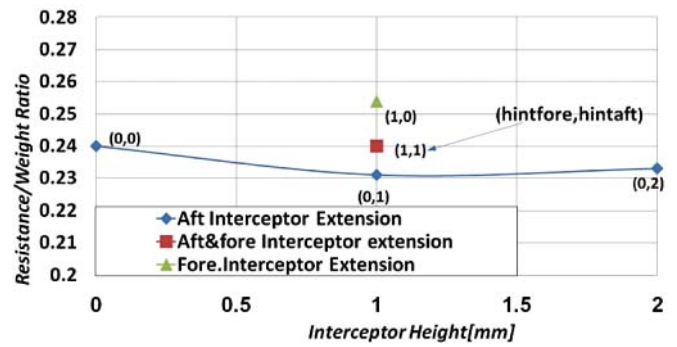

Fig. 10. Variation of the relative resistance with the interceptor height at the design speed

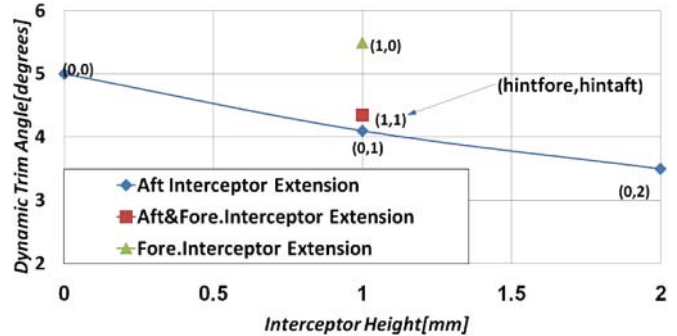

Fig. 11. Variation of the dynamic trim angle with the interceptor height at the design speed

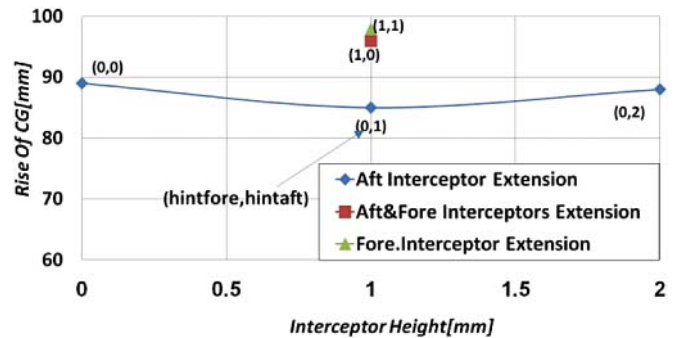

Fig. 12. Variation of the rise of the centre of gravity with the interceptor height at the design speed

A number of observations can be made based on the obtained results:

When the model runs with the hump speed ($FN\Delta = 1.8$), extending only the mid-interceptors by 2 mm (2, 0), $h/L = 0.06\%$, causes a sizeable resistance growth and the model was unable to ride faster than with $FN\Delta = 3.6$ because of the onset of intensive oscillations.

Simultaneous 2 mm extension, ($h/L = 0.06\%$), of both the mid- and stern- interceptors (2, 2) brings a certain decrease in the resistance only at $FN\Delta = 1.8$, whereas at higher speeds the resistance abruptly starts to grow.

Extending only the stern-interceptors by 2 mm (0, 2), $h/L = 0.06\%$, reduces the resistance significantly compared to riding without interceptors at low speeds. Further increasing the interceptor height to 4 mm (0, 4), $h/L = 0.13\%$, had virtually no effect on the resistance at the hump speed. In accordance with this interceptor height setting (0, 4), by increasing the speed the model trim angle and rise of centre of gravity decreased drastically.

During higher-speed tests ($FN\Delta = 4.5 \div 6.0$), interceptor height settings were varied within the range of 1 ÷ 2 mm.

Extending the interceptor height to 1 mm ($h/L = 0.03\%$) for the mid-interceptor only (1, 0), similar to the extending of

interceptors at the both sections to the same height (1, 1), results in increasing resistance at higher speeds.

Extending the interceptor height to 1mm ($h/L = 0.03\%$) at the transom only (0, 1), reduces the resistance at the moderate Froude number values, $FN_{\Delta} = 4.5 \div 5.6$.

Based on the analysis of the obtained results, the most efficient measure in terms of reducing the resistance at the hump and higher speeds was to extend the stern interceptors to 2 mm ($h/L = 0.06\%$). In some cases, the resistance reductions were as much as by $10 \div 12\%$, accompanied by noticeable reduction of trim angle. For the higher speed values ($FN_{\Delta} > 6$), extending the interceptors resulted in a sizeable resistance growth and the model became unstable (started performing intensive oscillating motions), therefore it is not advisable to use the fixed interceptors when the model rides with such high speeds.

MONO-HULL MODEL EXPERIMENTAL PROCEDURE

The 11 m planing mono-hull designed by the authors and selected for the tank-test investigations, has V-shaped cross sections and hard chine. In the present study, all tank tests were performed in the marine laboratory towing tank, Sharif University of Technology, with the dimensions of: 25 m (L) \times 2.5 m (W) \times 1.25 m (D). Its carriage is able to travel at speeds up to 6 m/s (from 0.01 m/s up to 6 m/s with 0.5 m/s step) with the speed measurement accuracy of ± 0.001 m/s. During the tests, the model was fixed against sway and yaw, and free to heave, trim and roll. The 1/15 scale model was made of wood and a special lightweight foam and formed by means of CNC milling machine, followed by special paint spraying procedures to ensure perfect finishing to the hull surfaces. The experimental procedure in general conformed to the ITTC standards, procedures for model making and resistance testing [23, 24]. During the towing tests, the following parameters were measured: speed of the model, total resistance of the model, dynamic trim and dynamic sinkage at the point of towing strut attachment. In addition, the boundary of hull-wetted area was also recorded at each test speed. Principal dimensions of the model are given in Tab. 3.

Tab. 3. Model principal dimensions

Model	Boat	Main particulars
0.73 m	11.0m	Length overall
0.16 m	2.40 m	Beam
2.02 kg	6.83 t	Displacement
5.31 m/s	40 knots	Max speed
0.35 \times Lk measured from transom	0.35 \times Lk measured from transom	Longitudinal position of centre of gravity
15 deg at transom, 18 deg at centre of gravity	15 deg at transom, 18 deg at centre of gravity	Dead-rise angle
Model initial trim = 1.25 deg Model keel wetted length (Lk) = 0.6 m Model chine wetted length (Lc) = 0.4 m Model draught at transom = 0.05 m		

Fig. 13 shows the model hull lines and Fig. 14 presents the model and related instruments in the towing tank.

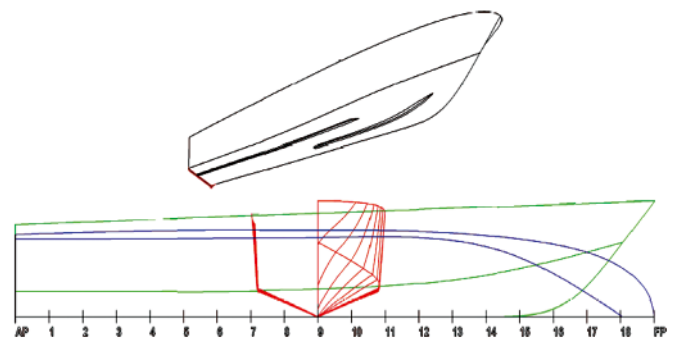

Fig. 13. Monohull model hull lines drawing

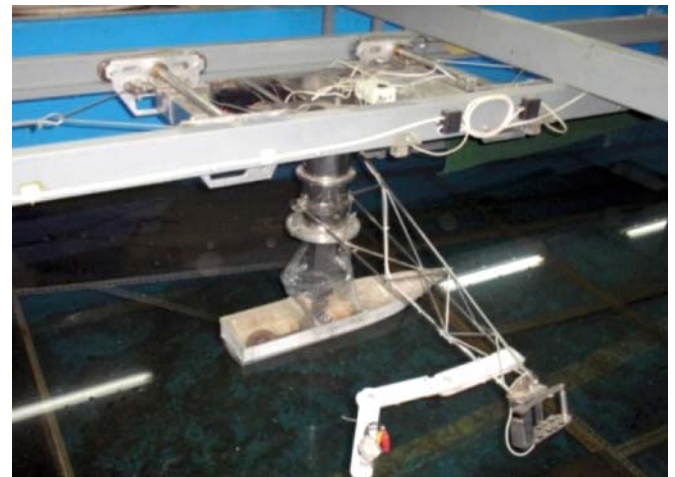

Fig. 14. Model and related instruments in towing tank

Test matrix

The model having 2 kg weight and one relative position of centre of gravity corresponding to 0.35L measured from transom, was tested in bare hull condition over a speed range corresponding to full-scale speeds of up to 45 knots. Fig. 15 and 16 show the variation of relative resistance and trim angle along with displacement Froude number, respectively. The stern interceptors of the height $h_{int} = 2$ mm and $h_{int} = 3$ mm were tested. The stern interceptors were mounted to the transom board. The interceptors were made of 4 mm thick special plastic plates attached to transom by means of a special paste.

Details of shape of the interceptor are shown in Fig. 17. Resistance test in calm water was carried out not only with fixed-height interceptors but also with the selected relative position of centre of gravity ($Lcg = 0.35L$), and the model displacement of 2 kg.

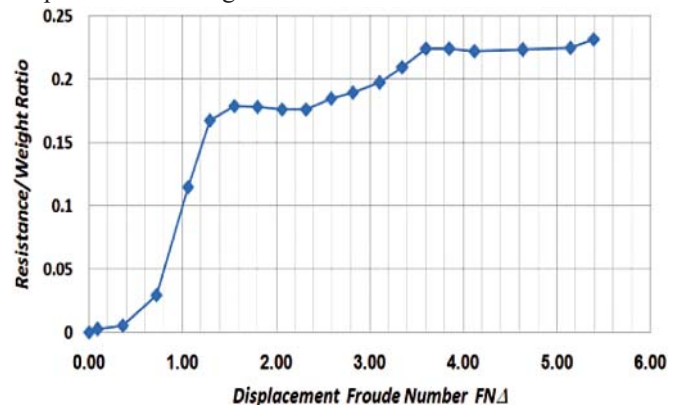

Fig. 15. Variation of the relative resistance with Froude number

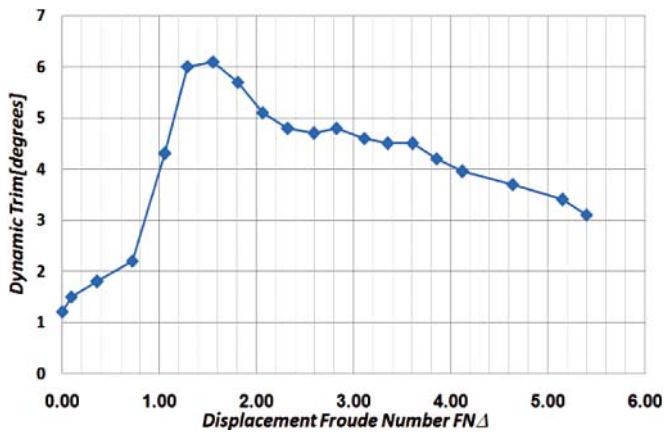

Fig. 16. Variation of dynamic trim angle with Froude number

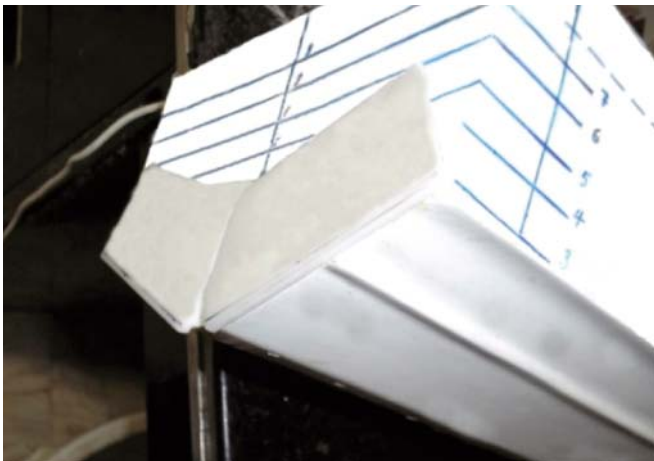

Fig. 17. Details of shape of the interceptor

Results of calm water tests with fixed-height interceptors

During the calm-water tests of the model of the displacement $\Delta = 2$ kg and the centre-of-gravity position $L_{cg} = 0.35L$, the interceptors were located at the transom section, with various height settings. The test was performed for the complete speed range corresponding to the FN_{Δ} values of up to 5.3. Measurements made during the tests were as follows: model speed, hydrodynamic resistance and trim at towing strut attachment point. Besides, observers visually marked the foremost boundary of the portside hull wetted keel and at the chine. The information was necessary to estimate the wetted area for subsequent full-scale extrapolations by using the Froude method. Plots in Fig. 18 through 21 demonstrate the interceptor height and its configuration effects in relation to the relative resistance (R/Δ) and trim at different Froude number values.

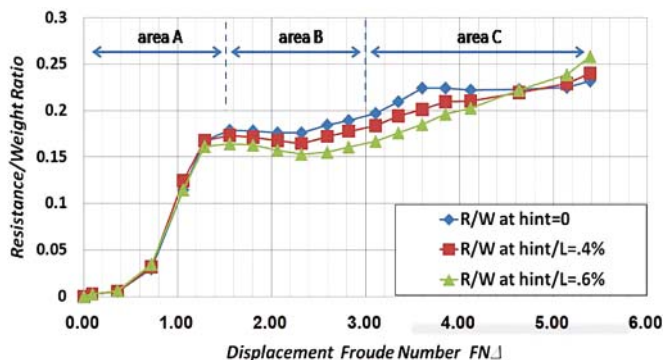

Fig. 18. Resistance test results for two interceptor's height

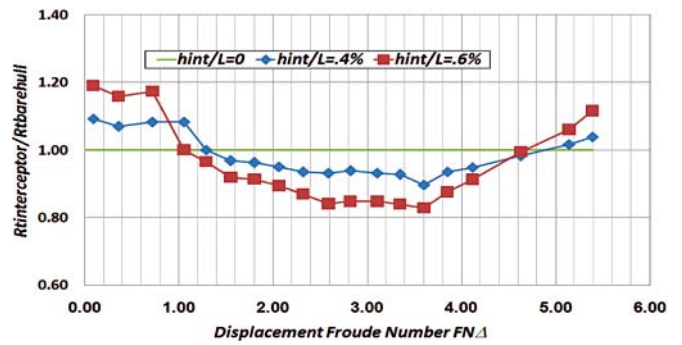

Fig. 19. Drag reduction effect due to 2 and 3mm interceptor

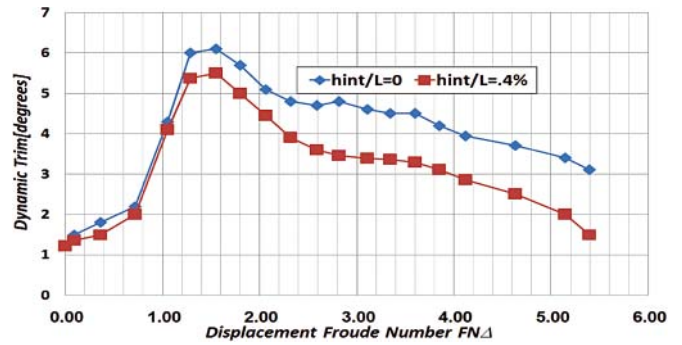

Fig. 20. Dynamic trim test results for one interceptor height

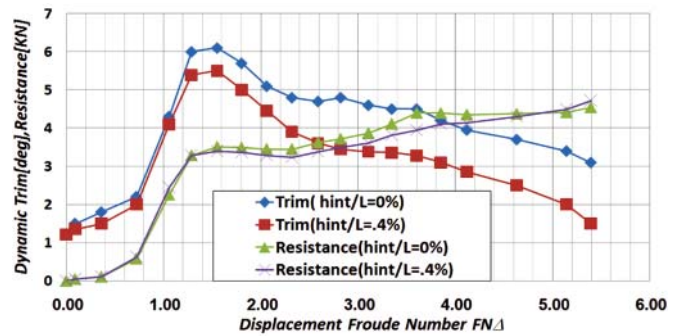

Fig. 21. Variation of the relative resistance and trim with Froude number

A number of observations can be made based on the obtained results:

Based on Fig. 15 it is found that the first resistance hump occurs at $FN_{\Delta} = 1.56$ which corresponds to the maximum running trim angle of 6 deg (Fig. 16), as Fig. 16 shows the running trim at the design speed of 40 kn ($FN_{\Delta} = 4.8$) is equal to 3.7 deg.

Fig. 18 depicts the relative resistance of the model with two different interceptor height values. Fig. 19 illustrates the drag reduction effect compared to the bare hull test results. Fig. 20 shows the effect of the interceptor on running trim. As Fig. 18 shows, the effect of the interceptor on relative resistance of the model is different in terms of Froude number. As shown in Fig. 18 three different areas correspond to various Froude number ranges; each of them can be considered in evaluating the interceptor effectiveness. When the model runs at hump speed (area A, $FN_{\Delta} = 0 \div 1.5$), extending the interceptors by 2 mm, $h/L = 0.4\%$, and 3 mm, $h/L = 0.6\%$ causes a small resistance growth resulted from low lift/drag ratio of the interceptor at such low speed values. When the model runs under transition to planing speed (area B, $1.5 < FN_{\Delta} < 3$), extending the interceptors significantly reduces the resistance compared to riding without the interceptors. Extending the interceptor by 2 mm, $h/L = 0.4\%$, reduces the resistance up to 5.2 %, and extending it by 3 mm, $h/L = 0.6\%$, lowers the resistance by 10.5 % at $FN_{\Delta} = 1.56$. When the model runs

at fully planing speed (area C, $3 < FN\Delta$), extending the interceptors still reduces the resistance of the model, but the sign of the resistance reduction in relation to the interceptor height, is changed at some Froude number depending on the interceptor height. Except that Froude number, extending the interceptor causes a sizeable resistance growth. Tab. 4 shows the percentage of resistance reduction for different interceptor height values.

Tab. 4. Resistance reduction at different interceptor height extension values

Resistance reduction percentage at $h/L = 0.6\%$	Resistance reduction percentage at $h/L = 0.4\%$	Range of $FN\Delta$
8 ÷ 11%	3.3 ÷ 5.5%	1 ÷ 2
15 ÷ 17%	7 ÷ 11%	2.5 ÷ 3.6
17 ÷ 19%	11%	3.6

Extending the interceptor at higher speeds causes a sizeable reduction in running trim, and results in a noticeable resistance growth. As Fig. 19 shows, the increase in resistance occurs at $FN\Delta = 4.7$ for interceptor extension of 3 mm, ($h/L = 6\%$) and $FN\Delta = 5.2$ for interceptor extension of 2 mm, ($h/L = 4\%$), respectively. Then at higher speeds the rate of resistance growth is increased by a rise in the interceptor height. At the design speed of 40 knots, the resistance reduction was as much as 12 % for 2 mm interceptor extension, whereas 3 mm interceptor extension results in increasing resistance. Fig. 20 shows that extending the interceptor by 2 mm, ($h/L = 4\%$) leads to a remarkable reduction in running trim. In fact, the trim reduction is about 10 % when the model rides at the hump speed and about 30 % when the model rides at the design speed.

CONCLUSIONS

The following conclusions can be obtained from the model-test results:

1. Based on the present analysis and achieved results, it is proved that the interceptors can be applied as a highly effective device to reduce the resistance of high-speed planing crafts, and in addition their performance can be improved by appropriate varying, in an integrated manner, Leg and size of the interceptors.
2. Use of the stern- and mid- interceptors can give the remarkable reduction in the resistance and running trim.
3. It is clear from the present study that for higher speeds extending the interceptors involves a sizable resistance growth.
4. As for the catamaran model, the extension of the stern interceptor by 2 mm results in some cases in the resistance reduction of up to 10 ÷ 12 %.
5. As for the mono-hull model, the extension of the stern interceptor by 2 mm results in the resistance reduction of up to 7 ÷ 11 % in some cases, and for its extension by 3 mm the resultant reduction in resistance was up to 15 ÷ 19 %.
6. Performing the experimental studies and developing the mathematical models for evaluating effectiveness of automatically controlled interceptor in calm water and in waves could be valuable future research tasks aimed at making the application of interceptors more effective in whole range of speed and loading conditions.

NOMENCLATURE

- $\delta(x)$ – Turbulent boundary layer thickness [mm]
 R_{ex} – Reynolds number at relative length position

- $h_{int}/L, h/L$ – non-dimensional interceptor height/length ratio
 d/L – non-dimensional turbulent boundary layer thickness
 R/W – resistance/weight ratio

- $FN\Delta$ – displacement Froude number $(\frac{V}{\sqrt{g\nabla}})^{1/3}$

- V – ship speed [m/s]
 ∇ – volume of displacement [m³]
 g – acceleration of gravity in [m/s²]
 Δ – boat or model displacement
 Leg – longitudinal position of centre of gravity as a fraction of boat length, measured from transom.
 h_{ints}, h – interceptor height.
 L – ship or model length.

BIBLIOGRAPHY

1. Wang C.T.: *Wedge Effect On Planing Hulls*, Journal of Hydronautics, Vol. 14, No.4, (1980).
2. Bannikov Yu.M., and Luckashevsky V.A.: *Experimental Investigation Of Lift And Drag Of Planing Plates*, TSAGI Report, Vol. 7, No.1, Moscow, Russia, (1976).
3. Bannikova T.A., Bannikov Yu.M., Luckashevsky V.A., and Zeitlin M.Yu.: *The Investigation Of The Hydrodynamic Characteristics Of The Planing Surface With a Spoiler On The Trailing Edge*, TSAGI Report No. 1908, pp.1÷22, Moscow, Russia, (1978).
4. Savitsky D.: *Hydrodynamic Design Of Planing Hulls*, Journal of Marine Technology, Vol. 1, pp.71÷95, (1964).
5. Brown P.W.: *An Experimental And Theoretical Study Of Planing Surfaces With Trim Flaps*, Stevens Institute of Technology, Davidson Laboratory Report No. 1463, (1971).
6. Savitsky D., and Brown P.W.: *Procedures For Hydrodynamic Evaluation Of Planing Hulls In Smooth and Rough Water*, Journal of Marine Technology, Vol.13, No.4, pp. 381÷400, (1976).
7. Tsai J., and Huang J.K.: *Study On The Effect Of Interceptor On High Speed Craft*, Journal of The Society of Naval Architects and Marine Engineering, Vol.22, No. 2, pp. 95÷ 101, (2003).
8. Tsai J., Hwang J., and Chou S.: *Study On The Compound Effects Of Interceptor With Stern Flap For Two Fast Monohulls With Transom Stern*, Proceedings of the 7th International Conference on Fast Sea Transportation, Fast 2003, Ischia, Italy, pp.23÷28, (2003).
9. Krylov Shipbuilding Research Institute (KSRI): *a Radically New System For High Speed Ship Motion Stabilization And Speed Increase Based on Automatically Controlled Interceptors*, KSRI Report, St.Petersburg, Russia, (2002).
10. Krylov Shipbuilding Research Institute (KSRI): *Evaluation of Effectiveness of Automatically Controlled Interceptors for Decrease of Oscillations of High Speed Catamaran*, KSRI Report, St.Petersburg, Russia, (2004).
11. Dawson D., and Blount D.: *Trim Control*, Professional Boat builder, No. 75, (2002).
12. Karimi M.H.: *Hydrodynamic Quality Improvement Techniques For High Speed Planing Crafts*, Proceeding of 7th Conference on Marine Industries, Tehran, Iran, (2006).
13. Brizzolara S.: *Hydrodynamic Analysis Of Interceptors With CFD Methods*, Proceedings of The 7th International Conference on Fast Sea Transportation, Fast 2003, Ischia, Italy, pp.49÷56, (2003).
14. Molini A., Brizzolara S.: *Hydrodynamics Of Interceptors: a Fundamental Study*, Proceeding of the International Conference on Marine Research and Transportation, ICMRT 2005, Vol.1, Ischia, Italy, (2005).
15. D. Villa., Brizzolara S.: *a Systematic CFD Analysis Of Flaps/ Interceptors Hydrodynamic Performance*, Proceeding of 10th International Conference on Fast Sea Transportation, Fast 2009, Athens, Greece, pp.1032÷1038, (2009).
16. Hansvic T., and Steen S.: *Use Of Interceptors And Stepped Hull To Improve Performance Of High Speed Planing Catamaran*,

- Proceeding of International Conference on High-Speed Craft-ACV's, WIG's and Hydrofoils, London, UK, (2006).
17. Steen S.: *Experimental Investigation Of Interceptor Performance*, Proceeding of 9th International Conference on Fast Sea Transportation, Fast 2007, Shanghai, China, pp. 237÷244, (2007).
 18. Allema J.: *Intercepting The Interceptors*, MARIN Report No. 86, pp.6÷7, (2005).
 19. Fridman G. M., Rozhdestvensky K.V., and Shlyakhtenko A.: *Theory And Practice Of Application Of The Interceptors On High Speed Ships*, Proceeding of 9th International Conference on Fast Sea Transportation, Fast 2007, Shanghai, China, pp. 214÷236, (2007).
 20. Syamsundar S., and Datla R.: *Performance Prediction Of High Speed Planing Craft With Interceptors Using a Variation Of The Savitsky Method*, Proceedings of the first Chesapeake Power Boat Symposium, Annapolis, Maryland, USA, (2008).
 21. Day A.H., and Cooper C.: *An Experimental Study Of Interceptors For Drag Reduction On High Performance Sailing Yachts*, Ocean Engineering, Vol. 38, pp.983÷994, (2011).
 22. Schlichting H.: *Boundary Layer Theory*, seventh Ed. McGraw-Hill Inc- New York, (1979).
 23. ITTC 2002.: *Model Manufacturing Ship Models*, 23rd International Towing Tank Conference, (7.5-01-01-01), pp.1÷6, Revision-01, (2002).
 24. ITTC 2002.: *Testing and Extrapolation Methods for High Speed Marine Vehicles Resistance Test*, 23rd International Towing Tank Conference, (7.5-02-05-01), pp.1÷18, Revision-01, (2002).
 25. *Interceptor Guide*, retrieved from <http://www.humphree.com/>, March 15, 2011.

CONTACT WITH THE AUTHORS

Mohammad Hosein Karimi, Ph.D. Student,
 Mohammad Saeed Seif, Prof.,
 Madjid Abbaspoor, Prof.,
 Center of Excellence in Hydrodynamics
 and Dynamics of Marine Vehicles,
 Department of Mechanical Engineering,
 Sharif University of Technology, IRAN
 e-mail: seif@sharif.edu