

Comparative study between two-level and three-level high-power low-voltage AC-DC converters

A. DOMINO*, K. ZYMMER, and M. PARCHOMIUK

Electrotechnical Institute, Warsaw, Poland

Abstract. The article presents the analysis of the simulation test results for three variants of the power electronics used as interface between the power network and superconducting magnetic energy storage (SMES) with the following parameters: power of 250 kW, current of 500 A DC and voltage of 500 V DC. Three interface topologies were analyzed: two-level AC-DC and DC-DC converters; three-level systems and mixed systems combining a three-level active rectifier and a two-level DC-DC converter. The following criteria were considered: input and output current and voltage distortions, determined as THD_i and THD_u , power losses in power electronics components; cost of the semiconductor components for each topology and total cost of the interface. Results of the analysis showed that for high-power low-voltage and high-current power electronics systems, the most advantageous solution from a technical and economical perspective is a two-level interface configuration in relation to both AC-DC and DC-DC converters.

Key words: superconducting magnetic energy storage (SMES), power electronics interface, variant solutions.

1. Introduction

Use of a multilevel configuration in medium-voltage power electronics converters may appear justified or even necessary due to the limited withstand voltage of power transistors. However, introducing three-level configurations into low-voltage converters is questionable as better voltage and current parameters are noted both at the power network input and output. Configuration of a low-voltage converter operating in a 3×400 V or similar power network depends on its application, in particular its power level [1, 9, 10, 16].

For low-power converters, i.e. those with the power of several kW that can include semiconductor components with a voltage of 600 V or less, the use of multi-level systems can be technically and economically viable. With a slight increase in the converter costs due to the higher number of semiconductor components with lower rated voltage and thus lower unit price, the voltage and current waveforms both at the converter input and output can be improved [14, 15].

The situation is different for systems with the power of several hundred kW and with transistor-diode modules of the nominal current of a thousand or more amperes whose unit price amounts to approx. PLN 1500.00. The modules are not offered for voltages below 1200 V and are compatible with two-level converters operating in 3×400 V power networks. For example, use of a 3-phase active three-level rectifier instead of a two-level rectifier will result in a significant increase in the number of semiconductor modules required (with the same or similar parameters as for the two-level system). As a result, the

total purchase cost will increase significantly, and the solution might not prove competitive. To achieve the required voltage and current quality in low-voltage high-power active rectifiers [7], it may be more economically feasible to use LC filters at the rectifier input than to introduce multi-level systems.

The article presents an evaluation of technical and economic aspects for a two-directional AC-DC-DC 250 kW (500 V, 500 A) power electronics system used as interface between superconducting magnetic energy storage (SMES) and a low or medium-voltage power network via a matching-isolation transformer [2, 8]. The interface includes a 3-phase active rectifier and a pulse DC-DC converter [6]. The comparative study described covered two-level and three-level topology (identical current, voltage and power at the system output) and a mixed topology (a three-level active rectifier and a two-level DC-DC converter) [4, 5, 12, 13]. The evaluation was based on simulation analysis of these solutions. The criteria used were as follows: cost of semiconductor components for the converters, power losses at the components and current waveform quality at the point of coupling of an active rectifier with the power network, determined as a THD_i ratio for the current and a THD_u ratio for voltage. It was also assumed that the parameters of passive interface components, i.e. filter capacitance and inductance in the AC-DC and DC-DC converter, are identical for all solutions.

2. Simulation tests

2.1. General. Simulation tests of the interface were carried out using PSIM10 software for three different topologies of the power electronics systems (item 1) used as interface between superconducting magnetic energy storage (SMES) and a power network via a matching-isolation transformer. The simulation

*e-mail: a.domino@tlen.pl

Manuscript submitted 2018-12-17, revised 2019-03-18, initially accepted for publication 2019-05-06, published in June 2019.

scheme uses models of semiconductor devices containing all the characteristic quantities and dependencies for a given semiconductor element. Thus, the THD values obtained as a result of simulation tests also contain harmonics related to switching processes of power electronics devices.

Of course, the THD coefficient contains higher harmonics.

Interface components were selected at the design stage. The following parameters of superconducting magnetic energy storage (SMES) were used:

- power – 250 kW;
- average rated current $I_{Lm(AV)} = 500$ A;
- maximum storage voltage $U_{Lm} = 500$ V;
- storage reactor inductance – $L_m = 80$ H;
- modulation at active rectifier – sinusoidal PWM at 5 kHz, providing high system efficiency and reducing switching losses in the semiconductor components while maintaining low current distortion during active power transmission between the power network and the rectifier and energy transfer at the power factor of 1, and allowing to use silicon transistors available at a unit price lower than the silicon carbide transistors;
- modulation frequency of the pulse DC regulator 5 kHz;
- regulator operation is controlled using the unipolar PWM technique, providing lower RMS current in the circuit between the capacitor in the direct current circuit and the storage (at the same energy transfer rate) than the bipolar PWM technique. It affects both the compatibility and cost of the capacitors in the DC circuit;
- the simulation tests of the interfaces used thermal simulation models of power electronics components included in PSIM10 software and model parameters as declared by the manufacturer;
- THD_i and THD_u ratios defining voltage and current quality, respectively, at the point of coupling were $\leq 3\%$.

These parameters were provided by three power electronics interfaces shown in Fig. 1, 4 and 7, with the following common components:

- Three-phase LC filter installed at the point of coupling (secondary winding of the matching isolation transformer) with the following parameters (for a single phase): $L_0 = 100 \mu H$, $C_0 = 68 \mu F$. The parameters of the passive input filter (L-C) were chosen assuming that the THD current and voltage coefficients (at the point of the power grid coupling) were less than 3% for all the analyzed solutions. Thus, the same passive filter was used for different interface configurations. The filter costs account for approx. 3% of total interface. Thus, the optimization of filter parameters for different interface configurations will not practically change the costs of interfaces, nor the power losses generated in these systems.
- Capacitive filter at the active rectifier output: $CF_1 = CF_2 = CF = 10$ mF;
- Line-to-line voltage across the secondary winding of the matching-isolation transformer provides a required 500 V DC in the energy storage supply circuit $U_{f0} = 3 \times 285$ V for the two-level and mixed configuration and $U_{f0} = 3 \times 600$ V for the three-level configuration. The voltages selected were

based on the 500 VDC voltage required at the energy storage terminals;

- For all solutions, both with the active rectifier and the step-down current regulator, dual-transistor modules were used (with opposite diodes) with the following parameters: module rated current $I_c = 1400$ A, rated voltage $U_{CES} = 1200$ V type 2MBI1400VXB-120E-50 with low power losses recommended by Fuji for use in (200 ÷ 300) kW power systems [19];
- An alternative dual-transistor module (type 2MBI900VXA-120E-50) with the following parameters: $I_c = 900$ A, $U_{CES} = 1200$ V was used in the topology with a three-level DC/DC system;
- Due to budgetary limitations and to maintain a competitive price, the interface included modules with silicon-based power electronics components and with the unit price significantly lower than for silicon carbide modules intended for use in systems with increased switching frequency, however, with higher power losses due to dynamic on-state resistance, limiting the modulation frequency to approx. 5 kHz.
- The use of SIC elements allows, among other things, for significant increase in the switching frequency of power electronics elements, which results in improved quality of voltage and current waveforms of converters. It also allows to eliminate the acoustic effects generated in magnetic elements. However, the high-current SIC devices required in the interface are many times more expensive than the corresponding silicon components. Using SiC transistors in the interface would increase the total cost of semiconductor components multiple times.

2.2. Interface simulation test results. Simulation tests were carried out at $P = 225$ kW transmitted power. Figures 1, 4 and 7

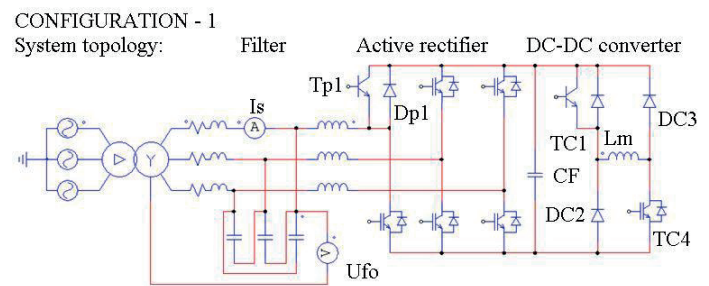
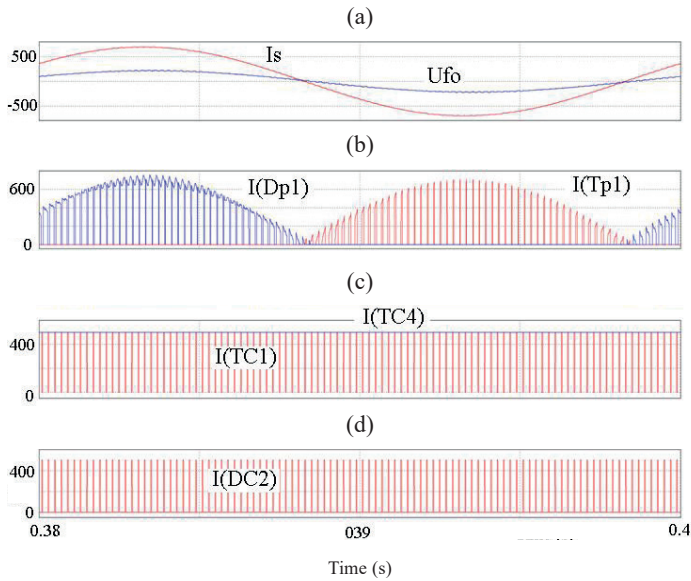

Fig. 1. Circuit configuration with two-level DC-DC converter and two-level 3-phase active rectifier

show diagrams of power electronics interfaces with two-level, three-level and mixed topology. Figures 2 and 3 show current and voltage waveforms for each semiconductor component in the two-level configuration. Figures 5 and 6 show the results for three-level configuration, and Fig. 8 and 9 show the results for mixed topology. Simulation tests were carried out for two directions of energy flow within the system.



- Two-level rectifier
- a) I_s – interface input phase current, $THD_{I_s} = 0.5\%$, U_{fo} – interface input phase voltage, $THD_{U_{fo}} = 2.56\%$,
 - b) $I(Tp1)$ – rectifier transistor current, $I(Dp1)$ – rectifier diode current,
- Two-level converter
- c) $I(TC1)$ – DC-DC converter transistor current, $I(DC2)$ – converter diode current,
 - d) $I(DC2)$ – DC-DC converter diode current.

Fig. 2. Energy flow process from the power network to the storage reactor in two-level topology

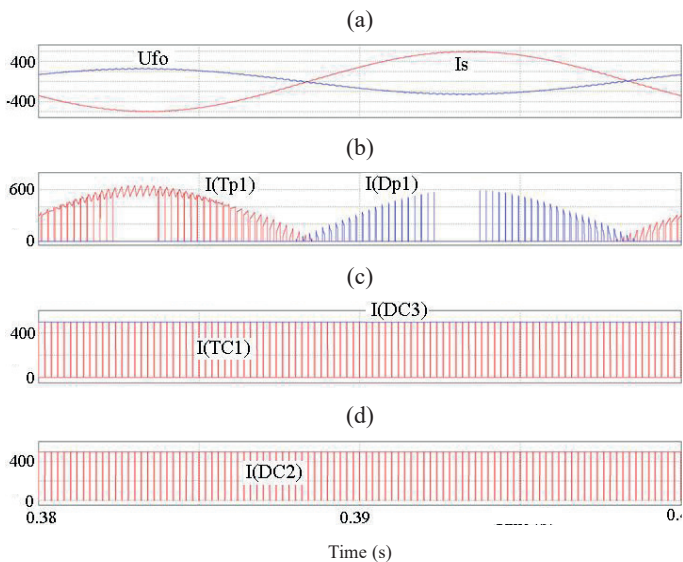

- Two-level rectifier
- a) I_s – interface input phase current, $THD_{I_s} = 0.8\%$, U_{fo} – interface input phase voltage, $THD_{U_{fo}} = 2.76\%$,
 - b) $I(Tp1)$ – rectifier transistor current, $I(Dp1)$ – rectifier diode current,
- Two-level converter
- c) $I(TC1)$ – converter transistor current, $I(DC3)$ – chopper diode current,
 - d) $I(DC2)$ – converter diode current.

Fig. 3. Energy flow from the storage reactor to the power network in two-level configuration

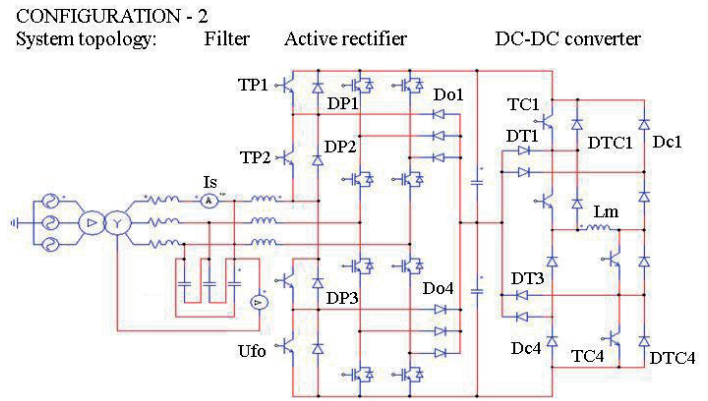
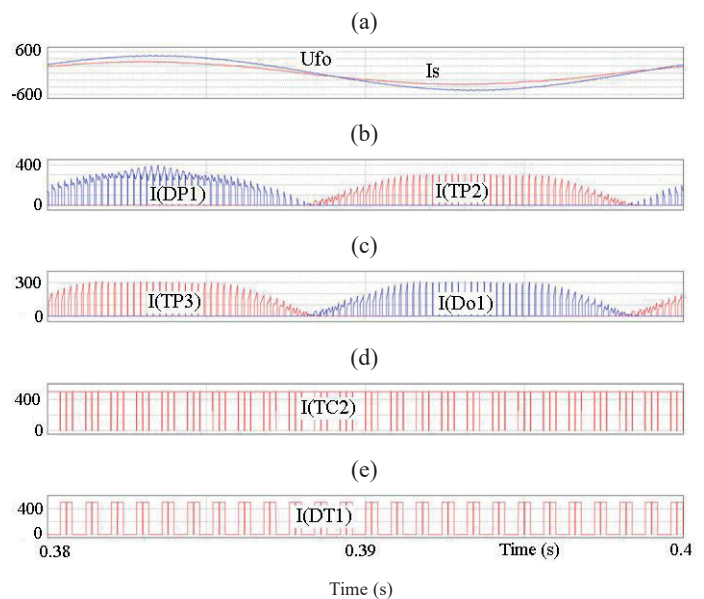

Fig. 4. System topology with three-level DC-DC converter and three-level 3-phase active rectifier



- Three-level rectifier
- a) I_s – interface input phase current, $THD_{I_s} = 1.93\%$, U_{fo} – interface input phase voltage, $THD_{U_{fo}} = 1.18\%$,
 - b) $I(Tp2)$ – rectifier transistor current, $I(Dp1)$ – rectifier diode current,
 - c) $I(Tp3)$ – rectifier transistor current, $I(Do1)$ – rectifier zero diode current,
- Three-level DC-DC converter
- d) $I(TC2)$ – converter transistor current,
 - e) $I(DT1)$ – converter zero diode current.

Fig. 5. Energy flow from the power network to the storage reactor in three-level topology

Tables 1 and 2 show the analysis results including the current and voltage in the semiconductor components of the interface along with power losses [3, 11, 17, 18] in these components for the active rectifier and DC-DC converter, respectively. The tables also show THD_i for the current at the power network input and output and THD_u for the voltage at the point of coupling with the power network. Average total power losses in the power electronics components of the interface for each

Table 1
Comparison of parameters of active rectifier components for two-level, three-level and mixed interfaces

Operating parameters of energy storage system: $L_M = 80$ H, $I_{L_M} = 500$ A, $U_{DC} = 500$ V, $f_{FAL} = 50$ Hz, $f_{DC} = 500$ A, $U_{DC} = 500$ V, $I_{L_M(AV)} = 500$ A, $P_{m(AV)} = 250/225$ kW		Two-level interface		Three-level interface		Three-level interface		Mixed interface	
Item	Component	Two-level rectifier		Three-level rectifier		Three-level rectifier		Three-level rectifier	
		Charging	Discharging	Charging	Discharging	Charging	Discharging	Charging	Discharging
1	Number of rectifier modules	3		9		9		9	
2	Module transistor peak current	709	652	310	380	310	380	708	628
3	Module transistor operating voltage	500	500	500	500	500	500	250	250
4	Module diode peak current	756	594	394	312	394	312	730	580
5	Module diode operating voltage	500	500	500	500	500	500	250	250
6	Modulation frequency	4950		4950		4950		4950	
7	THD _I for current at the power network output	0.5	0.80	1.93	2.09	1.93	2.09	1.35	1.77
8	THD _U for voltage at the rectifier input	2.56	2.76	1.18	1.29	1.18	1.29	1.15	1.41
9	IGBT module type	2MBI1400VXB-120E-50		2MBI1400VXB-120E-50		2MBI900VXA-120E-50		2MBI1400VXB-120E-50	
10	IGBT module rated current I_C	1400		1400		900		1400	
11	IGBT module rated voltage U_{CES}	1200		1200		1200		1200	
12	Module transistor average power losses	241	350	126	177	146	204	193	262
13	Module diode average power losses	350	85	129	42	139	44	264	60
14	M1, M3 module average power losses	1182	870	154	194	167	218	360	322
15	M2 module average power losses			418	219	480	248	816	474
16	Single rectifier phase average power losses	1182	870	726	632	814	714	1536	1118
17	Total rectifier average power losses	3546	2610	2178	1896	2442	2142	4608	3354
18	IGBT module cost	1450 + 800 + VAT		1450 + 800 + VAT		1290 + 800 + VAT		1450 + 800 + VAT	
19	Rectifier module cost	4350 + 2400 = 6750 + VAT		13050 + 7200 = 20250 + VAT		11610 + 7200 = 18810 + VAT		13050 + 7200 = 20250 + VAT	

Table 2. Comparison of DC-DC converter components for two-level, three-level and mixed interfaces

Item	Operating parameters of energy storage system: $L_M = 80$ H, $I_{L_M} = 500$ A, $U_{DC} = 500$ V, $f_{FAL} = 50$ Hz, $f_{M} = 500$ A, $U_{DC} = 500$ V, $I_{L_M} = 500$ A, $P_{m(AV)} = 250/225$ kW											
	Component		Two-level interface		Three-level interface		Three-level interface		Three-level interface		Mixed interface	
	Name		Charging	Discharging	Charging	Discharging	Charging	Discharging	Charging	Discharging	Charging	Discharging
20	Number of converter modules		2		6		6		6		2	
21	Module transistor peak current	A	500	500	500	500	500	500	500	500	500	
22	Module transistor operating voltage	V	500	500	500	500	500	500	500	500	500	
23	Module diode peak current	A	500	500	500	500	500	500	500	500	500	
24	Module diode operating voltage	V	500	500	500	500	500	500	500	500	500	
25	IGBT module type	Fuji	2MBI1400VXB-120E-50		2MBI1400VXB-120E-50		2MBI900VXA-120E-50		2MBI1400VXB-120E-50		2MBI1400VXB-120E-50	
26	IGBT module rated current I_C	A	1400		1400		900		1400		1400	
27	Rated voltage U_{CES}	V	1200		1200		1200		1200		1200	
28	Modulation frequency	Hz	5000		5000		5000		5000		5000	
29	Module transistor average power losses	W	1004	485	938	430	1110	514	1008	483		
30	Module diode average power losses	W	186	722	302	355	341	398	115	723		
31	M1, M6 module average power losses	W	1190	1207	735	605	855	691	1123	1206		
32	M2, M5 module average power losses	W	651	674	1016	776	1194	904	653	674		
33	M3, M4 module average power losses	W			103	355	100	398				
34	Single converter phase average power losses	W	1190	1207	1854	1736	2149	1993	1123	1206		
35	Total converter average power losses	W	1841	1881	3708	3472	4298	3986	1776	1880		
36	IGBT module + driver cost	PLN	1450 + 800 + VAT		1450 + 800 + VAT		1290 + 800 + VAT		1450 + 800 + VAT			
37	Converter module cost	PLN	2900 + 1600 = 4500 + VAT		8700 + 4800 = 13,500 + VAT		7740 + 4800 = 12,540 + VAT		2900 + 1600 = 4500 + VAT			
38	Power losses total for the interface	W	5387	4491	5886	5368	6150	6128	6384	5234		
39	Number of IGBT modules in the interface	pes.	5		15		15		11			
40	Interface modules cost	PLN	6750 + 4500 = 11 250 + VAT		20 250 + 13 500 = 33 750 + VAT		18 810 + 12 540 = 31 350 + VAT		20 250 + 4500 = 24 750 + VAT			

solution and total power losses in the semiconductor components for each solution are also shown. Total purchase costs of the power electronics components of the analyzed systems are also shown.

The analysis shows that for three-level topology of the active rectifier used in the interface, the transistor and diode currents of the power electronics module are approximately

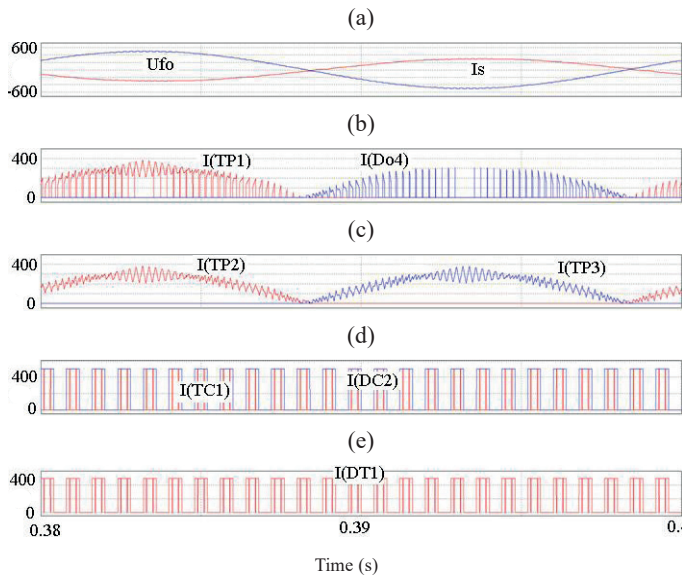

Three-level rectifier
 a) I_s – interface input phase current, $THDI_s = 2.09\%$,
 U_{fo} – interface input phase voltage, $THDU_{fo} = 1.29\%$,
 b) $I(Tp1)$ – rectifier transistor current, $I(Do4)$ – rectifier zero diode current,
 c) $I(Tp2)$ – rectifier transistor current, $I(Tp3)$ – rectifier transistor current,
 Three-level DC-DC converter
 d) $I(TC1)$ – converter transistor current, $I(DC2)$ – converter diode current,
 e) $I(DT1)$ – converter zero diode current.

Fig. 6. Energy flow from the storage reactor to the power network in three-level topology

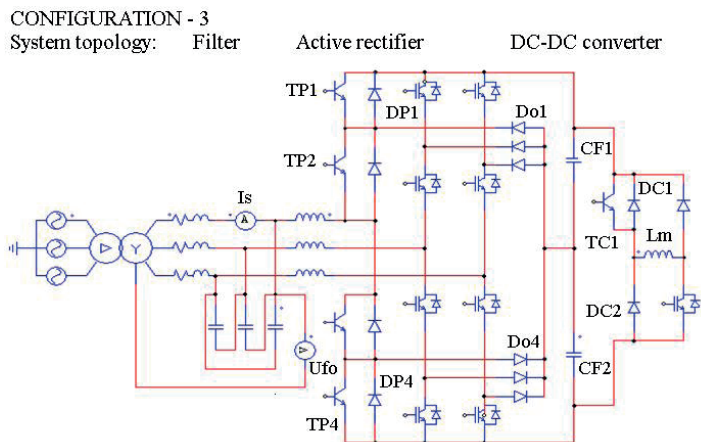
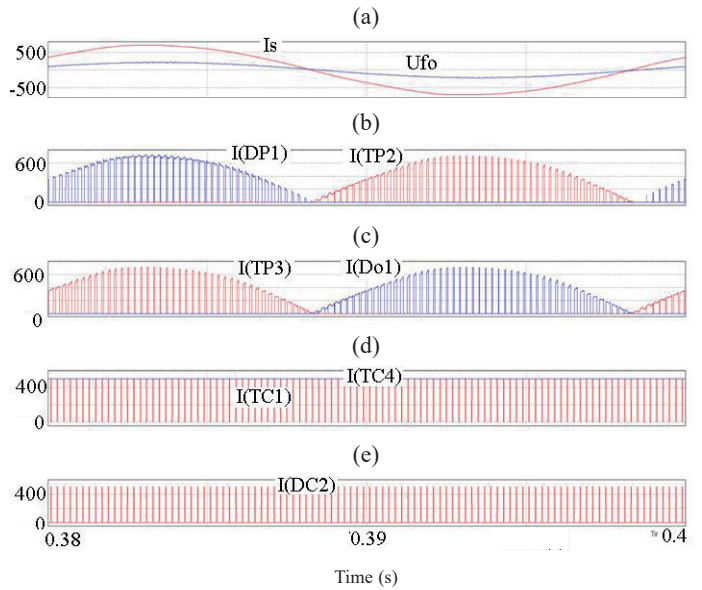
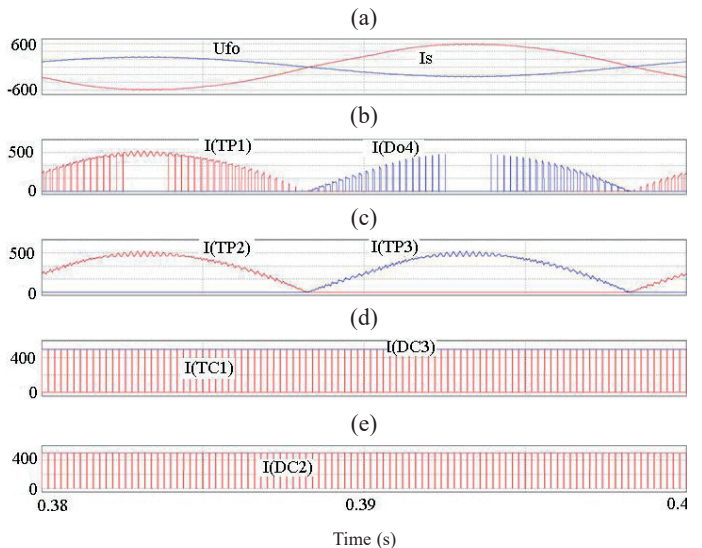

Fig. 7. Mixed configuration with two-level DC-DC converter and three-level 3-phase active rectifier



Three-level rectifier
 a) I_s – interface input phase current, $THDI_s = 1.35\%$,
 U_{fo} – interface input phase voltage, $THDU_{fo} = 1.15\%$,
 b) $I(Tp2)$ – rectifier transistor current, $I(Dp1)$ – rectifier diode current,
 c) $I(Tp3)$ – rectifier transistor current, $I(Do1)$ – rectifier zero diode current,
 Two-level DC-DC converter
 d) $I(TC1)$ – converter transistor current, $I(TC4)$ – converter transistor current,
 e) $I(DC2)$ – converter diode current.

Fig. 8. Energy flow from the power network to the storage reactor in mixed configuration



Three-level rectifier
 a) I_s – interface input phase current, $THDI_s = 1.77\%$,
 U_{fo} – interface input phase voltage, $THDU_{fo} = 1.41\%$,
 b) $I(Tp1)$ – rectifier transistor current, $I(Do4)$ – rectifier zero diode current,
 c) $I(Tp2)$ – rectifier transistor current, $I(Tp3)$ – rectifier transistor current,
 Two-level DC-DC converter
 d) $I(TC1)$ – converter transistor current, $I(DC3)$ – converter diode current,
 e) $I(DC2)$ – converter diode current.

Fig. 9. Energy flow diagram from the storage reactor to the power network in mixed topology

half as low as in a two-level configuration. Operating voltages of the components are identical for both topologies. As shown in Table 1, the transistor-diode modules with $I_c = 1400$ A and standard voltage of 1200 V were suggested for a two-level rectifier allowing for modulation frequency (approx. 5 kHz). The same components were suggested for mixed interface topology, where the transistor-diode modules of the rectifier are the same as for the two-level configuration. Operating voltages of the components in this configuration are lower by a factor of two. Since the rated voltage U_{CE} of the power transistors declared by the manufacturers is no less than 1200 V, reducing the operating voltage of the components does not allow to use components with a lower declared voltage U_{CE} , and a lower unit price. Three-level system configuration reducing the current in the semiconductor components of the rectifier by half allows to use the power electronics modules with lower current $I_c = 900$ A and voltage $U_{CE} = 1200$ V, and thus, a slightly lower unit price. The economic impact in this case is minor (Table 1).

In relation to a DC-DC converter operating with superconducting magnetic energy storage, instantaneous current and voltage of the transistor-diode modules are not affected by the interface configuration and amount to 500 A and 500 V, respectively. In a three-level configuration of the DC/DC converter, the average current of the transistor-diode module is reduced by a factor of two. Both in two-level and mixed interface topology, the transistor-diode modules with parameters identical as those used in the rectifier, i.e. $I_c = 1400$ A, $U_{CE} = 1200$ V, were used. In a configuration with a three-level DC-DC converter, analyses for a system using the transistor modules with current $I_c = 900$ A and voltage $U_{CE} = 1200$ V and a lower unit price (Table 1 and 2) were also carried out. A comparative study of the power electronics system solutions used as interface between the power network and superconducting magnetic energy storage was based on the following criteria (discussed in chapter 1):

- Higher harmonics for current THD_i and voltage THD_u determined at the point of coupling between interface and the power network or the secondary winding of the matching-isolation transformer;
- Power losses in the power electronics components of the system;
- Total price of the power electronics components used in the interface topologies discussed.

Note a) Table 1 shows THD_i and THD_u ratios. For all three configurations, a filter, limiting higher harmonics in both the input and output current and voltage at the secondary winding of the matching-isolation transformer with the following parameters: $L_0 = 100$ μ H, $C_0 = 68$ μ F, was used at the active rectifier input. THD_i and THD_u for two-level configuration with the filter, for energy flow from the power network are 0.5% and 2.56%, and in the opposite direction – 0.8% and 2.76%, respectively. Corresponding values for a three-level system are $THD_i = 1.93\%$ and 2.09%, and $THD_u = 1.18\%$ and 1.29%, and for mixed interface: $THD_i = 1.35\%$ and 1.77% and $THD_u = 1.15\%$ and 1.41%. Both for the two-level, three-level and mixed configu-

ration, THD_u and THD_i are lower than assumed by 3%, which means relatively low current and voltage distortions at the input and output of the power network.

Note b) Table 1 shows the calculation results for power losses generated by the semiconductor components of the rectifier. Table 2 shows power losses generated by the semiconductor devices of the DC/DC converter.

The power losses in a two-level active rectifier (two-level interface) for energy flow from the power network to energy storage is 3546 W, and from energy storage to the power network is 2610 W. Corresponding values for a three-level rectifier (three-level interface) are 2178 W and 1896 W, respectively. The total power losses in the two-level configuration are approximately 30% ÷ 40% higher than in the three-level rectifier. The highest power losses were observed in the semiconductor components of a three-level rectifier used with a two-level DC-DC converter, i.e. 4608 W and 3354 W, respectively.

The situation is different for power electronic components of a DC-DC converter. The values for three-level configuration are 3708 W and 3472 W, respectively, and the corresponding values for two-level configuration are approximately half as low, i.e. 1841 W and 1881 W, respectively (similar to the power losses in mixed interface.) The power losses are even higher in a three-level converter with modules characterized by lower current-carrying capacity, thus less expensive; they amount to 4298 W and 3986 W, respectively. Based on the analysis, the power losses in a two-level DC-DC converter are lower by a factor of two than in three-level configuration with identical current and voltage parameters at the system output.

The total power losses in an AC-DC converter and DC-DC converter for all discussed topologies differ by no more than 17%. For example: 5837 W (two-level configuration) to 6384 W (mixed configuration) – energy flow from the power network to energy storage and 4491 W to 5234 W (energy flow from energy storage to the power network).

Note c) Table 2 shows the costs of power electronics components for all discussed interface topologies. The lowest cost is for the power electronics components used in a system with two-level topology at PLN 11 250. The cost of power electronics components for three-level topology is PLN 33 750, i.e. three times higher. The cost is slightly lower (by approx. 8%), at PLN 31 350 for the semiconductor components with lower current-carrying capacity, yet still meeting the 250 kW power flow requirements. However, the cost of power electronics components in this solution is 2.8 times higher than for the two-level configuration. The mixed configuration requires lower investments at PLN 24 750, however, the amount is still 2.2 times higher than for the two-level configuration.

An interface with relevant parameters in a two-level configuration was built at the Electrotechnical Institute at a cost of around PLN 100 000. Taking account of the higher costs of semiconductor devices for the three-level solution, the expenditures for implementation of such interface can be estimated at about PLN 120 000, and for a mixed solution at about PLN 110 000.

3. Summary

The article presents the analysis of simulation test results for the power electronics used as interface between superconducting magnetic energy storage (SMES) and the power network with two-way electrical energy flow. The characteristic features of the interface due to the parameters of energy storage include a relatively high power (250 kW) and low operating voltage of the interface determined by the energy storage supply voltage (500 V DC). The study determined the current-voltage parameters of the device components, including semiconductor components. Analyses were carried out for three configurations of the power electronics system: two-level and three-level AC-DC and DC-DC converters and mixed topology: three-level AC-DC converter and two-level DC-DC converter. The tests were carried out assuming that the other system components, including the matching-isolation transformer power and the ripple filter at the active rectifier input, will maintain their parameters, irrespective of the system topology.

- Comparative analysis of the discussed solutions in accordance with the criteria used in the three-level system yielded THD_u lower by a factor of two, however, the calculated value of the same parameter for a two-level system was lower than the assumed value by 3%. THD_i for systems with an LC filter installed was significantly lower in a two-level system. For both configurations, THD_i was lower by 3%. Similar relationships between those parameters were observed for the mixed interface configuration.

Figure 10 shows THD_i values for three configurations, where A is the two-level configuration, B is the three-level configuration and C is the mixed configuration. Index 1 indicates charging of the energy storage reactor and index 2 indicates discharging of the reactor (the energy is returned to the power network). Figure 11 shows the comparison of THD_u for the discussed configurations.

- As regards the power loss criterion, the lowest value was observed for the two-level configuration with the value

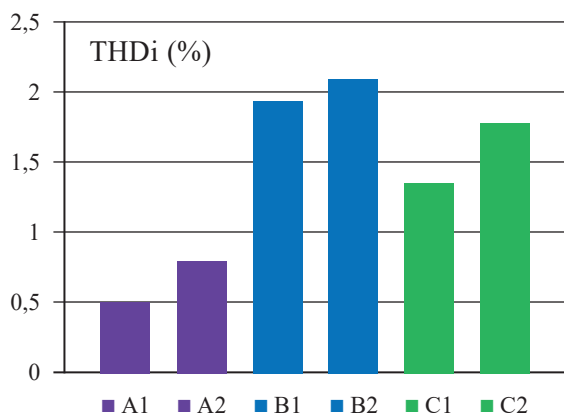

Fig. 10. Total harmonic distortion – current THD_i

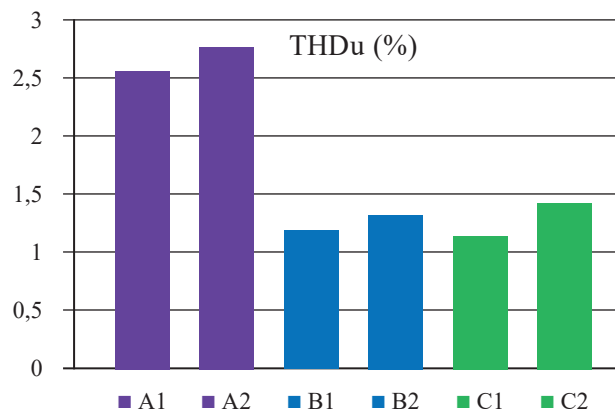

Fig. 11. Total harmonic distortion – voltage THD_u

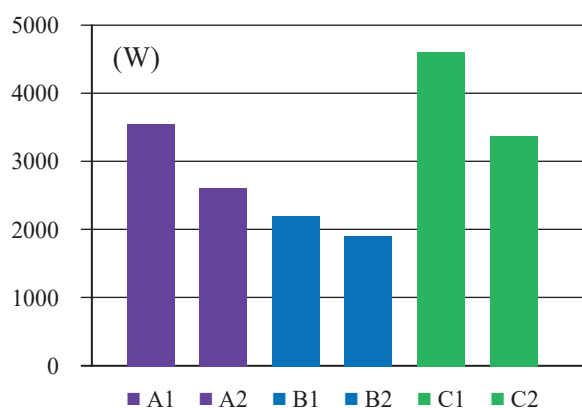

Fig. 12. Power losses in the active rectifier

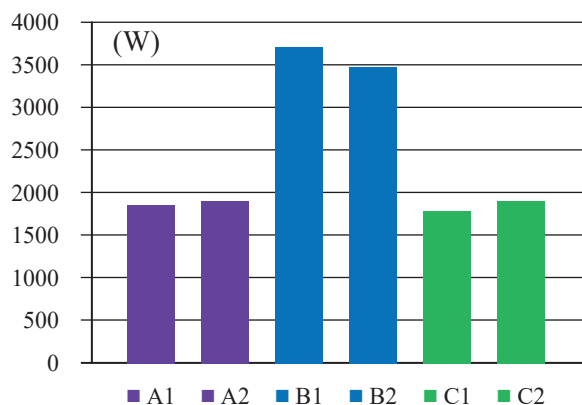

Fig. 13. Power losses in the DC-DC converter

being (10–15)% higher for the three-level and mixed configurations.

Figure 12 shows the comparison of total power losses in the semiconductor components of active rectifiers. Figure 13 shows the comparison of power losses in the semiconductor components of the DC-DC converters. Figure 14 shows the comparison of total power losses in the semiconductor components

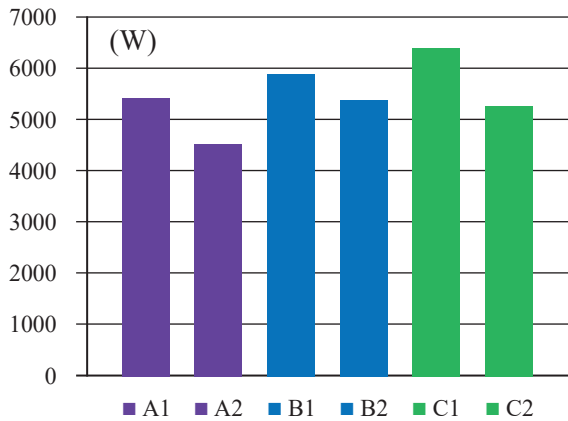

Fig. 14. Total power losses in the semiconductor components for all interface topologies

of three interface configurations. Letter and index designations indicate the same components in Fig. 10 and 11.

- As regards the cost of the power electronics components required for each configuration, the lowest costs are required to purchase the transistor-diode modules for two-level interface. Three-level interface requires three times as many transistor-diode modules, and thus the cost is three times as high. The cost can be reduced by approx. 10% by using compatible components with lower current-carrying capacity. For mixed configuration, the cost of power electronics components will be 2.2 times higher than for two-level configuration. Any increase in the cost of power electronics components will also increase the total cost of interface. The cost of three-level topology is further increased due to more complex design and advanced control system. To summarize the above, use of multi-level configuration of an AC-DC and DC-DC converter (as is the trend now) in a high-power low-voltage power electronics system is not viable from a technical and economic perspective. The required level of higher current and voltage harmonics introduced to the power network can be achieved with LC filters, already

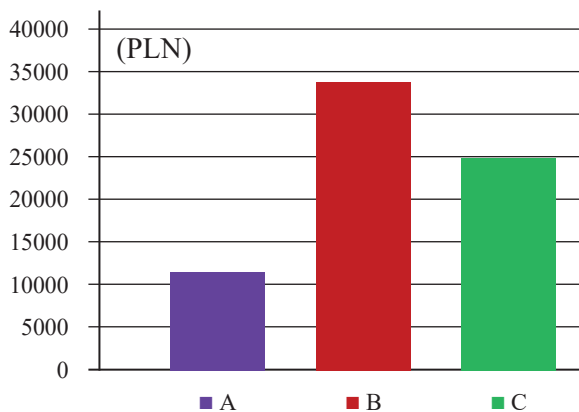

Fig. 15. Total cost of semiconductor components for all interface configurations

used in the active rectifier. A decrease in the transistor-diode module voltage by a factor of two in the mixed configuration of the interface will not have any impact from an economic point of view, since components with the current of approximately 1000 A are available for U_{CE} voltages of at least 1200 V. Also, use of components in three-level configuration with lower rated current and unit price compared to two-level configuration will not compensate for the increase in overall costs of purchase of components due to the higher number of components required in three-level configuration.

Figure 15 shows the comparison of total cost of purchase of semiconductor components and control systems for three interface configurations.

The results of the study showed that using three-level topology instead of the two-level one in the interface operating at low voltage (500 V DC), as determined by the requirements of the SMES, did not yield any improvement of the technical properties of the interface, and significantly increased the cost of the components.

Acknowledgements. The article forms part of a PBS project entitled “Superconducting magnetic energy storage with power electronics interface as used in power distribution networks”. Contract No. PBS3/A4/13/2015 of 08/06/2015.

REFERENCES

- [1] L. Bowtell and T. Ahfock, “Comparison between Unipolar and bipolar single phase grid connected inverters for PV applications”, *2007 Australasian Universities Power Engineering Conference, IEEE Conferences*.
- [2] W.K. Ham, S.W. Hwang, and J.H. Kim, “Active and reactive power control model of superconducting magnetic energy storage (SMES) for improvement of power system stability”, *J Elect Tech* 3(1), 1–7 (2008).
- [3] K.D. Papastergiou, P.W. Wheeler, and J.C. Clare, “Comparison of Losses in Multilevel Converters for Aerospace Applications”, *2008 IEEE Power Electronics Specialists Conference*.
- [4] M. Schweizer, I. Lizama, Th. Friedli, and J.W. Kolar, “Comparison of the Chip Area Usage of 2-level and 3-level Voltage Source Converter Topologies”, *IECON 2010 – 36th Annual Conference on IEEE Industrial Electronics Society*, pages 391–396.
- [5] M.H. Ali, B. Wu, and R.A. Dougal, “An Overview of SMES Applications in Power and Energy Systems”, *IEEE Trans. on Sustainable Energy*, vol. 1, no. 1, pp. 38–47, April 2010.
- [6] P.J. Grabovic, P. Delarue, P. Le Moigne, and P. Bartholomeus, “A bidirectional three-level dc-dc converter for the ultracapacitor applications”, *IEEE Trans. Ind. Elect.* 57(10), 3415–3430 (2010).
- [7] T.B. Soeiro, M. Schweizer, J. Linner, P. Ranstad, and J.W. Kolar, “Comparison of 2- and 3-level Active Filters with Enhanced Bridge-Leg Loss Distribution”. *8th International Conference on Power Electronics – ECCA, Korea 2011*.
- [8] P. Mckenna, “Superconducting Magnets for Grid-Scale Storage. Technology Review”, *Energy. March*. 2011.
- [9] G. Benysek, M.P. Kazmierkowski, J. Popczyk, and R. Strzelecki, „Power electronic systems as crucial part of Smart Grid infrastructure – a survey”, *Bull. Pol. Ac.: Tech.*, vol. 59, no. 4, 2011, pp. 445–473.

- [10] J.X. Jin and X.Y. Chen, "Study on the SMES application solutions for smart grid", *Physics Procedia*, vol. 36, pp. 902–907, 2012.
- [11] D. Sato and Jun-ichi Itoh, "Total Loss Comparison of Inverter circuit Topologies with Interior Permanent Magnet Synchronous Motor Drive System", *2013 IEEE ECCE Asia Downunder*.
- [12] Md Arifujjaman, Md Shakhawat Hossain, and M.T. Iqbal, "Efficiency Comparison of 2-level and 3-level inverter based Power Conditioning System for grid connected SOFC application", *2014 IEEE 27th Canadian Conference on Electrical and Computer Engineering (CCECE)*.
- [13] F. Chen, R. Burgos, and D. Boroyevich, "Efficiency Comparison of a Single-phase Gridinterface Bidirectional AC/DC Converter for DC Distribution Systems", *2015 IEEE Energy Conversion Congress and Exposition*.
- [14] S.O. Amrouche, D. Rekioa, and T. Rekioa, "Overview of energy storage in renewable energy systems", *2015 3rd International Renewable and Sustainable Energy Conference (IRSEC)*, pp.1–6, 2015.
- [15] M. Bartosik, W. Kamrat, M.P. Kaźmierkowski, W. Lewandowski, M. Pawlik, T. Peryt, T. Skoczowski, A. Strupczewski, and A. Szelać, "Energy storage and hydrogen economy (Magazynowanie energii elektrycznej i gospodarka wodorowa)", *Przegląd Elektrotechniczny*, 92 (12), 332–340, 2016 (in Polish).
- [16] A. Domino, K. Zymmer, and M. Parchomiuk, "Selected converter topologies for interfacing energy storages with power grid", *Bull. Pol. Ac.: Tech.*, Vol. 65 No. 5, October 2017.
- [17] K. Zymmer and A. Domino, "Wyznaczanie temperatury struktury przyrządu półprzewodnikowego w warunkach przeciążeń i zwarć", *Przegląd elektrotechniczny*, Nr 10, 2013.
- [18] P. Mazurek, K. Zymmer, J. Sikora, and A. Domino, "Wyznaczanie parametrów cieplnych przyrządów półprzewodnikowych dużej mocy metodą eksperymentalną", *Przegląd elektrotechniczny*, Nr 05, 2016.
- [19] Fuji Electric Innovating Energy Technology, "Fuji IGBT modules for solar inverter", *Bulletin of the Device Application Technology Dep.* Jan 2015.