

Article citation info:

Rośkowicz M, Godzimirski J, Jaształ M, Gąsior J. Improvement of fatigue life of riveted joints in helicopter airframes. *Eksploracja i Niezawodność – Maintenance and Reliability* 2021; 23 (1): 165–175, <http://dx.doi.org/10.17531/ein.2021.1.17>.

Improvement of fatigue life of riveted joints in helicopter airframes

Marek Rośkowicz^a, Jan Godzimirski^a, Michał Jaształ^{a*}, Jarosław Gąsior^b

Indexed by:



^aDepartment of Mechatronics, Armament and Aviation, Military University of Technology, ul. gen. Sylwestra Kaliskiego 2, 00-908 Warsaw, Poland

^bMilitary Centre for Standardization, Quality and Codification, ul. Nowowiejska 28a, 00-909 Warsaw, Poland

Highlights

- Titanium driven blind bolts improve fatigue life of repaired airframes of helicopters.
- Hybrid (rivet & adhesive) joints also increase fatigue life of repaired airframe.
- Better fatigue life for less rigid adhesive compound with thin layer of glass fabric.
- Proposed joints reduce the problem of secondary fatigue damage to the repaired airframe.

Abstract

Using original cold-formed rivets in repairs of airframes of helicopters is difficult due to no access to inside parts of the airframe. Thus, the main aim of the study was to investigate the possibility to use the blind rivets or hybrid joints by verification the fatigue performance of such joints that must be better than with original rivets. Riveted and hybrid joints have been experimentally tested under static and fatigue loads. Furthermore, numerical calculations of stress distribution for strapped joint have been conducted. The test results covered fatigue life of lap joints and models of repaired airframe sheets using ordinary mushroom head rivets ref. 3558A-4-10, titanium driven blind bolts with pin, ref. MBF2110AB-05-150 and modified hybrid joints. Using titanium driven blind bolts with pin instead of ordinary hammer-bucked rivets, can improve the fatigue life of element made of aluminum alloy AW 2024T3. There are advantages of replacing riveted joints with modified hybrid (rivet & adhesive) joints in threefold increase in fatigue life of repaired airframe structures.

Keywords

This is an open access article under the CC BY license (<https://creativecommons.org/licenses/by/4.0/>)

riveted joints; hybrid joint; fatigue life, titanium driven blind bolts with pin, ordinary mushroom head rivets.

1. Introduction

Currently, there are many aircraft in operation around the world with a service life of more than 30 years. As an example, in the Polish Air Forces there are many helicopters in operation for over 35 years (e.g. Mi-24 helicopters). Many of them have fatigue problems in the riveted joints of the structural components. The damage is in the form of loose rivets, fatigue cracks of the rivets and fatigue cracks in the joined material in the vicinity of the mounting holes [21]. Maintenance is part of operating costs which include repairs, overhauls and replacement of damaged parts. Hence, repair technologies play an important role in maintenance costs and readiness [25, 38].

Airframes of helicopters are joined together mainly with cold-formed rivets due to the materials of which they are made, i.e., aluminum alloys of the AW 2xxx group [43]. In manufacturing processes, ordinary rivets with heads of various types are usually used, made of aluminum alloys with shearing strength $R_t = 245$ MPa [40]. To a lesser extent, blind rivets are used in inaccessible sites where no bucking bar necessary in the process can be used [10,11].

Repair of damaged joints using the prescribed restorative technology solves the problem to a limited extent. The need for bilateral access to the repair node is a major constraint in the repair of semi-monocoque helicopter structures. This is particularly the case with the need for rapid repair of small-scale combat damage (bullet shot hole) which should be made in a short period of time. In-service ex-

perience indicates that there is a phenomenon of secondary fatigue damage which may occur in the repair nodes within a few months of the repair [42].

Hence, there is a need for more efficient solutions to improve the fatigue life of repair nodes. The solution may be to “shift” the sites of fatigue crack initiation beyond the critical cross-sections of the mounting holes or reduce the stress concentration factors in the vicinity of the holes. Moving the crack initiators beyond the critical zones of the rivet holes can be achieved by generating high pressure forces in the vicinity of the mounting holes. For this purpose, instead of riveted joints, bolted joints should be used, which, however, still does not solve the problem of limited two-sided access to mechanical fasteners in the assembly procedure. Thus, authors proposed that, the target can be achieved by replacing conventional rivets with a blind bolt fastener which have much higher clamping force or by using hybrid joints i.e. mechanical-adhesive joints. It is worth mentioning, that in the publications on hybrid joint solutions known to authors, nobody take into account the problem of the destruction of the adhesive joint by the pressures generated by mechanical joints during their assembly, therefore authors proposed original modification of the adhesive joints with layers of glass fabric. Nevertheless, it should be proved that the fatigue performance of such joints is at least as good with original rivets.

The problems of durability and fatigue strength of riveted joints are widely described in the literature and authors provides a brief review

(*) Corresponding author.

E-mail addresses: M. Rośkowicz - marek.roskowicz@wat.edu.pl, J. Godzimirski - jan.godzimirski@wat.edu.pl, M. Jaształ - michal.jaształ@wat.edu.pl, J. Gąsior - j.gasior@ron.mil.pl

of a literature search on this topic in next paragraph. Furthermore, authors reviewed the papers focused on the bonded repair of aluminium structures [26] and composite structures [19, 20], adhesive materials [3], fatigue strength [1,6], static strength after impact [22], environmental durability [7, 17, 23], analytical methods [8, 9] and finite element method [16, 27, 28]. In the 2017 Budhe et al. [4] issued valuable analysis covers articles published from 2009 to 2016 presenting an updated review of adhesively bonded joints. The papers described current trends regarding i.e. improving fatigue life of joints. Budhe et al. analysed main aspects over conventional joining method including mechanical fasteners and adhesive. His conclusions pointed out stress concentration as major cause of joint damage. The nowadays solution to prevent this phenomenon is to construct hybrid joints, fix with appropriate torque and filling adhesive which gradually take place in aviation [2, 5].

World literature on the repair of riveted joints is very specific. Namely, there are publications which provide dedicated solutions for specific materials of airframe and fasteners, repairs technology and geometry of structural elements of fuselage. The scientific approach to designing and assessing repairs before implementing probably started in the early 1970's [41]. Unfortunately, a large number of literature items on this subject are in the form of organizational reports or presented in conference proceedings, both having limited accessibility. Adopting repair guidelines given by the manufacturer for typical minor damages is a routine activity with many users. Procedures not listed in such repair manuals, naturally call for intervention of the scientists for detailed research on this case [18]. Thus, presented work is a response to the urgent need to develop a modern repair procedure for the aging fleet of the aircraft including Mi-24 helicopter fleet.

2. The main problems of durability and fatigue strength of riveted joints

The topic of fatigue of riveted joints is complex due to a multitude of variables related to the structure of the joint, the manufacturing process, and loading conditions during operation. The durability and fatigue strength of riveted joints is determined by the following factors, among others: quality of the surface of the rivet hole, rivet type and material of which it is made, how the rivet fits with the installation hole, potential burrs on the surface of the riveted joint, and the force with which the rivet clamps the elements together. To characterize and describe the impact of those factors, fatigue tests are conducted, initiated by Segerfröjd et al. [34].

Depending on the rivet type and rivet clamping force, fatigue cracks in the sheets to be joined can occur in various locations. There is particularly extensive literature on how rivet clamping force affects the site where cracks first occur, e.g., Hartman [14], Schijve [30], Müller

[24], Harish [13], Skorupa [36]. The sites of fatigue damage of joints for rivets with countersunk and protruding heads are the following:

- fatigue cracks are initiated and propagate in the net section (in the cross-section of the rivet center line) on the edge of the hole, where two overlapping sheets join together, Fig. 1.a;
- fatigue cracks initiate away from the rivet hole, but propagate through the hole, and they are usually slightly offset relative to the rivet center line, Fig. 1.b;
- fatigue cracks initiate above the rivet hole on the edge of the clamped area delineated by the rivet head on the sheet material, and propagate away from rivet holes, Fig. 1.c.

The initiation of fatigue cracks in the net section of the sheet on the edge of rivet hole or in the dimple under the rivet head is shown in Fig. 1a. It occurs both for rivets with countersunk and protruding heads, if the clamping force is limited and a small part of the load is transferred through friction between the sheets.

The nucleation of the crack shown in Fig. 1b. results from a modified distribution of residual stress with increased rivet head squeezing force resulting in better clamping. A significant effect of the riveting force on the moving the location where the crack is initiated away from the net section in the rivet center line is very well demonstrated in research conducted by Müller [24] and presented in Fig. 2. Notably, this type of crack initiation is largely produced by fretting (friction and corrosion wear). In assessing the effect of fretting on the initiation of cracks, we should also mention that the accumulation of the products of wear between the lapped surfaces significantly increases the friction coefficient. This has, obviously, large effect on the loads transferred by friction. For instance, in studies on fretting conducted by Szolwinski [39] for 2024-T351 alloy, the initial value of μ friction coefficient with no fretting was about 0.15. However, already after several thousands of cycles, a steep increase in that factor was observed, which was related to the formation of fretting products, until friction coefficient of 0.65 was reached. Interestingly, the growth of friction coefficient observed in the studies (Fig. 3) was consistent, both qualitatively and quantitatively, with increased friction force during fatigue studies conducted by Harman [15]. Friction between the lapped surfaces of the parts to be joined significantly contributes to the transmission of the load occurring at the joint. Experimental studies demonstrate that increasing friction force with growing number of load cycles stabilizes on a certain level and is then responsible for the transfer of 80%-90% of load by friction.

For correctly made riveting, the clamping force is very large, and fatigue cracks will initiate and further propagate above the hole (Fig. 1c). This case is also illustrated in Fig. 2 by the study results presented as points in the "above hole" area in the chart above. In this case, the load in the rivet shank - hole system is replaced by the transmission by friction between the lapped sheets. The situation described above applies to correctly make riveting with ordinary (solid) rivets, and, in particular, when rivet nuts are used with large clamping force exerted of the lapped surfaces.

In such cases, cracks occur on the sheets rubbing against each other (Fig. 1c), usually in several adjacent areas and do not propagate through the rivet hole [29, 30]. Maximum stresses accumulate in areas removed from the rivet holes, where secondary bending and fretting, acting jointly, initiate and grow the cracks.

Figure 2 also shows that the maximum fatigue stresses applied during the testing affect the crack initiation sites. For larger maximum stresses, the maximum secondary-bending torque is closer to the net section in the outlying rivet row due to limited effect of the rivet head (which restrains secondary bending), and, in addition, there are larger pressures of the rivet shank on the hole (overcoming friction forces between the joined parts), which, overall, leads to the initiation of cracks closer to the rivet hole than in the event of smaller maximum fatigue stresses.

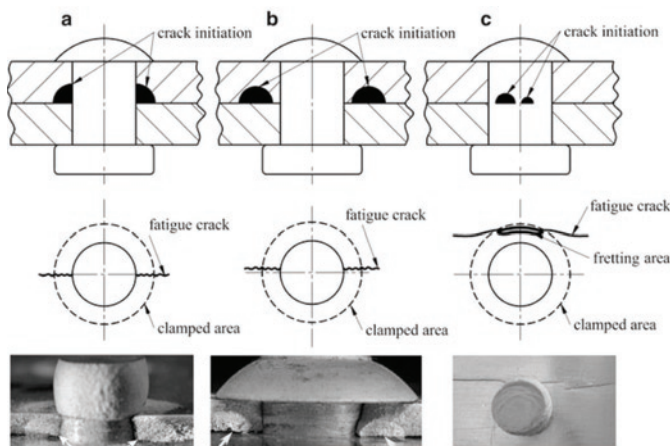

Fig. 1. Most common locations where cracks initiate in lap joints: a) on the edge of the rivet hole, b) away from the hole, c) above the rivet hole [35]

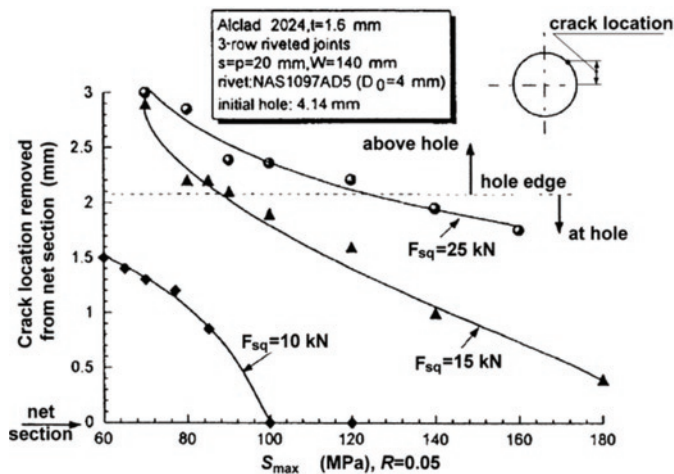

Fig. 2. Relationship between the location of cracks in lap joints and stresses for various rivet clamping forces [35]

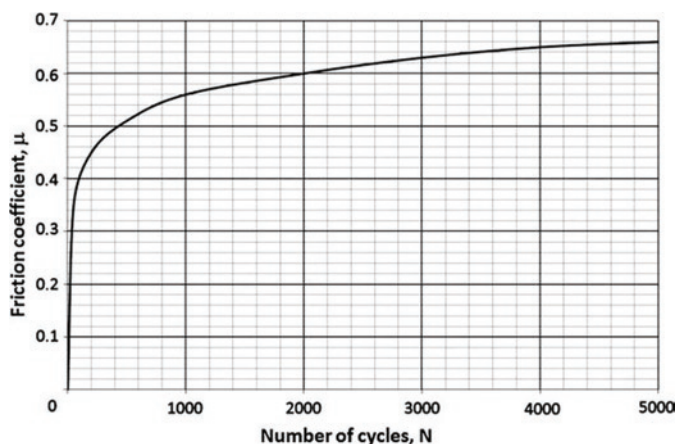

Fig. 3. Change of friction coefficient observed during fretting testing on 2024-T351 alloy [39]

Fatigue life of riveted joints can also be affected by various adhesive materials placed between the riveted parts during installation (sealers or adhesives). In such hybrid joints, cracks can initiate on sites different from those in the case of riveted joints without adhesive, and such cracks can propagate slower (as observed by Schütz [32] in testing conducted for lap joints with protruding-head rivets with and without sealers). Cracks in specimens without sealer were initiated on the edge of the rivet hole, whereas when a sealer is applied, the propagating cracks were away from the net section of the rivet row. In both cases, the external sheet of the joint was damaged, and fatigue life of the sealed joint was larger than in joints with no seal.

In analyzing fatigue life of riveted joints it is also worthwhile to note a major difference between isolated fatigue cracks and multiple cracks in riveted joints of aircraft skin. Fatigue cracks occurring in riveted joints of aircraft skin can be multiple-site damage (MSD) whose growth is determined by mutual action of the adjacent rivet holes, or single-site damage (SSD) which occurs as isolated defects mainly due to manufacturing and material defects. In terms of durability of riveted joints, multiple-site cracks are particularly hazardous for two reasons:

- Growth of MSDs from short to long is much quicker than in the case of single-site damage of the same size;
- Critical length of MSDs with the required residual strength is much less than in the case of single-site damage.

These conclusions have been reaffirmed by a number of experimental studies, for instance conducted by Schra [31] and many others [12, 37].

The purpose of the tests the results of which are presented in this paper was to find effective ways to improve fatigue life of riveted joints made in construction and repair shops in helicopters operated in the Polish Air Force for several dozen years. An improvement in fatigue life of riveted joints was achieved in two ways: one was to replace ordinary mushroom head rivets ref. 3558A-4-10 made of W65 alloy (Russian marking of aluminum alloy), 4 mm in diameter, with titanium driven blind bolts with pin, ref. MBF2110AB-05-150, with round head, diameter 4.2 mm), and the other was to use hybrid (adhesive & riveted) joints instead of riveted joints.

3. Fasteners and specimens used in experimental studies

The studies used two types of fasteners: ordinary mushroom head rivets 3558A-4-10 and driven blind bolts with pin MBF2110AB-05-150 with round head. Both rivet types have mushroom heads and require the same diameter of the hole. Ordinary rivets during the clamping expand and fill out the installation hole, but following the swaging of such rivet types, the clamp-up pressure applied to the joined elements is small. The situation is different for titanium rivets MBF2110AB-05-150 which, when clamped in place, still leave about 50 μm clearance between the shank and the hole edge and fill the hole incompletely following installation, but provide for a very large clamp-up pressure acting on the surfaces to be joined. The structure and principle of operation of such rivet types is similar to Hi-lok and Lockbolt rivets, which also ensure a significant clamp-up pressure applied to the joined surfaces. The magnitude of that pressure depends obviously on the diameter of the rivet. For instance, based on experimental studies presented in [33], the tension in the rivet shank with which the joint is clamped down has been found to be 50%-80% of the (static) tensile strength of the rivet along its shank. Hence, the Hi-Lok rivets tested in study [33] had their clamp-up pressure applied to the joint at about 5 kN, and Lockbolt rivets – about 6 kN. Unlike such fasteners, ordinary rivets are characterized by very small clamp-up pressure of the joint, i.e., within the range of 0-0.5 kN. In addition, the tested joints with rivet nuts contained significant amounts of oxides, being the products of wear (micro-friction) at crack initiation sites, which means that the crack was initiated by fretting.

The results of fatigue life testing of joints made with titanium Hi-Lok rivets have been very interesting, as their fatigue life was almost 2.5 times as much as of joints with steel Hi-Lok fasteners [33] (they differed by clamp-up pressure of the joint). In turn, joints with titanium Lockbolt rivets featured much poorer fatigue life than titanium Hi-Lok rivets despite the same configuration of the joint and rivet installation parameters. This was due to a difference in diameter between Hi-Lok rivet heads, which are about 10% larger than the diameter of Lockbolt rivet heads, which in turn affects the intensity of secondary bending in e.g. lap joints [33].

Experimental studies in this paper have been conducted on three types of specimens which differ by geometry. In addition, for each type of specimen, joints were made using ordinary mushroom head rivets 3558A-4-10 (Variant I) and driven blind bolts with pin MBF2110AB-05-150 (Variant II). The following types of specimens were used in the tests:

- single-lap joint made of two plated duralumin sheets AW 2024T3 2 mm thick and sized 100x25 mm (long x wide) fastened with either two ordinary rivets 3558A-4-10 (Variant I) or two titanium blind rivets MBF2110AB-05-150 with round head (Variant II) – Fig. 4;
- single-lap joint made of two non-plated duralumin sheets AW 2024T3 2 mm thick and sized 110x50 mm (long x wide) fastened with either six ordinary rivets 3558A-4-10 (Variant I) or six titanium rivets MBF2110AB-05-150 with round head (Variant II) – Fig. 5;
- strapped joint – repair of damaged part made of AW 2024T3 alloy 2 mm thick and sized 210x80 mm (long x wide) made by a strap

with an insert, damage in the form of a hole with diameter of 20 mm (Fig. 7), repair in the form of a riveted strip 70 mm in diameter with insert 20 mm in diameter (a round insert connected with a rivet with a patch is used in repairing airframe covers in order to reduce hole deformation; the patch and insert made of sheet AW2024T3); part were fastened with ordinary rivets 3558A-4-10 (Variant I) or titanium rivets MBF2110AB-05-150 (Variant II) – Fig. 6.

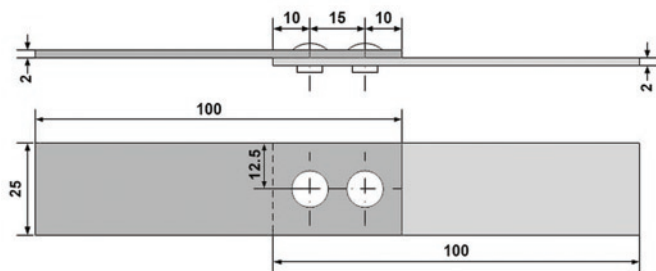

Fig. 4. Diagram of a single-lap specimen with two fasteners

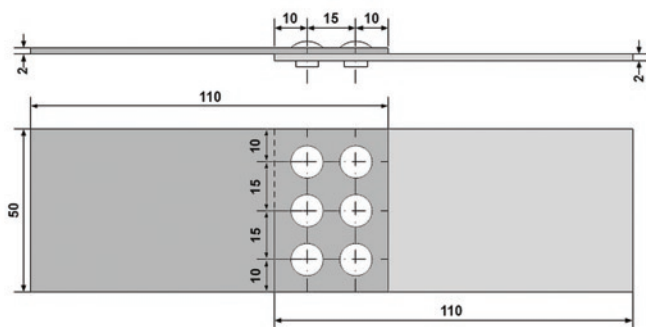

Fig. 5. Diagram of a single-lap specimen with six fasteners

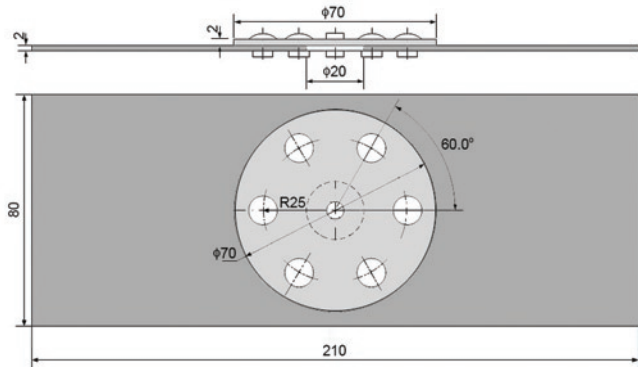

Fig. 6. Diagram of strapped-joint specimen – repair of damage

Hybrid joints were prepared based on strapped-joint specimens, using two types of adhesive material: Epidian 57/Z1 Sarzyna by Ciech S.A. (Poland) and Raychem S1125 by Cheney Manor Industrial Estate (UK). The materials used here differed significantly in terms of flexibility. Epidian 57/Z1 is a rigid material, while Raychem S1125 is a flexible material with high viscoelasticity. Stress-strain curves for these materials are presented in Fig. 7.

The surfaces to be adhesively bonded were cleaned with a 3M 3809 Fine one-sided abrasive sponge, washed with extraction gasoline and dried before applying the adhesive. Hybrid joints were made by installing fasteners prior to curing. The researchers expected that the adhesive bond with titanium rivets MBF2110AB-05-150 might be

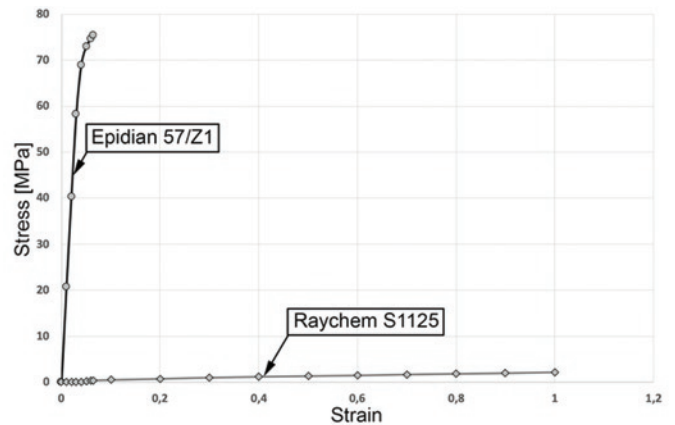

Fig. 7. Stress-strain curves for adhesive materials (speed 2mm/min)

weaker due to its high clamping force which would squeeze out the adhesive from the space between two parts to be joined. Therefore, specimens were also prepared in which a single layer of glass fabric Synglass E81 with basis weight of 101 g/m² was inserted between the parts to be joined. The bonds made with Epidian 57/Z1 were cured in two steps, i.e., for 12 hours at room temperature (about 20°C) and for 6 hours at 80°C, and Raychem bonds were cured for seven days at room temperature. The strength and durability testing was conducted on Instron 8802 machine.

4. Lap joints – results of experimental studies

Lap joints have been tested under static loads and fatigue life ranges. The following results were obtained for static tests:

- load capacity of single lap specimens fastened with two ordinary rivets 3558A-4-10 (Variant I) was 7500±200 N, and with two rivets MBF2110AB-05-150 (Variant II) it was 10,500±150 N;
- load capacity of single lap specimens fastened with six ordinary rivets 3558A-4-10 was 23,000±180 N, and with six rivets MBF2110AB-05-150 it was 31,200±150 N.

The load capacity was proportional to the quantity of fasteners used in the joint. Hence, for joints made with titanium rivets MBF2110AB-05-150 it was about 40% larger than for joints with 3558A-4-10 rivets, which was also due to the materials of which the fasteners are made (rivets 3558A-4-10 – aluminum alloy, rivets MBF2110AB-05-150 – titanium alloy and steel pin). Joints made with 3558A-4-10 rivets were damaged by shearing, and the joints with MBF2110AB-05-150 fasteners were damaged by breaking fastener heads. As a result of surface stresses occurring in joints with titanium bolts, significant ovalization of installation holes was noted.

In preparation for fatigue life testing of the above-mentioned specimens, also the boundary load values of the fatigue cycles needed to be determined. Maximum loads were selected by applying the rule that nominal stresses in sections with or without holes should be about 230 MPa, which is the upper yield strength of duralumin AW 2024T3 divided by safety factor used in aviation, i.e., n=1.5. The value of the safety factor comes from the provisions of JAR 25.303. Guided by such rule, single-lap specimens joined together with two fasteners were fatigue-loaded between the minimum force $F_{min} = 3500$ N and the maximum force $F_{max} = 5000$ N in sinusoidal cycles with 20 Hz frequency. The results of fatigue tests for five specimens with rivets

Table 1. Number of cycles to damage of a single-lap joint fastened with two ordinary rivets 3558A-4-10

	Specimen 1	Specimen 2	Specimen 3	Specimen 4	Specimen 5
Number of cycles to joint damage	551,746	714,441	464,999	602,610	626,371
Average number of cycles to joint damage	592,033				

Table 2. Number of cycles to damage of a single-lap joint fastened with two titanium rivets MBF2110AB-05-150

	Specimen 1	Specimen 2	Specimen 3	Specimen 4	Specimen 5
Number of cycles to joint damage	1,010,888	1,063,639	1,100,000 test broken	1,005,000 test broken	1,005,000 test broken
Average number of cycles to joint damage	1,036,905				

3558A-4-10 are specified in Table 1, and with MBF2110AB-05-150 fasteners in Table 2.

For three specimens of joints with titanium fasteners MBF2110AB-05-150, testing was interrupted after about 1,000,000 cycles, because qualitative confirmation has been obtained that confirms higher fatigue life of joints with titanium rivets. A view of the joints damaged during the fatigue test for two types of fasteners is presented in Fig. 8.

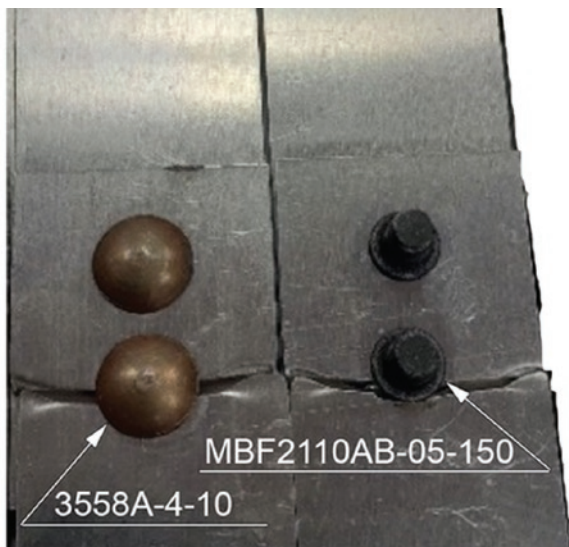

Fig. 8. View of lap joint damage for two types of fasteners (3558A-4-10 and MBF2110AB-05-150)

In addition, one of the specimens of the lap joint with two titanium fasteners which was not damaged, was studied with computer-assisted tomograph v/tome/x m, by GE, equipped with panel detector, and projection system using a cone-shaped x-ray beam (Fig. 9). An image of the joint shows that the hole is not filled out by the shank completely, which is characteristic of such fasteners.

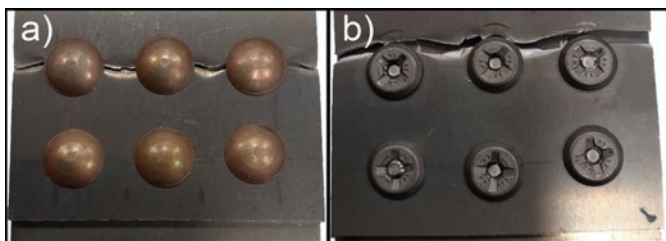

Fig. 9. CT image of a joint made with titanium blind bolts following a load of 1,100,000 cycles

On the next stage of durability studies, single-lap specimens joined together with six ordinary rivets 3558A-4-10 or titanium rivets MBF2110AB-05-150 were tested. The joints were loaded with sinusoidal fatigue cycle in the range between $F_{max}=15,000$ N and $F_{min}=10,500$ N with frequency of 20 Hz, until the sheets were damaged. The specimen with fasteners 3558A-4-10 was damaged following 207,952

cycles, whereas the specimen with fasteners MBF2110AB-05-150 was damaged following 1,140,700 cycles. The nature of the joint damage also depended on the type of fastener, i.e., for 3558A-4-10 fasteners the fracture was along the line of holes under rivet heads (Fig. 10a), and for MBF2110AB-05-150 fasteners the fracture was along the edge of heads, away from the critical section (Fig. 10b).

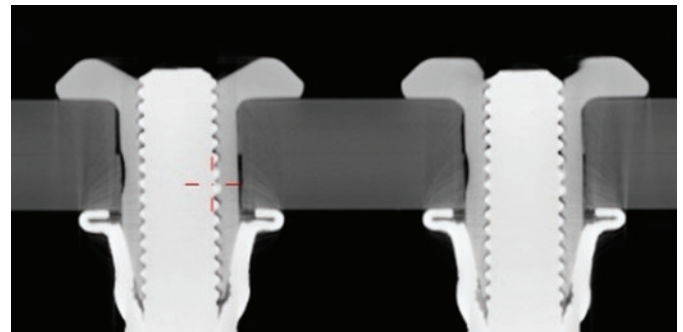

Fig. 10. Fatigue crack of sheets fastened with six rivets: (a) 3558A-4-10, (b) MBF2110AB-05-150

The durability tests demonstrated better fatigue life of joints made with titanium rivets MBF2110AB-05-150 and a different nature of damage – the crack did not follow through the weakest section but began on the edge of a head. Consistently with the current state of knowledge and the results of studies presented in global literature [13,14,24,29,30,35], cracks in joints with MBF2110AB-05-150 rivets initiated away from the critical section (as well as away from the clamped area) due to high clamp-up pressures applied to the sheets by the fasteners. For 3558A-4-10 rivets, the rivet clamping force is relatively small, due to which the load is transferred mainly by rivet shanks pressing against the surface of installation holes. In such case, cracks are initiated usually on hole edges.

5. Strapped joints (repair of damage) – numerical calculations

In strapped specimens, a problem might occur of multiple cracks due to the interference between the installation holes and the adjacent central hole having 20 mm in diameter. That is why numerical calculations were conducted on the initial stage of the analysis to assess this condition.

The calculations were conducted using the Static Structural module of ANSYS v.19.2. software. A damaged specimen was modelled (a hole 20 mm in diameter) and a specimen repaired by riveting down a metal strap (hole 20 mm in diameter and installation holes). The following boundary conditions were adopted: force of $F=30,000$ N is applied to the lateral surface as presented in Fig. 11 (the value of the force results from the adopted criterion of nominal stresses in a section with a hole at approx. 230 MPa), and the opposite lateral surface is fixed, also as shown in Fig. 11. The FE model was built based on hexagon elements (using a “Hex Dominant Method”) using tools for grid thickening in the region of expected large stress gradients. Due to the fact that the results of numerical analyses were meant to be qualitative rather than quantitative ones, the FE model was built using automatic algorithms offered by the ANSYS software.

The material of the AW 2024T3 sheet was modelled as elastic and plastic material with strain hardening (yield strength $R_e=330$ MPa, strain hardening modulus of 1000 MPa), because in calculations for the linear model of the material, stresses significantly exceeding the strength of tested material were found. Distribution of Huber-Mises reduced stresses and maximum principal stress, which characterize better the strain of the material in fatigue tests. First, calculations

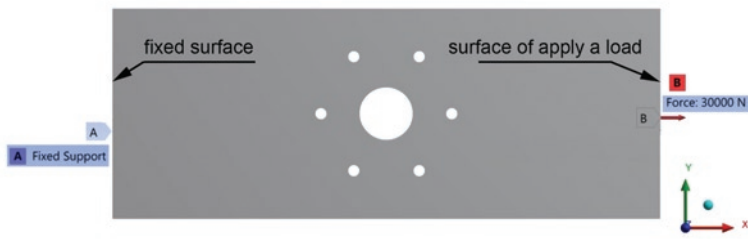

Fig. 11. Boundary conditions of the model under analysis

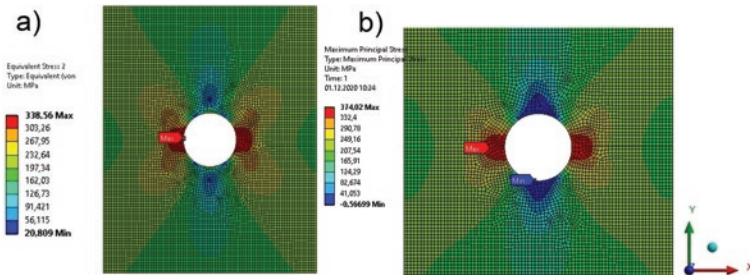

Fig. 12. Distribution of stress in a part with 20 mm hole loaded with 30,000 N: (a) Huber-Mises stresses, (b) maximum principal stress

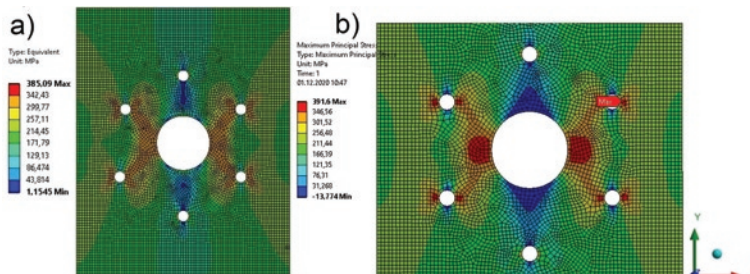

Fig. 13. Distribution of stress in a piece with 20 mm hole and installation holes 4.2 mm in diameter loaded with 30,000 N: (a) Huber-Mises stresses, (b) maximum principal stress

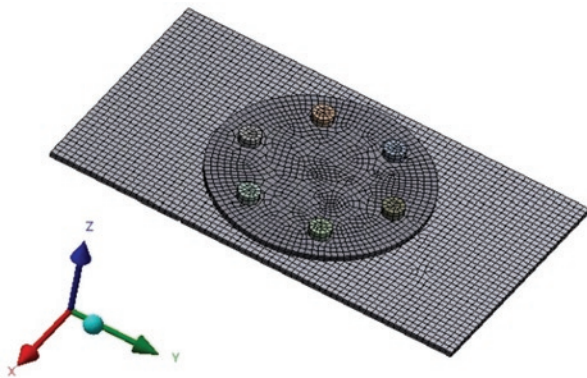

Fig. 14. Numerical model of strapped joint of a specimen with riveted patch

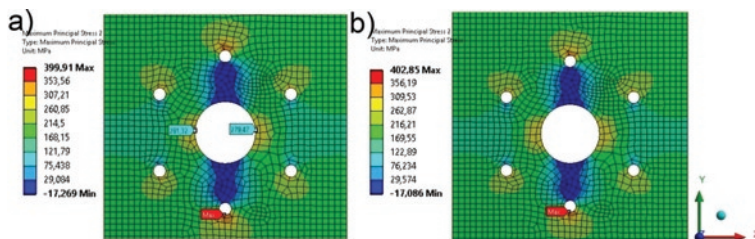

Fig. 15. Distribution of maximum principal stresses in a piece repaired with: (a) titanium rivets, (b) duralumin rivets

were conducted for the distribution of reduced stresses by Huber/Mises hypothesis (Fig. 12a), maximum principal stress (Fig. 12b), in a piece with a single hole 20 mm in diameter, loaded with 30,000 N. For the part with hole $d = 20$ mm with the load of 30 kN it was found that the yield strength of the material AW 2024T3 in its critical section was exceeded.

In the next step, calculations were conducted for the distribution of reduced stresses by Huber/Mises hypothesis (Fig. 13a), maximum principal stress (Fig. 13b), in a piece with a central hole 20 mm in diameter and six riveting holes, loaded with 30,000 N.

In the piece with installation holes $d=4.2$ mm, maximum stresses at load of 30,000 N are by about 50 MPa more than in the piece with a single central hole only. Consequently, the specimen with the 20 mm hole should feature, among other things, better fatigue life than the specimen with rivet holes. Upon obtaining the results for the model of a plate with a central hole and rivet holes, model specimens were developed with a round strap of 70 mm in diameter mounted on the damaged part using duralumin rivets and titanium rivets (Fig. 14). Models of joints with titanium and duralumin rivets were developed with the assumption that the damaged part and the strap are made of aluminum alloy modelled as bilinear material with yield strength of $\sigma_y=330$ MPa and strain hardening modulus $D=1000$ MPa; linear properties of the rivet material (aluminum and titanium, respectively) were adopted. Boundary conditions for load and strain hardening were adopted identical to the previous model. In addition, friction factor at $\mu=0.1$ was assumed between rivet heads and joined elements and between the strap and the damaged part. The rivet shanks were also assumed to fill in the rivet holes without friction and fit the sheet material subject to deformation ("no separation" function built into Ansys was used). The initial analyses of rivet joints covered cases meant to be only a point of reference for further analysis, and namely, they assumed that both duralumin and titanium rivets do not clamp together the sheets to be joined, and the entire load is transferred by friction force and by shearing of rivet shanks. Distribution of stresses in the damaged part using various fasteners are presented in Fig. 15.

It was found that if clamping forces in the parts to be joined produced by the installed rivets and the bucking of the shanks of duralumin rivets are not taken into account, the most loaded during the transfer of joint loads are the external rivet holes (Fig. 15), which is not reaffirmed by experimental studies where duralumin and titanium rivets are clamped together with an appropriate force.

Finally, specimen model was developed with a strap installed on the damaged part using duralumin rivets and titanium rivets, taking into account clamp-up pressures in the parts to be joined, generated by the installation of rivets as well as stresses occurring in the hole due to the bucking of duralumin rivets. Models of specimens with titanium and duralumin rivets were developed with the assumption that the damaged part and the strap are made of aluminum alloy modelled as bilinear material with yield strength of $\sigma_y=330$ MPa, with linear properties of the rivet material (aluminum and titanium, respectively) defined. In addition, friction factor at $\mu=0.1$ was assumed between rivet heads and the element and between the strap and the damaged part. Rivet shanks were also assumed to fill in the rivet holes without friction and fit the sheet material subject to deformation ("adjust to touch" function built into Ansys was used). Duralumin rivets were also assumed to clamp down the element with 500 N, and expanding rivet shanks press down on the internal surface of the holes, defined as pressure of 150 MPa. Titanium rivets clamp down the sheets with 5 kN and fill out the rivet holes without pressing down on the surface (due to no expansion inside the hole). Boundary conditions for load and strain hardening were adopted identical to the previous model. The clamping down of

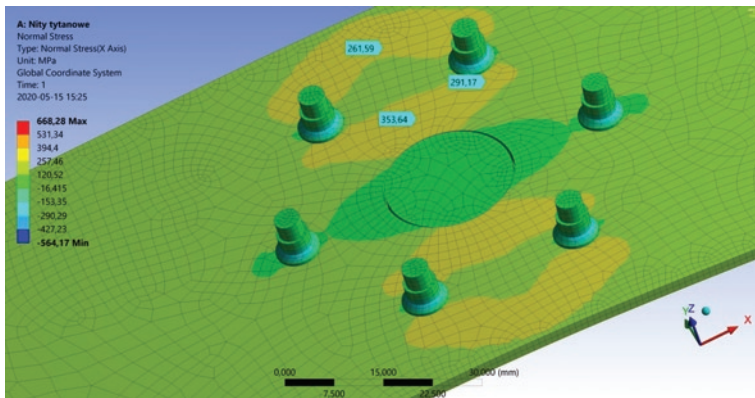

Fig. 16. Model of a specimen with titanium rivets and distribution of normal stresses along a piece straining load

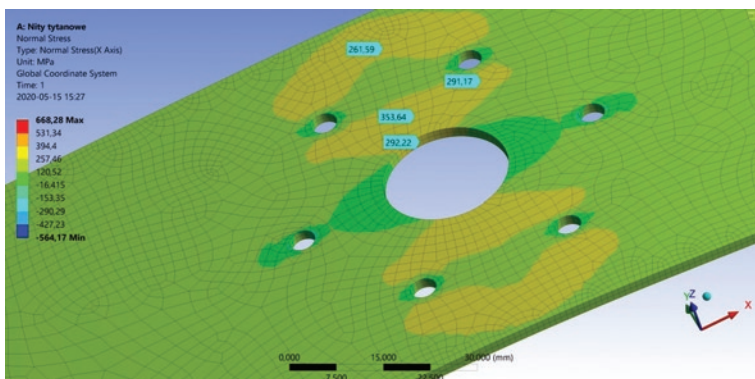

Fig. 17. Model of a specimen with hidden titanium rivets to facilitate the imaging of the distribution of normal stresses in rivet hole areas

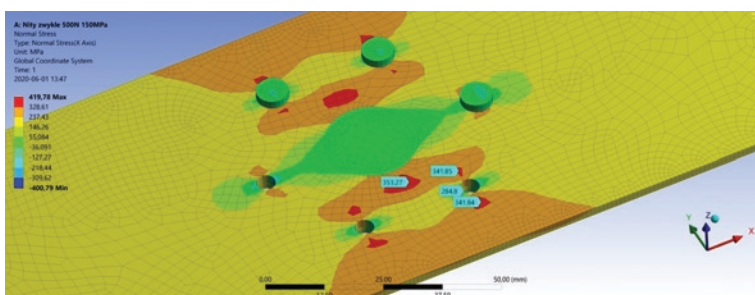

Fig. 18. Distribution of stresses in an element being repaired using expanded duralumin rivets

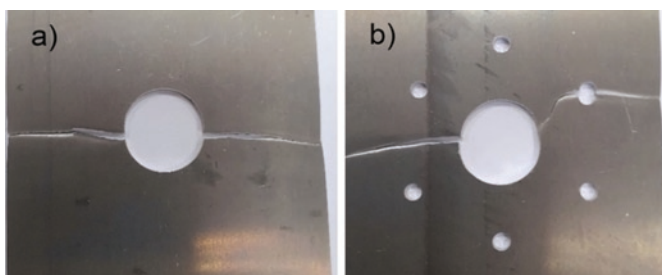

Fig. 19. Fatigue damage of a WA 2024T3 alloy part 2 mm thick and with the size of 210x80 mm: (a) with a hole 20 mm in diameter; (b) with a hole 20 mm in diameter and installation holes with the diameter of 4.2 mm

the sheets with rivets was modelled in ANSYS using “Bolt pretension” tool which enables one to set the force with which the factory and shop heads act on the surfaces to be joined.

In analyzing the results of calculations for titanium rivets (Fig. 16 and 17), it was found that the use of a strap locked in place with titanium rivets, each of which presses the patch down with 5kN, removes

maximum stresses away from the edge of the $d = 20$ mm hole, which should make it harder to initiate a crack. Above all, the application of such fasteners reduces the stresses on rivet holes, which should improve fatigue life of the joint considered here.

As mentioned when modelling a specimen with duralumin rivets, rivet clamp-up pressure of 500 N was assumed, and pressure inside of the rivet holes with 150 MPa was modelled, representing pressures from the expanding rivet shank. For such case, removal of maximum stresses away from the edge of the central hole was achieved, whereas significant concentration of stresses in the area of installation holes was found which can result in nucleation of fatigue cracks (Fig. 18). Based on this, it can be concluded that the relatively small force with which duralumin rivets clamp down the sheets is insufficient to remove the area of stress concentration away from the rivet holes (as is the case for titanium rivets), which may result in lower fatigue life of that joint.

6. Experimental tests of fatigue life of rivet and hybrid joints

5.1. Rivet joints

Fatigue tests of strapped joints (Fig. 6) were conducted with sinusoidal loads of $F_{\min} = 20,000$ N, $F_{\max} = 30,000$ N and frequency of 8 Hz. At maximum load, nominal stresses in a section which is weakened by the 20 mm hole were 250 MPa, which is below the yield strength of AW 2024T3 duralumin (which is about 330 MPa).

Fatigue life of the piece made of WA 2024T3 alloy 2 mm thick and size of 210x80 mm with a hole of 20 mm was 407,800 cycles, whereas of a part with additional rivet holes of $d = 4.2$ mm was 211,200. Fatigue cracks propagated through the central hole of $d = 20$ mm and through one of the rivet holes $d = 4.2$ mm. Obviously, the development of the crack results from the concentration of loads around the holes and coincides with the critical section of the specimen. The absence of crack symmetry can be explained by early initiation of the crack in the rivet hole and its subsequent expansion due to non-symmetric load. The appearance of the damage to the parts being tested is shown in Fig. 19.

Fatigue life of the specimen with rivet holes proved to be smaller than for the specimen with hole of $d = 20$ mm alone, which – as demonstrated by numerical calculations – results from a larger concentration of stresses at a hole with $d = 4.2$ mm.

Then, fatigue life of strapped joints was tested (repair of a damaged part made of AW 2024T3 alloy). The specimen of a joint made with ordinary rivets 3558A-4-10 was fatigue-damaged following 301,600 cycles (Fig. 20 a), and the damage differed from the damage made with static strain test (Fig. 20 b), and was similar to the damage of the part with central hole and installation holes (Fig. 19 b). The damage occurring in the static strain test runs through the critical section of the specimen, i.e., the central hole and two rivet holes. For the fatigue-stressed specimen ($F_{\max} = 30,000$ N), the mechanism of damage changes from local disruption of the specimen at the stress concentration site into the initiation of crack in one of the holes, development of the crack and complete breakup with non-symmetric load.

Also the other specimen repaired with ordinary rivets 3558A-4-10 was tested, and fatigue life of that specimen was 567,200 cycles, and the cracks propagated from two rivet holes. In this case, the cracks initiated symmetrically in two rivet holes.

Also strapped joints were tested, in which titanium rivets MB-F2110AB-05-150 were used for installation. The specimen with titanium rivets was fatigue-damaged following 957,200 cycles – Fig. 21 a. In this case, the crack did not run through the hole with $d = 4.2$ mm. Clamp-up pressures which are many times larger for titanium rivets result in a larger part of the load being transferred by sheet friction

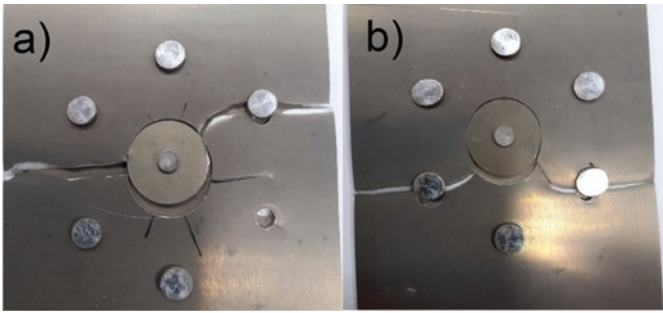

Fig. 20. Destruction of the strapped specimen fastened with ordinary rivets 3558A-4-10: (a) following fatigue test, (b) following static strain test

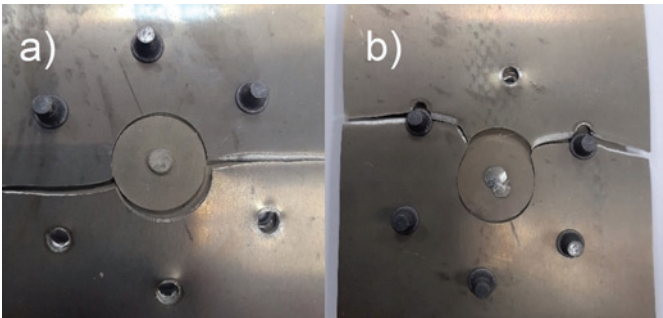

Fig. 21. Fracture of the strapped specimen riveted with fasteners: (a) following fatigue test, (b) following static strain test

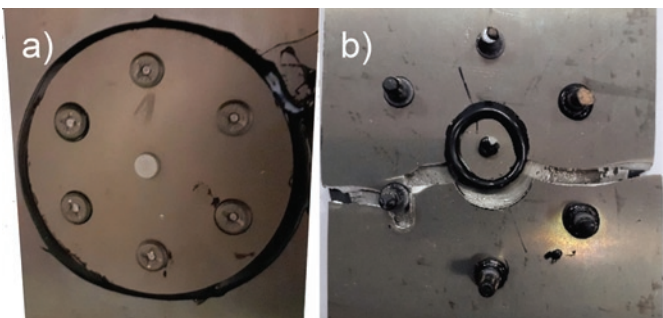

Fig. 22. View of a hybrid strapped joint (MBF2110AB-05-150 rivets and Raychem S1125 compound): (a) after preparation of specimen, (b) damaged in durability tests

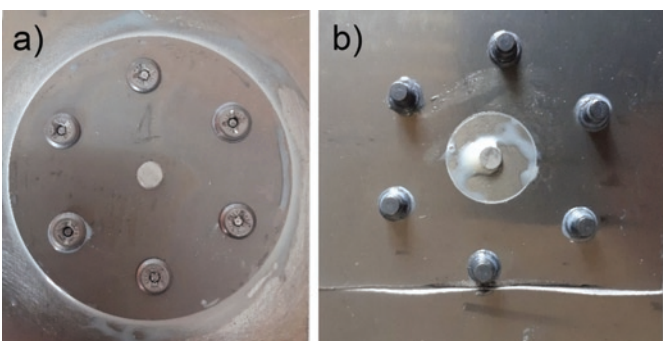

Fig. 23. View of a hybrid strapped joint (MBF2110AB-05-150 rivets and Epidian 57/Z1 compound): (a) after preparation of specimen, (b) damaged in durability tests

forces at the joint, and crack initiation sites are removed away from rivet hole critical sections. This makes the section along the center line of the 20 mm hole becoming the critical section, including due to maximum stresses occurring at this site, resulting from secondary bending (due to geometry of the strapped joint). Like for repairs made with ordinary rivets, the damage occurring in the static strain test (Fig.

21 b) runs through the critical section of the specimen, i.e., the central hole and two rivet holes.

5.2. Hybrid joints

In seeking ways to enhance fatigue life of strapped joints, fatigue life tests were conducted also for a hybrid joint which uses, in addition to titanium rivets MBF2110AB-05-150, adhesive material Raychem S1125 to install the strap. Such prepared specimen (Fig. 22 a) was also loaded with the following force range: $F_{\max} = 30,000$ N, $F_{\min} = 20,000$ N in a sinusoidal cycle with 8 Hz frequency. Following 3,059,100 load cycles and no specimen damage, the load was increased up to the range of $F_{\max} = 35,000$ N, $F_{\min} = 25,000$ N. Following further 328,200 cycles, the joint was damaged (Fig. 22 b), and the cracking was initiated on the hole with $d = 20$ mm (the fracture at the rivet occurred in the last phase of destruction). The improved fatigue life is due to additional adhesive forces bonding the surfaces, which exceed friction forces usually occurring in joints of such type between the parts joined together. The initiation of the crack on the central hole of the specimen was probably due to maximum stresses occurring at the site from secondary bending (due to the geometry of the strapped joint).

Hybrid joints were also tested by replacing the Raychem S1125 adhesive compound (with strong viscoelastic properties) with Epidian 57/Z1 structural adhesive which is much stronger than the Raychem compound (Fig. 23 a). The hybrid joint specimen was loaded with forces within the following range: $F_{\max} = 30,000$ N, $F_{\min} = 20,000$ N in a sinusoidal cycle with 8 Hz frequency. The joint was damaged following 1,506,300 load cycles. The crack initiated on the edge of the shop head along the specimen loading axis, and propagated first towards one edge of the specimen, and then in both directions (Fig. 23 b).

Inspection of the damaged specimen found that the pressures occurring during the installation of the rivets squeeze the adhesive compound out of the space between the joined parts. Any imperfection in the adhesive bond, especially around the installation holes, may affect fatigue life of the joint. Hence, more specimens of hybrid (bonded and riveted) joints were prepared, this time using ordinary rivets 3558A-4-10. Two variants of the strapped joint with Epidian 57 adhesive were prepared. They differed by the presence of a single layer of Synglass E81 glass fabric with basis weight 101 g/m^2 in the adhesive layer. Such prepared specimens were loaded with forces within the following range: $F_{\max} = 30,000$ N, $F_{\min} = 20,000$ N in a sinusoidal cycle with 8 Hz frequency. The hybrid joint without glass fabric was damaged following 751,100 load cycles, and with the glass fabric following 1,017,400 load cycles. In the joint with no fabric, the crack propagated from the hole with $d = 20$ mm (Fig. 24 a), and in the joint with fabric – it propagated from the outlying fastener (Fig. 24 b). In addition, durability was determined for a specimen joined with ordinary rivets 3558A-4-10 and bonded with Raychem S1125 adhesive. The joint was damaged following 950,597 load cycles.

Similar testing was conducted for a hybrid joint using titanium rivets and Raychem S1125 compound, but with modifying the bond by adding Synglass E81 glass fabric. In expectation for improved fatigue performance, such prepared specimen was loaded with increased forces within the range of: $F_{\max} = 35,000$ N, $F_{\min} = 25,000$ N in a sinusoidal cycle with 8 Hz frequency. The sample was damaged following 3,114,700 load cycles. As shown in Fig. 25, the crack propagated from hole $d = 20$ mm.

Fatigue life of the strapped joints tested is compared in Table 3.

Testing results summarized in Table 3 and numerical calculations show that the smaller rivet holes result in more concentration of stresses than the large central hole with the diameter of $d = 20$ mm. Hence, it turns out that, in terms of fatigue life, repair of pieces with a central hole and a strap fastened with ordinary rivets 3558A-4-10 (strapped joints) is less effective than no repair at all (a piece with central hole with the diameter of $d = 20$ mm had larger fatigue life than a piece repaired with ordinary rivets). Blind rivets MBF2110AB-05-150 were an effective

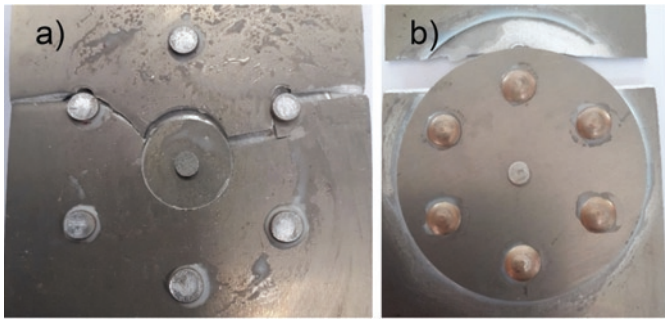

Fig. 24. Fatigue damage of a hybrid joint (3558A-4-10 rivets plus Epidian 57/Z1 compound): (a) with no glass fabric, (b) with glass fabric



Fig. 25. Fatigue damage of a hybrid strapped joint (MBF2110AB-05-150 rivets and Raychem S1125 compound with a layer of Synglass E81 fabric)

solution. Fatigue life of the repair joint with titanium rivets was twice as much as for a piece with a central hole.

Experimental tests have clearly demonstrated that titanium blind rivets perform better than ordinary rivets in terms of ensuring fatigue life of joints of pieces made of AW 2024T3 aluminum alloy.

Also, the use of hybrid (adhesive & riveted) joints has been found to be viable in strapped joints, e.g., in repairs of damaged skin of aircraft. Better fatigue life was achieved by using a less rigid adhesive compound (lower Young's modulus), i.e., Raychem S1125 adhesive. The rigid adhesive bond achieved with Epidian 57/Z1 resulted in poorer fatigue life.

A major problem with making hybrid joints before the adhesive compound is cured is the quality of the adhesive bonds so made. Pressures exerted by fasteners during installation squeeze out the adhesive compound out in the area of the joint, and the effective area of the adhesive joint is less than the geometrical size of a bonded strap (Fig. 26a). Not insignificant in terms of fatigue life of hybrid joints is the absence of the adhesive material around installation holes where stresses concentrate. The presence of adhesive in such sites would significantly reduce stress concentration factors. As demonstrated by the outcomes of experimental tests, a solution to this problem may be to add a filler layer to the adhesive material to reduce the adverse effect of the adhesive being squeezed out during the installation of fasteners. These researchers have successfully applied a layer of glass fabric whose presence in the joint does not adversely affect the adhesive strength of the bond (Fig. 26 b,c).

7. Conclusions

Based on experimental studies and numerical calculations we have found that fatigue life of joints in workpieces made of aluminum alloy AW 2024T3 can be improved by using titanium driven blind bolts with pin MBF2110AB-05-150 instead of ordinary, hammer-bucked rivets 3558A-4-10. Another beneficial solution to improve the durability of riveted joints is to replace them with hybrid (rivet & adhesive) joints.

The use of MBF2110AB-05-150 rivets instead of 3558A-4-10 in helicopter repairs should significantly reduce the problem of secondary fatigue damage to the repaired airframe structures.

Table 3. Comparison of fatigue life of workpieces with holes and strapped joints

No.	Specimen type	Cycles to damage
1	Piece with hole $d = 20$ mm	407,800
2	Piece with hole $d = 20$ mm and six installation holes $d_1=4.2$ mm	211,200
3	Strapped joint – 3558A-4-10 rivets	301,600
4	Hybrid strapped joint – 3558A-4-10 rivets and Epidian 57/Z1 adhesive compound	751,100
5	Modified hybrid strapped joint – 3558A-4-10 rivets, Epidian 57/Z1 with glass fabric	1,017,400
6	Strapped joint – 3558A-4-10 rivets, Raychem S1125 adhesive compound	950,597
7	Strapped joint – MBF2110AB-05-150 titanium rivets	957,200
8	Hybrid strapped joint – MBF2110AB-05-150 titanium rivets and Epidian 57/Z1 adhesive compound	1,506,300
9	Modified hybrid strapped joint – MBF2110AB-05-150 rivets, Epidian 57/Z1 with glass fabric	> 3,015,300 (3,015,300 cycles with load of 30 – 20 kN and additional 1,947,000 cycles with load of 35 - 25 kN)
10	Hybrid strapped joint – MBF2110AB-05-150 rivets, Raychem S1125 compound	> 3,059,100 (3,059,100 cycles with load of 30 – 20 kN and additional 328,200 cycles with load of 35 - 25 kN)
11	Modified hybrid strapped joint – MBF2110AB-05-150 rivets, Raychem S1125 with glass fabric	3,114,700 (with load increased to 35 – 25 kN)

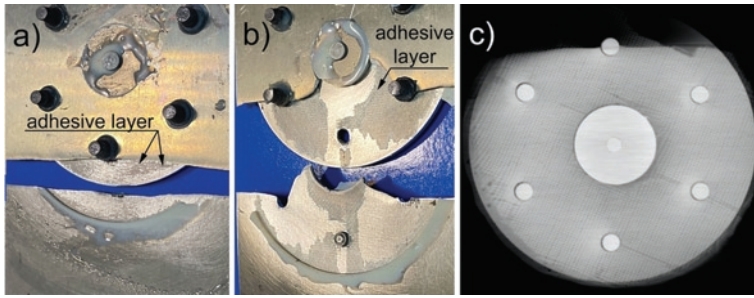

Fig. 26. View of adhesive bond: (a) in hybrid strapped joint without glass fabric, (b) in hybrid strapped joint with a layer of glass fabric, (c) following the analysis with computer-assisted tomograph in the hybrid strapped joint with a layer of glass fabric

Our studies have confirmed that the fasteners compared during the testing transfer loads differently: by friction of strongly pressed down factory and shop heads of MBF2110AB-05-150 and shearing of bucked rivets 3558A-4-10. Numerical calculations have found that both the pressing down jointed elements by heads with appropriate force and pressure of shanks of deformed rivets on hole walls remove

the largest stresses away from hole edges. This effect is much stronger for titanium rivets than for duralumin rivets, which results in longer delay of crack initiation in joints with titanium rivets, thus improving fatigue life of such joints relative to joints using ordinary duralumin rivets.

Experimental tests have also demonstrated the viability of replacing riveted joints with hybrid (riveted & adhesive) joints in repairs of airframe structures. In addition to other useful properties of such joints, e.g., their airtightness, fatigue life of the repaired site can be significantly improved. The magnitude of increased fatigue life depends on the type of the adhesive material used in the joint. Adhesive compounds with moderate rigidity provide for better effects, because then fasteners are loaded more evenly and are better strained. Hence damage of the adhesive bond (which is damaged first) of a hybrid joint will occur later and its fatigue life will be better compared to “pure” riveted joints. At the same time, one should remember that as a result of pressures occurring during the installation of fasteners, the adhesive joint is degraded. This adverse outcome can be significantly reduced by physically modifying the adhesive bond with fillers, e.g., thin fabrics made of glass fibers.

References

1. Abdel Wahab M M. Fatigue in adhesively bonded joints: a review. *ISRN Materials Science* 2012; 2012: 1-25, <https://doi.org/10.5402/2012/746308>.
2. Alderliesten R C. Introduction to aerospace structure and materials, Delft University of Technology, 2018.
3. Banea M D, da Silva L F M, Campilho R D S G, Sat, C. Smart adhesive joints: an overview of recent developments. *The Journal of Adhesion* 2014; 90: 16-40, <https://doi.org/10.1080/00218464.2013.785916>.
4. Budhe S, Banea M, D, de Barros S, da Silva L. An updated review of adhesively bonded joints in composite materials, *International Journal of Adhesion & Adhesives* 2017; 72: 30-42, <https://doi.org/10.1016/j.ijadhadh.2016.10.010>.
5. Chang P, Wang J, Wing Kong Chiu, Nabil M. Chowdhury. Experimental and finite elements studies of bolted, bonded and hybrid step lap joints of thick carbon fibre/epoxy panels used in aircraft structures, *Composites Part B* 2016; 100: 68-77, <https://doi.org/10.1016/j.compositesb.2016.06.061>.
6. Chaves F J P, da Silva L F M, de Moura M F S F, Dillard D A, Esteves V H C. Fracture mechanics tests in adhesively bonded joints: a literature review. *The Journal of Adhesion* 2014; 90: 955-92, <https://doi.org/10.1080/00218464.2013.859075>.
7. Costa M, Viana G, da Silva L F M, Campilho R D S G. Environmental effect on the fatigue degradation of adhesive joints: a review. *The Journal of Adhesion* 2016; 93: 1-2, 127-146, <https://doi.org/10.1080/00218464.2016.1179117>.
8. da Silva L F M, das Neves P J C, Adams R D, Wang A, Spelt J K. Analytical models of adhesively bonded joints-Part II: comparative study *International Journal of Adhesion and Adhesives* 2009; 29: 331-41, <https://doi.org/10.1016/j.ijadhadh.2008.06.007>.
9. da Silva, L F M, das Neves P J C, Adams R D, Spelt J K. Analytical models of adhesively bonded joints-Part I: literature survey. *International Journal of Adhesion and Adhesives* 2009; 29: 319-30, <https://doi.org/10.1016/j.ijadhadh.2008.06.005>.
10. Gąsior J, Komorek A, Rośkowicz M, Tkaczuk S. Ocena możliwości zastąpienia nitów typu solid w połączeniach konstrukcji lotniczych (Assessment of the potential to replace solid rivets in aircraft structural joints). *Technologia i Automatykacja Montażu* 2018; 2/2018: 53-56.
11. Godzimirski J, Rośkowicz M. Selection of joints for testing fatigue life of aviation rivets. *Technologia i Automatykacja Montażu* 2020; 2/2020: 17-20.
12. Gruber M L, Wilkins K E, Worden R E. Investigation of fuselage structure subject to widespread fatigue damage. In: Bigelow, C.A. (ed.) *Proceedings of FAA/NASA Symposium on the Continued Airworthiness of Aircraft Structures*, Atlanta, GA, 28-30 Aug 1996; DOT/FAA/AR-97/2: 439-459.
13. Harish G, Farris T N, Wang H L, Grandt A F. Nucleation and growth of cracks in lap joints. In: 1999 USAF Aircraft Structural Integrity Program Conference, 30 Nov-2 Dec 1999; San Antonio; TX: 1-14.
14. Hartman A. Fatigue tests on single lap joints in clad 2024-T3 aluminum alloy manufactured by a combination of riveting and adhesive bonding. Report NLR M.2170. NLR, Amsterdam, 1966.
15. Hartman A. Some tests on the effect of fatigue loading on the friction in riveted light alloy specimens. Report NLR M. 2008. NLR, Amsterdam, 1961.
16. He, X., A review of finite element analysis of adhesively bonded joints. *International Journal of Adhesion and Adhesives* 2011; 31: 248-64, <https://doi.org/10.1016/j.ijadhadh.2011.01.006>.
17. Heshmati M, Haghani R, Al-Emrani M. Environmental durability of adhesively bonded FRP/steel joints in civil engineering applications: state of the art. *Composites Part B: Engineering* 2015; 81: 259-75, <https://doi.org/10.1016/j.compositesb.2015.07.014>.
18. Jones R, Baker A, Matthews N, Champagne V. *Aircraft Sustainment and Repair*. Butterworth-Heinemann, 2018; <https://doi.org/10.1016/C2014-0-03919-6>.
19. Katnam K B, Comer A J, Roy D, da Silva L F M, Young T M. Composite repair in wind turbine blades: an overview. *The Journal of Adhesion* 2015; 91: 113-39, <https://doi.org/10.1080/00218464.2014.900449>.
20. Katnam K B, da Silva L F M, Young T M. Bonded repair of composite aircraft structures: a review of scientific challenges and opportunities. *Progress in Aerospace Sciences* 2013; 61: 26-42, <https://doi.org/10.1016/j.paerosci.2013.03.003>.
21. Klimaszewski S, Leski A, Dragan K, Kurdelski M, Wrona M. Helicopter Structural Integrity Program Of Polish Mi-24 Hind Helicopters.

- In: Bos M.J. (eds) Proceedings of the 25th Symposium of the International Committee on Aeronautical Fatigue, Bridging the Gap between Theory and Operational Practice. Springer, Dordrecht 2009, https://doi.org/10.1007/978-90-481-2746-7_16.
22. Komorek A, Przybyłek P. Examination of the influence of cross-impact load on bend strength properties of composite materials, used in aviation. *Eksploracja i Niezawodność - Maintenance and Reliability* 2012; 14(4): 265-269.
 23. Marques E A S, da Silva L F M, Banea M D, Carbas R J C. Adhesive joints for low- and high-temperature use: an overview. *The Journal of Adhesion* 2015; 91: 556-85, <https://doi.org/10.1080/00218464.2014.943395>.
 24. Müller R P G. An experimental and analytical investigation on the fatigue behavior of fuselage riveted lap joints. The significance of the rivet squeeze force, and a comparison of 2024-T3 and Glare 3. Ph.D. thesis, TU Delft, Delft, 1995.
 25. Pitta S, de la Mora Carles V, Roure Fernández F, Crespo Artiaga D, Rojas Gregorio J I. On the static strength of aluminium and carbon fibre aircraft lap joint repairs, *Composite Structures* Volume 201, 1 October 2018: 276-290, <https://doi.org/10.1016/j.compstruct.2018.06.002>.
 26. Rośkowicz M, Smal T. Research on durability of composite materials used in repairing aircraft components. *Eksploracja i Niezawodność - Maintenance and Reliability* 2013; 15 (4): 349-355.
 27. Rudawska A, Dębski H. Experimental and numerical analysis of adhesively bonded aluminium alloy sheets joints. *Eksploracja i Niezawodność - Maintenance and Reliability* 2011; 1(49): 4-10.
 28. Sauer R A. A survey of computational models for adhesion. *The Journal of Adhesion* 2016;92:81-120, <https://doi.org/10.1080/00218464.2014.1003210>.
 29. Schijve J. Fatigue life until small cracks in aircraft structures. Durability and damage tolerance. In: Harris, Ch.E. (ed.) Proceedings of the FAA/NASA International Symposium on Advanced Structural Integrity Methods for Airframe Durability and Damage Tolerance, Hampton, VA, 4-6 May 1994, NASA CP 3274: 665-680.
 30. Schijve, J. Multiple-site-damage of riveted joints. In: Atluri S.N., Harris C.E., Hoggart A., Miller N., Sampath, S.N.: International Workshop on Structural Integrity of Ageing Airplanes, Durability of Metal Aircraft Structures, Atlanta, GA, 31 Mar-2 Apr 1992. Atlanta Technical Publication, Atlanta; 1992: 2-27.
 31. Schra L, Ottens H H, Vlieger H. Fatigue crack growth in simulated Fokker 100 lap joints under MSD and SSD conditions. Report NLR CR 95729 C. NLR, Amsterdam; 1995.
 32. Schütz W. Zeitfestigkeit einschichtiger Leichtmetall-Nietverbindungen. Bericht Nr. F-47. Laboratorium für Betriebsfestigkeit, Darmstadt, 1963.
 33. Segerfröjd G, Wang G S, Palmberg B, Blom A F. Fatigue Behavior of Mechanical Joints: Critical Experiments and Statistical Analyses, ICAF 97: Fatigue in New and Ageing Aircraft: Proceedings of the 19th Symposium of the International Committee on Aeronautical Fatigue, Engineering Materials Advisory Services, Clifton-upon-Teme, England, U.K., 18-20 June 1997: 575-598.
 34. Segerfröjd G, Zuccherini S, Giovannelli G, Magnusson L. Fatigue behavior of Mechanical Joints - An experimental evaluation of ten different fastener systems and their influence on fatigue life. Combined Report, The Aeronautical Research Institute of Sweden, Report No. FKH R-4105, Sweden, January, 1997.
 35. Skorupa A, Skorupa M. Riveted Lap Joints in Aircraft Fuselage - Design, Analysis and Properties. Springer Dordrecht Heidelberg New York London, 2012, <https://doi.org/10.1007/978-94-007-4282-6>.
 36. Skorupa M, Skorupa A, Machniewicz T, Korbel A. An experimental investigation on the fatigue performance of riveted lap joint. In: Bos, M.J. (ed.) Proceedings of the 25th Symposium of the International Committee on Aeronautical Fatigue, Bridging the Gap between Theory and Practice, Springer, Rotterdam, 27-29 May 2009: 449-473, https://doi.org/10.1007/978-90-481-2746-7_26.
 37. Steadman D, Carter A, Ramakrishnan R. Characterisation on MSD in an in-service fuselage lap joint. In: 3rd Joint FAA/DoD/NASA Conference on Aging Aircraft, Albuquerque, N.M., Sept 1999 (Proceedings on CD-Rom); 1999.
 38. Stępień S, Szajnar S, Jaształ M. Problems of military aircraft crew's safety in condition of enemy counteraction. *Eksploracja i Niezawodność - Maintenance and Reliability* 2017; 19 (3): 441-446, <https://doi.org/10.17531/ein.2017.3.15>.
 39. Szolwinski M P. The mechanics and tribology of fretting fatigue with application to riveted lap joints, PhD dissertation West Lafayette, IN, USA Purdue University, USA, 1998.
 40. Szymczyk E. Numeryczna analiza zjawisk lokalnych w połączeniach nitowych konstrukcji lotniczych (Numerical analysis of local phenomena in riveted joints of aircraft structures). WAT, Warszawa, 2016.
 41. Turaga V R S, Umamaheswar, Ripudaman Singh, Modelling of a patch repair to a thin cracked sheet, *Engineering Fracture Mechanics*, Volume 62, Issues 2-3, January-February 1999: 267-289, [https://doi.org/10.1016/S0013-7944\(98\)00088-5](https://doi.org/10.1016/S0013-7944(98)00088-5).
 42. Underhill P R, Juurlink J, DuQuesnay D L. The use of safety cuts in fatigue damaged fastener hole repair, *International Journal of Fatigue* 91, Part 1, October 2016: 242-247, <https://doi.org/10.1016/j.ijfatigue.2016.06.014>.
 43. Urban M R. Analysis of the fatigue life of riveted sheet metal helicopter airframe joints, *International Journal of Fatigue*; 2003; 25: 1013-1026, <https://doi.org/10.1016/j.ijfatigue.2003.08.003>.
 44. Witkowski R. Wprowadzenie do wiedzy o śmigłowcach (Introduction to helicopter topics). Biblioteka Naukowa Instytutu Lotnictwa, Warsaw, Poland, 1998.