

Study of all-optical logic XOR gate based on linear optical amplifier cross-gain modulation

XI LI^{1, 2*}, JIE JIN¹, HAITAO LI³, QIANG ZHANG¹

¹School of Electronic Information Engineering, Tianjin University, Tianjin, 300072, China

²Department of Information Engineering, Tangshan College, Tangshan, 600031, China

³CASIC-CQC Software Testing and Assessment Technology Corporation, Beijing, 100048, China

*Corresponding author: xil016@tju.edu.cn

All-optical logic is the key to future high speed and large capacity optical transmission, the realization of optical packet switching and optical computing, and it has a very profound influence on the development of future optical communication. A linear optical amplifier as a new type of semiconductor optical amplifier, which has a good gain characteristic, has better signal performance than a traditional semiconductor optical amplifier in the wavelength conversion. This article presents a numerical simulation model of all-optical logic XOR gate and its logic operation based on cross-gain modulation of linear optical amplifier, and has also completed some of the basic logic operations, including AND, OR, NOT operations.

Keywords: linear optical amplifier, cross-gain modulation, XOR gate.

1. Introduction

All-optical signal processing technology is widely used for exchange, judgment, regeneration, and some basic or complex optical operations in the region of current communication and computing. The key to achieve all-optical signal processing is logic gate devices. In recent years, the development of high speed all-optical logic devices mainly use a semiconductor optical amplifier (SOA), which has small volume, easy integration, working wavelength range wide, as well as good dynamic characteristic. However, a new type of a SOA, named linear optical amplifier (LOA), in the field of optical amplifier in charm, has attracted much attention [1]. This optical amplifier adopts Cross CavityTM technology: using the built-in laser structure, the SOA induces an in-

tegrated vertical-cavity surface -emitting laser (VCSEL). The VCSEL and the amplifier share the same active region, which can clamp the gain, increase the gain of linear range, and reduce the crosstalk between channels. The application of LOA in the field of nonlinear is the current focus of research both at home and abroad, and its solution has obtained the better signal performance than traditional SOA in the wavelength conversion, optical signal regeneration, and the clock signal recovery experiment [2–5].

Scheme of cross-gain modulation (XGM) has a simple structure, and the realization of the logic functions just rely on optical power, without precise controlling of the phase of optical signal [6]. Combined with the principle and advantages of LOA-XGM, this paper successfully builds a simulation model of an all-optical logic XOR gate. We have divided four LOA into two groups to cascade in the Simulink model and used the principle of XGM to obtain the better output results.

2. Principles

All-optical logic XOR gate based on LOA-XGM principle diagram was shown in Fig. 1. Four LOA in series were divided into two groups, where LOA1 and LOA2 was the first level input and output, LOA3 and LOA4 for second level input and output. The continuous wave (CW), as the probe (wavelength λ_1), and the signal A , as the strong pump (wavelength λ_2), inject LOA1 together, the continuous wave (CW), as the probe (wavelength λ_1), and the signal B , as the strong pump (wavelength λ_3), also inject LOA2 together. When the signal A and B are the bit “1”, which consumes carrier density of LOA1 and LOA2, the CW can be saturated absorption through the LOA1 and LOA2, then the output is “0”. Only when the signal A and B are the bit “0”, the CW can be amplified through LOA1 and LOA2, then the output is “1”, so can achieve the NOT operation, the first level LOA1 output is \bar{A} , the first level LOA2 output is \bar{B} . Using the same principle, let output signal \bar{A} of first level LOA1 as the strong pump and output signal \bar{B} of the first level LOA2 as the probe, and input them together into second level LOA3, then the output of the second level LOA3 is $\overline{\bar{A} \cdot \bar{B}} = A \cdot B$, which realizes logic AND operation of the signal A and B .

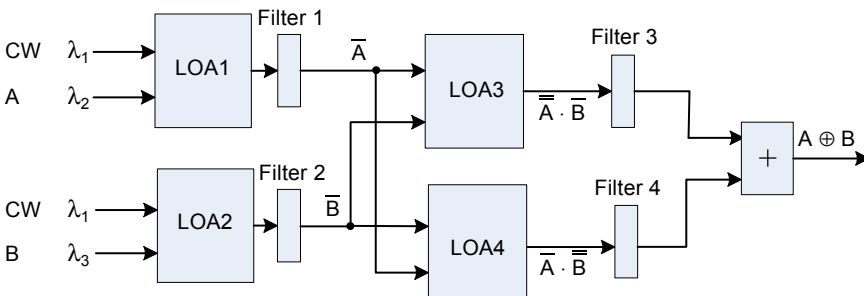

Fig. 1. Schematic diagram for logic XOR gate based on LOA-XGM.

Table 1. The truth table of XOR.

A	B	\bar{A}	\bar{B}	$\bar{\bar{A}} \cdot \bar{\bar{B}} = A \cdot B$	$\bar{A} \cdot \bar{\bar{B}} = \bar{A} \cdot B$	$A \oplus B$
1	1	0	0	0	0	0
0	1	1	0	0	1	1
1	0	0	1	1	0	1
0	0	1	1	0	0	0

Also let output signal \bar{A} of first level LOA1 as the probe, output signal \bar{B} of the first level LOA2 as the strong pump, and input them together into second level LOA4, then the output of the second level LOA4 is $\bar{A} \cdot \bar{\bar{B}} = \bar{A} \cdot B$, which realizes logic AND operation of the signal \bar{A} and B . Finally, let both output of LOA3 and LOA4 to be the OR operation, thus it can achieve $A \cdot \bar{\bar{B}} + \bar{A} \cdot B = A \oplus B$ and realize logic XOR operation of the signal A and B . The truth table of all-optical XOR logic gate was listed in Table 1.

3. Mathematical model

LOA is generally working in a deep saturation state, when it was used for all-optical logic gates, so in order to simplify the calculation, the following numerical calculation ignores the effects of amplifier spontaneous emission (ASE) noise. Carrier density N of LOA in the active area, the vertical-cavity laser (VCL) rate equations of photon density S and optical power transmission equation can be expressed as follows [7, 8]:

$$\frac{\partial N}{\partial t} = \frac{I}{eV} - F(N) - \sum_{i=1,2} \frac{\Gamma g_i(N, \lambda_i)}{shc/\lambda_i} p_i(z, t) - v_g g_L(\lambda_L, N) S \quad (1)$$

$$\frac{dS}{dt} = \Gamma_L v_g g_L(N, \lambda_L) S - \frac{S}{\tau_{ph}} + F_{L,sp}(N) \quad (2)$$

$$\frac{\pm \partial P_i(z, t)}{\partial z} = P_i(z, t) \left[\Gamma g_i(N, \lambda_i) - \alpha_{int} \right] \quad (3)$$

where I is the injection current, e is the electron charge, V is the volume of the active region, s is the effective cross-sectional area of SOA active area, h is Planck constant, c is the speed of light, $F(N) = AN + BN^2 + CN^3$ is the recombination rates (A , B , C are the coefficients of nonradiative recombination, radiative recombination and Auger recombination, respectively), P_i is the wavelength of λ_i corresponding to the optical power, symbol + and - is respectively corresponding to light wave propagation along the direction of +z and -z, and α_{int} is the internal loss factor of LOA; Γ is the optical

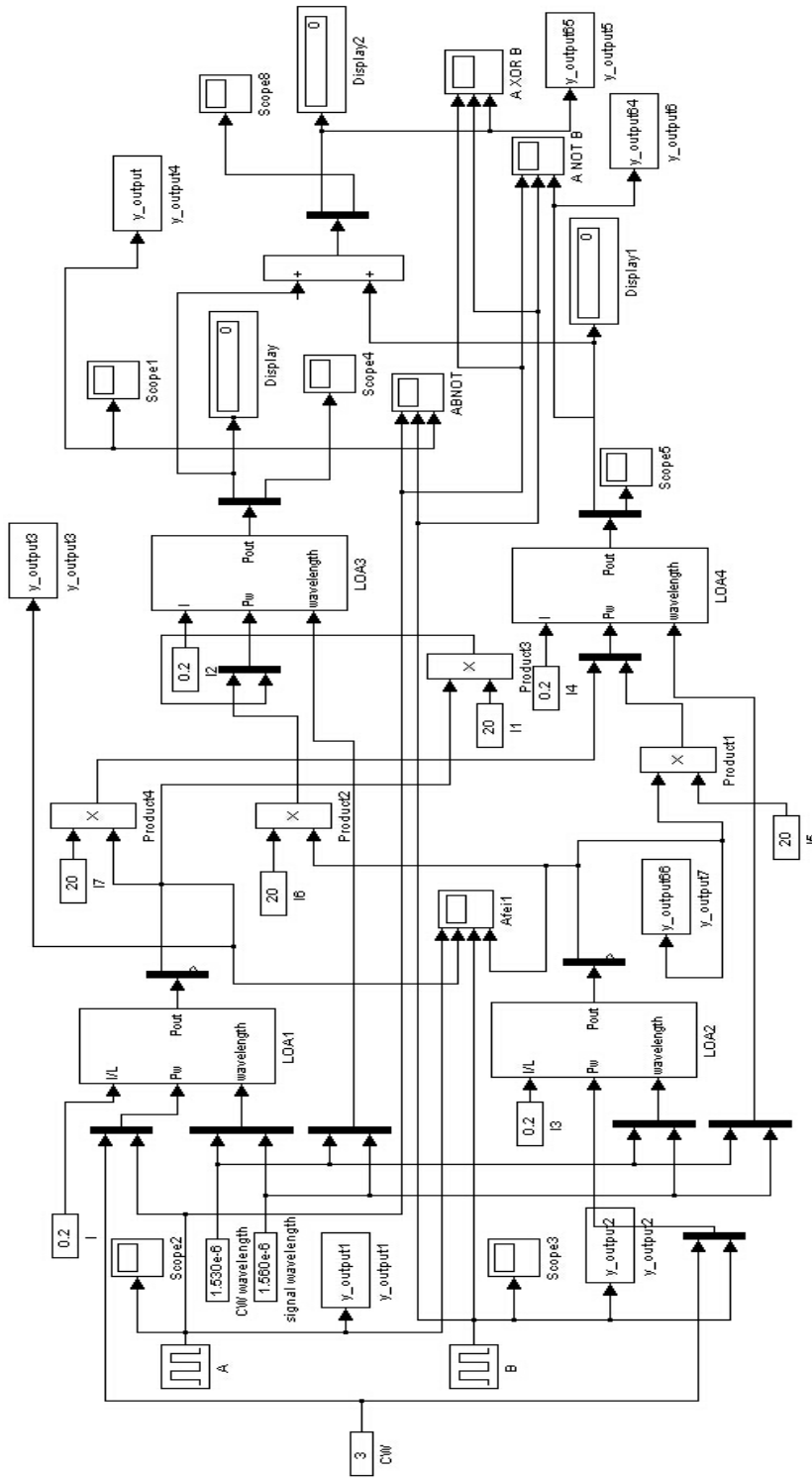

Fig. 2. The Simulink module structure of logic XOR gate based on LOA-XGM.

confinement factor, Γ_L is the confinement factor of the VCL, v_g is the group velocity, τ_{ph} is the photon lifetime, g_i and g_L are the gain corresponding to the wavelength λ_i and the VCL wavelength λ_L , respectively, and the relationship between them and the carrier density and wavelength was described as follows [9]:

$$g_i(N, \lambda_i) = g_N(N - N_0) - \gamma_1(\lambda_i - \lambda_p)^2 + \gamma_2(\lambda_i - \lambda_p)^3 \quad (4)$$

$$\lambda_p(N) = \lambda_t - k_0(N - N_0) \quad (5)$$

where g_N is the differential gain coefficient, N_0 is the transparent carrier density, λ_p is the gain wavelength of peak, γ_1 and γ_2 are the coefficient relate to the bandwidth of the gain spectrum and asymmetry, respectively, λ_t is the gain wavelength of peak as $N = N_0$, k_0 is the coefficient of wavelength drift, and the carrier recombination rate related to spontaneous emission is given by $F_{L, sp}(N) = \beta_A AN + \beta_B AN^2 + \beta_C AN^3$, β_i ($i = A, B, C$) is the spontaneous emission factor, which represents spontaneous radiation's contribution to the lasing mode share.

For the above equations, the segmentation model of LOA is used to solve them, and we regard the whole LOA as being consisted of M equal length sections in series. When M is large enough, the carrier density of these subsections can be approximately considered as uniform, without changing with spatial coordinates, so we study the change rule of the carrier density time in active area of LOA. On the premise of guarantee accuracy, LOA is divided into 10 sections to shorten the operation time. We established the Simulink module structure of the above equations as shown in Fig. 2, and it can be achieved all-optical logic XOR operation by the numerical simulation.

4. Results and discussion

We suppose the length of LOA is 1000 μm , ignoring the cavity reflectivity. Working current is made the appropriate adjustments in the range of 50–150 mA. Both signal A and B are non-return-to-zero (NRZ) signal, their code patterns are “1010101010” (period T_A is 100 ps) and “110011001100” (period T_B is 200 ps), both of their wavelength are 1560 nm, wavelength of CW is 1530 nm. In this paper, the parameters used for simulation are shown in Table 2.

4.1. Output results of all levels of all-optical logic operation

Figure 3 shows the output results of the first level LOA1 and LOA2, where injection currents of both of them are 80 mA, and the power of both A and B is 10 mW. As expected, on the basis of principle of XGM, we conducted a numerical simulation by the segmentation model of the LOA, and got the first-level LOA1 output waveform \bar{A} and LOA2 output waveform \bar{B} . From Fig. 3, we can also observe that output power of \bar{A} and \bar{B} reduces to about 0.46 mW. According to the optical power transmission (Eq. (3)), it is known that power reduction is mainly affected by the internal losses, carrier density, gain coefficient and so on. Due to lower output power against the op-

Table 2. Typical parameters of LOA [7, 8].

Symbol	Description	Value
L [μm]	Active region length	1000
d [μm]	Active region thickness	0.2
w [μm]	Active region width	1
N_0 [μm^{-3}]	Carrier density transparency	0.9×10^6
α_{int} [μm^{-1}]	Material loss	2.5×10^{-3}
g_N [μm^2]	Differential gain constant	2.5×10^{-8}
Γ	Confinement factor	0.3
v_g [$\mu\text{m}/\text{ns}$]	Group velocity	7.5×10^4
γ_1 [μm^{-3}]	Gain spectrum coefficient 1	7.4
γ_2 [μm^{-4}]	Gain spectrum coefficient 2	31.55
k_0 [μm^4]	Material gain constant	3×10^{-8}
A [ns]	Nonradiative recombination coefficient	0.25
B [$\mu\text{m}^3/\text{ns}$]	Bimolecular recombination coefficient	1.0×10^{-8}
C [$\mu\text{m}^6/\text{ns}$]	Auger recombination coefficient	9.4×10^{-14}

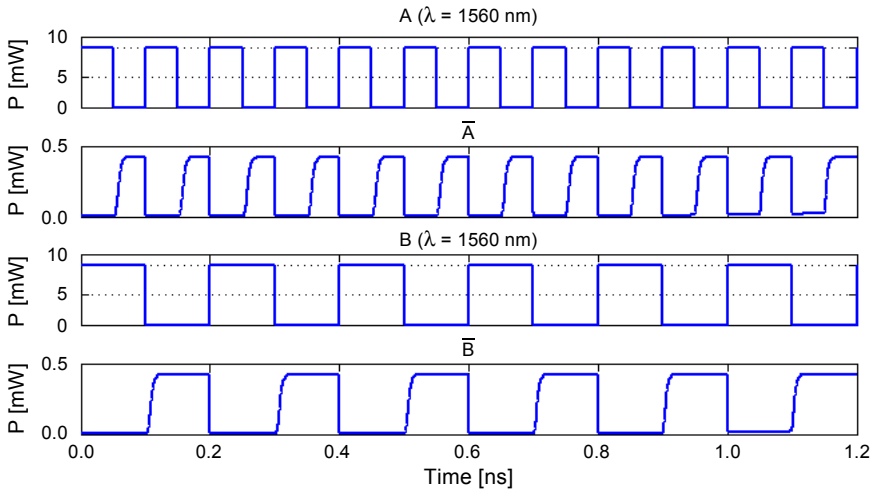

Fig. 3. Output results of first level of LOA1 and LOA2.

erations of second level LOA, we magnify 20 times output power of first level LOA, and then put it into the second level LOA. Figures 4 and 5 illustrate the logical output results of second level LOA3 and LOA4, respectively. We successfully complete the logic AND operation of the \bar{A} and B , as well as \bar{B} and A . Finally, the output of LOA3 plus the output of LOA4 is $A \oplus B$, realized logic XOR operation of the signal A and B , as can be seen in Fig. 6. We can observe that output waveforms have caused distortion, because in XGM, input pump can modulate gain of LOA, to implement modulation of the probe. Since the different section input signal gets a different gain, carrier density

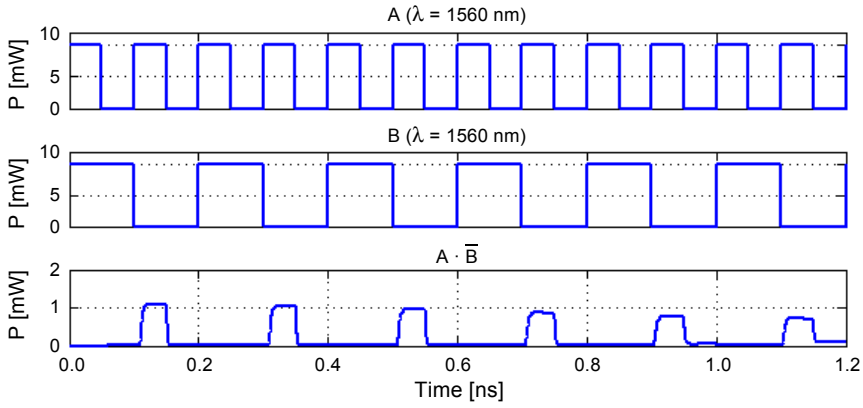

Fig. 4. Logical AND output results of second level of LOA3.

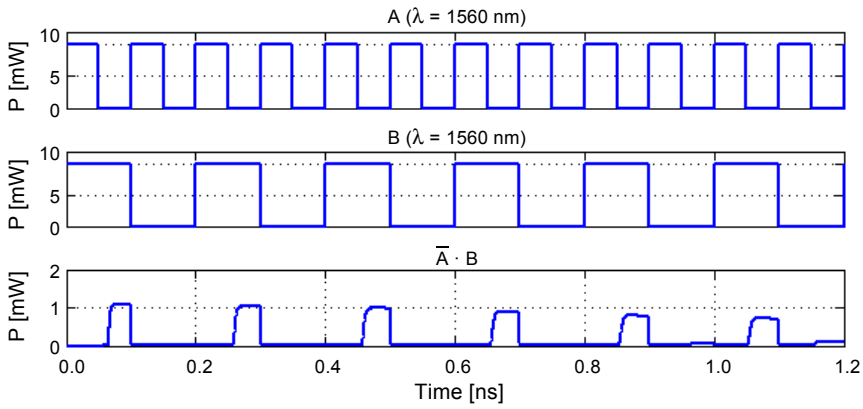

Fig. 5. Logical AND output results of second level of LOA4.

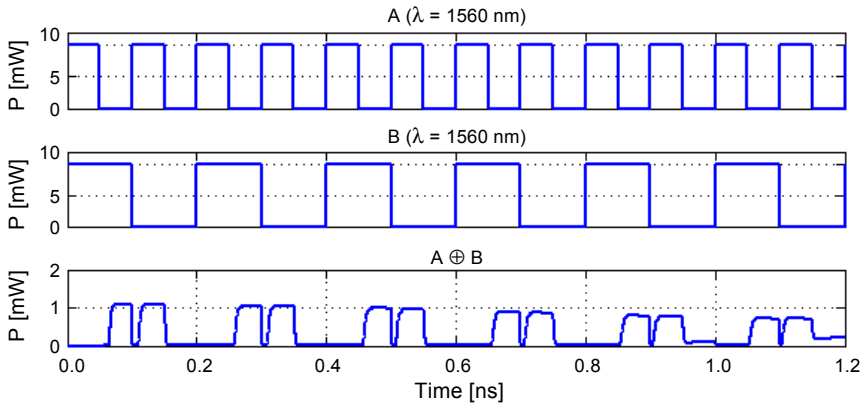

Fig. 6. All optical logical XOR output results.

also varies with the input pumping waveform changes, so it leads to the distortion of the output signal waveform.

4.2. The impact of input signal wavelength on logic XOR operation result

The wavelength of probe and pump can influence the logical operation output results, as shown in Fig. 7, probe wavelength changes in the range of 1520–1560 nm. We can observe that when the wavelength is 1520 nm, output waveform distortion is larger with the increase of wavelength, and output waveform distortion gradually becomes smaller. But when wavelength gradually increased upon 1550 nm, there are extra small peaks of output waveform, and with the increase of wavelength, small peaks also increased. Because with the increase in probe wavelength, the carrier density and gain discrepancy between the “0” and “1” signal become smaller, as well as the extinction ratio is smaller [10], so the output signals have a distortion.

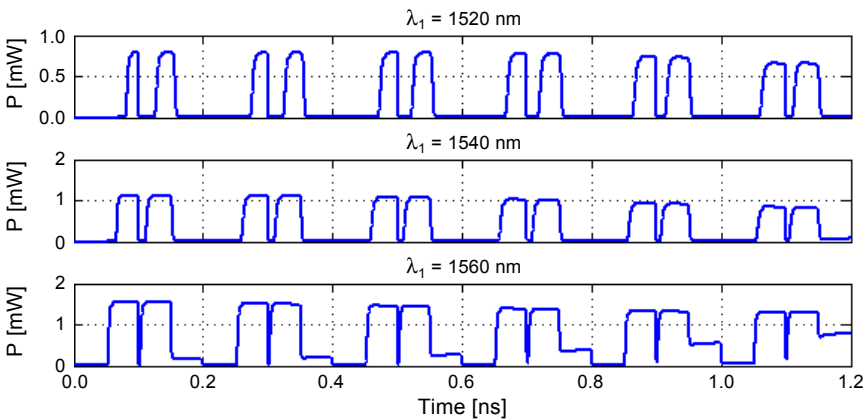

Fig. 7. All optical XOR logic output result for different probe wavelength.

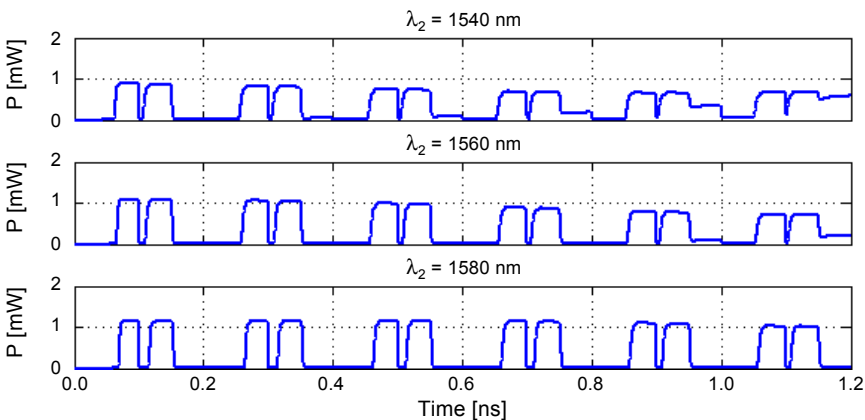

Fig. 8. All optical XOR logic output result for different pump wavelength.

In Figure 8, pump wavelength changes in the range of 1540–1580 nm, contrary to Fig. 7. With the increased pump wavelength, the output distortion is smaller. This is because when over 1560 nm wavelength range, LOA gain curve slope is very large [10], due to the gain saturation effect. The physical process of XGM shows that when the modulation amplitude is increased, the extinction ratio is increased. Therefore, one should properly choose the probe wavelength between 1520–1540 nm and choose larger pump wavelength, which is beneficial to improve final output results.

4.3. The impact of optical power on logic XOR operation result

Figures 9 and 10 show the impact of optical power on logic operation result. From the figures we can observe that with the increase in the input signal optical power, the output waveforms are much better. This is because the deeper the degree of modulation of LOA, the input optical power of the first level is greater, and the XGM

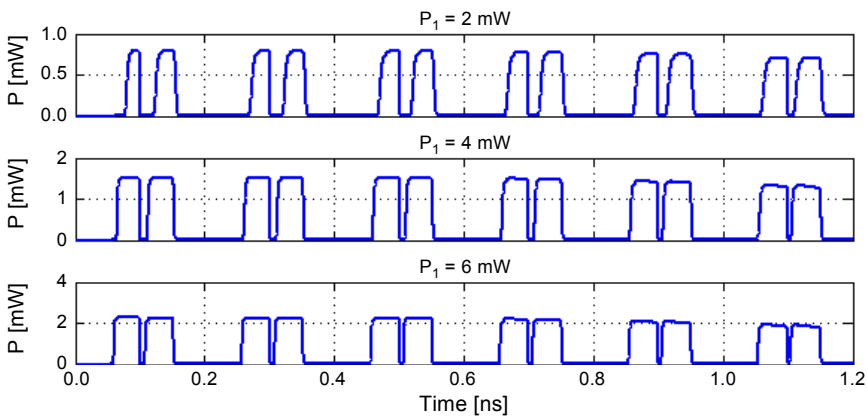

Fig. 9. All optical XOR logic output result for different probe power.

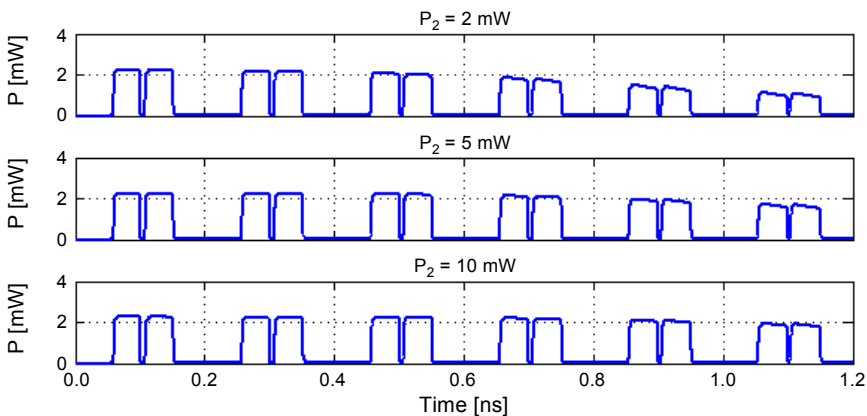

Fig. 10. All optical XOR logic output result for different pump power.

effect becomes more obvious, and the extinction ratio of the output signal is better. Then the signal \bar{A} and \bar{B} with the optimal extinction ratio characteristics are used as pumps to modulate LOA3 and LOA4, respectively, and it apparently improves the final output.

5. Summary

A theoretical model of all-optical logic XOR gate and the logic operation were successfully designed based on cross-gain modulation (XGM) of a linear optical amplifier (LOA). Four LOAs were divided into two group of cascade in the Simulink model and used to obtain better simulated output results. We found that when choosing the probe wavelength between 1520–1540 nm and pump wavelength is bigger than 1560 nm, as well as appropriately increasing the input signal power, such as when the pump power (A and B) is 10 mW, probe power (CW) is 6 mW, the final output results can be improved. Because the Simulink modular structure is easy to modify and expand, the LOA-XGM effect can also be used in a variety of logic gate operations. So our paper has an important guiding significance on all-optical signal processing in optical communication.

Acknowledgements – This work was supported by the grant No. 111102005b from the Guidance of Development project of the Tangshan Science and Technology Foundation.

References

- [1] FRANCIS D.A., DIJAILI S.P., WALKER J.D., *A single-chip linear optical amplifier*, [In] *Optical Fiber Communication Conference and Exhibit, OFC 2001*, Vol. 4, article PD13.
- [2] MINGSHAN ZHAO, DE MERLIER J., MORTIER G., BAETS R., *All-optical 2R regeneration based on polarization rotation in a linear optical amplifier*, *IEEE Photonics Technology Letters* **15**(2), 2003, pp. 305–307.
- [3] TANGDIONGGA E., TURKIEWICZ J.P., KHOE G.D., DE WAARDT H., *Clock recovery by a fiber ring laser employing a linear optical amplifier*, *IEEE Photonics Technology Letters* **16**(2), 2004, pp. 611–613.
- [4] CRIJNS J.J.J., SPIEKMAN L.H., VAN DEN HOVEN G.N., TANGDIONGGA E., DE WAARDT H., *Static and dynamic switching performance of a metro WDM ring using linear optical amplifiers*, *IEEE Photonics Technology Letters* **14**(10), 2002, pp. 1481–1483.
- [5] QURESHI K.K., TAM H.Y., CHUNG W.H., WAI P.K.A., *Multiwavelength laser source using linear optical amplifier*, *IEEE Photonics Technology Letters* **17**(8), 2005, pp. 1611–1613.
- [6] KU-IK CHUNG, TAE-YOUNG KIM, SANG-KOOK HAN, *Analysis of all optical cascaded XGM wavelength converter using CW-holding beam*, *Optical and Quantum Electronics* **34**(10), 2002, pp. 937–950.
- [7] CHAO-YUAN JIN, YONG-ZHEN HUANG, LI-JUAN YU, SHENG-LING DENG, *Numerical and theoretical analysis of the crosstalk in linear optical amplifiers*, *IEEE Journal of Quantum Electronics* **41**(5), 2005, pp. 636–641.
- [8] OKSANEN J., TULKKI J., *On crosstalk and noise in an optical amplifier with gain clamping by vertical laser field*, *Journal of Lightwave Technology* **21**(9), 2003, pp. 1914–1919.

- [9] YABIN YE, XIAOPING ZHENG, HANYI ZHANG, YANHE LI, YILI GUO, *Study on the dynamic range of input power for wavelength converter based on cross-phase modulation in SOAs*, Optics Communications **200**(1–6), 2001, pp. 349–354.
- [10] LI HAI-TAO, PAN WEI, LUO BIN, *et al.*, *Analysis of extinction ratio characteristics of wavelength conversion based on cross-gain modulation in LOA*, Acta Photonica Sinica **36**(10), 2007, pp. 1799–1803, (in Chinese).

*Received April 6, 2015
in revised form June 23, 2015*