

*Paweł Ciężkowski**, *Sebastian Bąk**, *Jarosław Kuśmierczyk**

LOAD DISTRIBUTION OF A FIXED JAW FOR SANDSTONE “MUCHARZ” CRUSHING***

1. Introduction

Crushing machines encounter considerable difficulties concerning external loads acting on their mechanical joints. Attempts to solve these issues based on theoretical calculations don't always provide satisfactory results. Experimental studies can contribute to solving these problems, as well as verifying various theoretical methods. Problems associated with the crushing process have meant that up until now, in the design stages, much more attention has been given to the configuration of the chamber of the rock crusher [4, 5, 12]. When attention is given to the design of the feed opening, (and in particular the chamber height) the efficiency of the machine increases while its size reduces. It should also be noted that an important aspect to be considered in the design of the crusher, is choosing the right kinematic system. In order to get the best performance and product quality, (depending on the material being crushed) the correct machine parameters, such as: nip angle, moving jaw stroke, angular velocity and power also need to be selected. Profiled crushing plates have therefore been developed in order to optimize crusher's performance and operating costs. So far experiments show that crushing plate profiles have an influence on crushing parameters (energy consumption, crushing forces, performance, product shape) [1, 5, 7, 11].

Although experimental studies on machine crushing processes are justified and purposeful, due to the technical difficulties and expense, they are conducted rarely and with limited range. Further progress in crushing technology sets increasingly higher requirements for producing and operating machines. Advances are impossible without detailed information regarding the mechanics of processes, based on solid fundamentals as well as theoretical and experimental knowledge. This paper includes the scientific aspects of crushing as well as various associated issues. This research focusses on the influence of the jaw crushers profile on chamber load distribution.

* Warsaw University of Technology

2. The objective of the work

The experimental tests described in this paper relate to the analysis of loads in the crusher's chamber. Normal and tangential (V and H accordingly) (Fig. 1d) forces at the surface of each fixed plate segment were measured. The crusher's construction provides a fairly accurate determination of the distribution and values of crushing forces for each cycle. The fixed crushing plate 1 (Fig. 1) is divided into nine independent segments, which can be flat (flat jaw plate) or corrugated (corrugated jaw plate). Each segment is properly supported on nine specially constructed strain gauges designed and developed at the Institute of Construction Machinery Engineering at WUT according to data acquired [10].

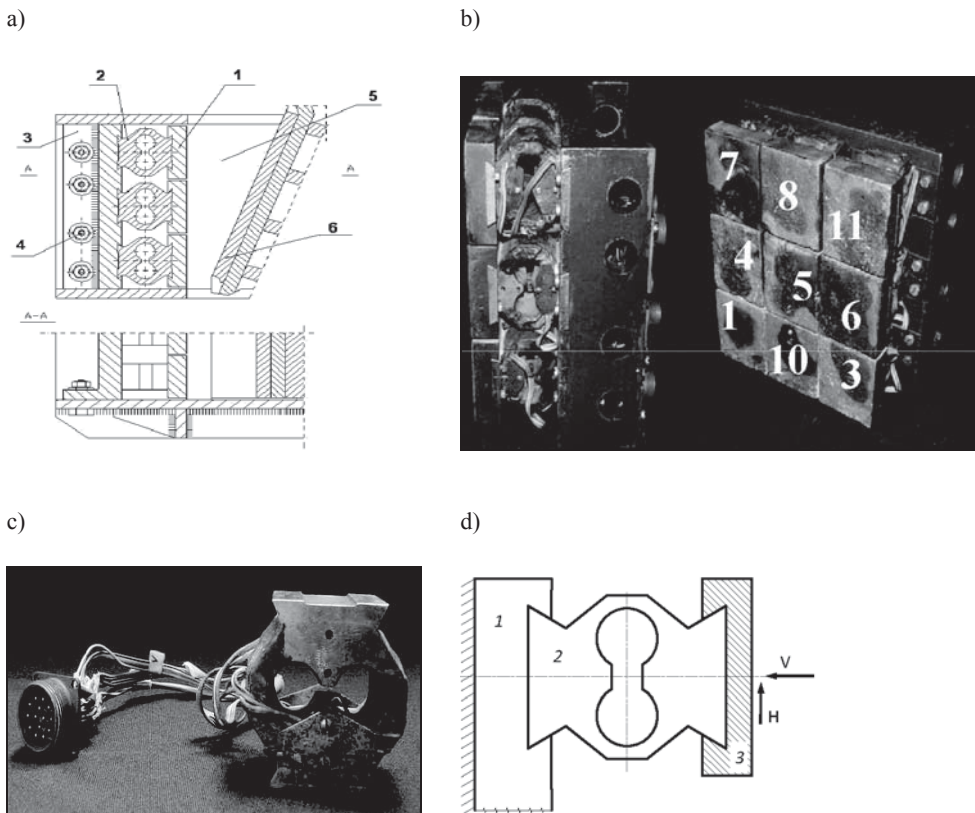

Fig. 1. Force measurement in the crusher working space:

- a) fixed plate construction: 1 — grinding plate segments, 2 — specially designed encoders, 3 — fixed jaw support element, 4 — measuring system for the body connecting bolts, 5 — crushing space, 6 — moving jaw, b) fixed plate — mounted segments,
- c) measurement sensor, d) scheme of sensor loads: 1 — fixed jaw support element, 2 — power measure dynamometer, 3 — crushing plate (one of the nine segments shown in Fig. 1b)

The research was carried out using five sets of crushing plates. The first set uses two flat plates. In the case of the second and third — ribbed plates with parallel teeth were used (Fig. 2b and 2c). In the second set the notches on the plates were aligned while the notches of the third were off-set by a predetermined distance. In the next two cases, plates with a variable t scale were used. In the fourth configuration, aligned teeth were considered and again in the fifth — offset.

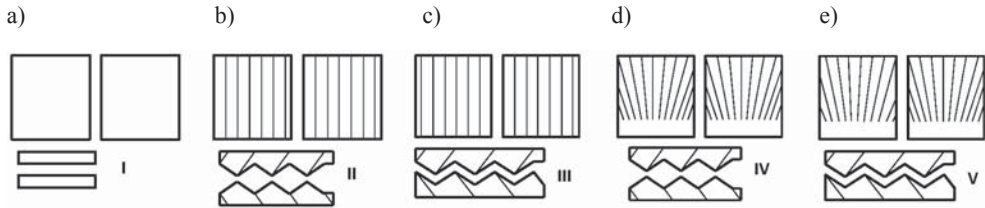

Fig. 2. Crushing plates used in laboratory tests

The material used in the tests was an indigenous rock (sandstone) taken from the Mucharz area with the following strength parameters: uniaxial compressive strength $S_c = 123$ MPa, uniaxial tensile strength $S_t = 11$ MPa, internal friction angle $\rho = 34^\circ$, coherence $c = 31.82$ MPa.

Feed grains were chosen in such a way as to be similar in size and shape to regular grains (according to PN-78/B06714 sheet 16 [6]). A single serving of aggregate with a weight of about 3.9 kg and the average size of $D_{sr} = 80$ mm was poured into the crusher chamber. For each set of plates 7–10 tests were conducted. The crushing process was performed by maintaining constant parameters: the outlet slot $e_r = 24$ mm (Fig. 3, $e_r = s + e_2$), material, rotational speed.

3. Experiments

Determining the influence of the jaw plate shape on load distribution along the height of the chamber forms the basis for the calculation method.

According to the literature data [3, 8–10], calculations of linear (segment $a-b$) or non-linear (segment a_1-b_1) moving jaw load distribution are recommended, as shown in Figure 3. There is no detailed information regarding criteria that should be taken into consideration when choosing load distribution model. In jaw crushers calculations as well as the analysis of their dynamics, it's important to know the point at which the application of the resultant force Z acting on the moving jaw can be found. In the case of the linear distribution of resultant force (force Z) it is assumed as being at the point distant from the outlet slot of $2/3$ chamber height h ($x'_z = 2h/3$).

If non-linear load is applied the H. Sommer formula is used [9].

In double toggle jaw crusher jaws are subjected to a cyclic, concentrated, non-uniform loading. The distribution and value depends on crushing material strength properties, jaws shape and feed grain diameter.

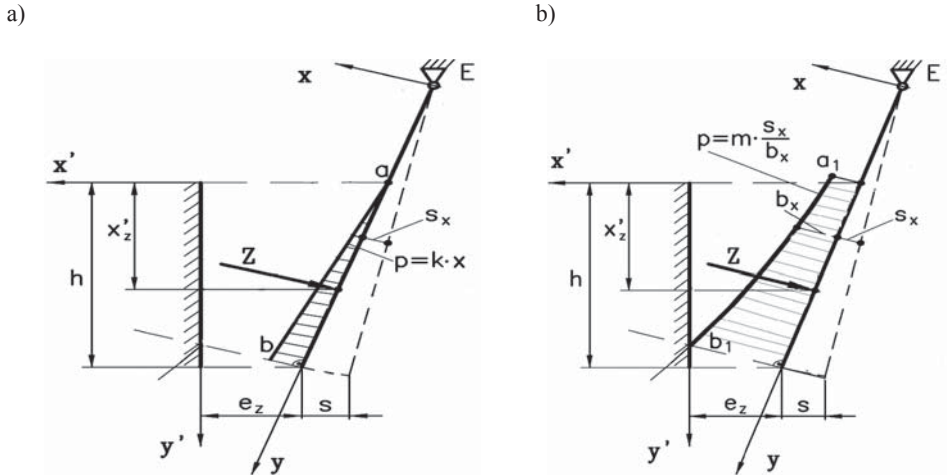

Fig. 3. Load diagram recommended for calculations a) linear $p = kx$, b) non-linear $p = mS_x/b_x^3$, m - constant of proportionality [3, 8–10]

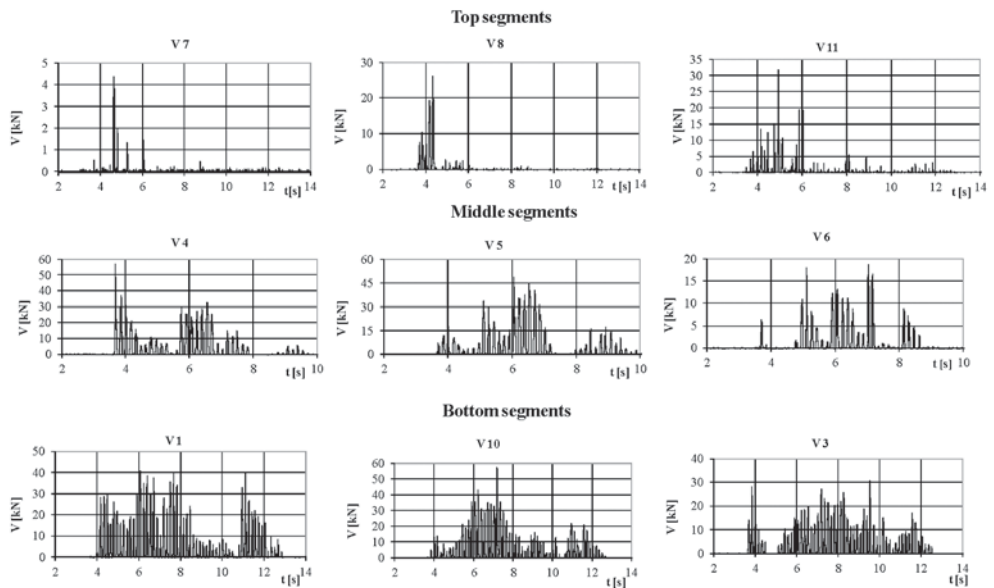

Fig. 4. Sample graphs of normal force changes V ($V1$, $V2$, $V3$, etc.), acting on each segment of fixed crushing plate (first series of tests)

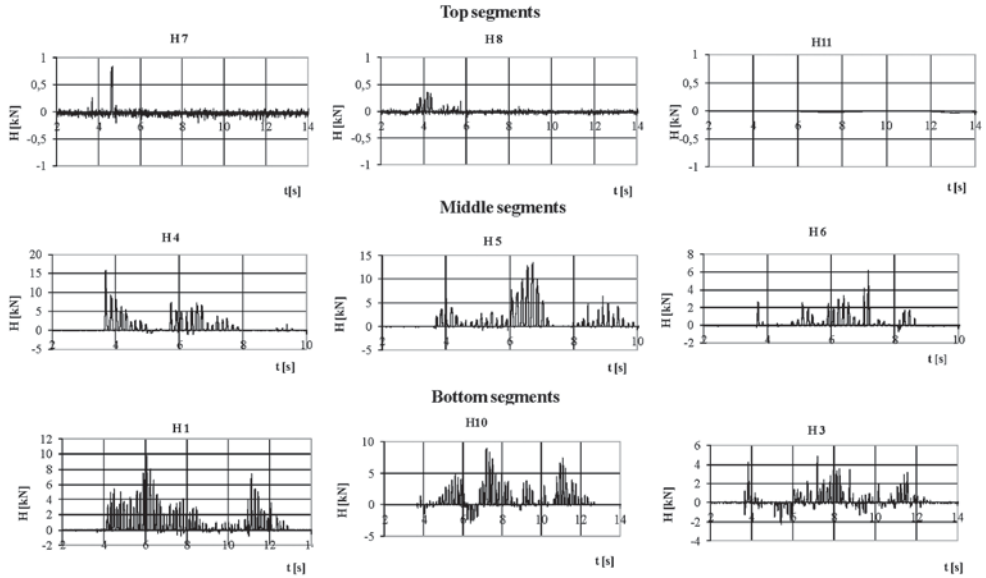

Fig. 5. Sample graphs of tangential force changes H ($H1$, $H2$, $H3$, etc.), acting on each segment of fixed crushing plate (first series of tests)

Laboratory crusher design enables the precise determination of forces acting on crushing chamber plates (Fig. 1d). Forces acting on fixed jaw plate are measured separately to normal (V) and tangential forces (H). Exemplary graphs are shown below (Fig. 4 and 5). With the forces acting on fixed jaw plate known, forces acting on moving jaw plate can be calculated.

Analysis of measured forces taking place during the crushing process show a random character in each cycle as it is clearly shown in Figure 4 and 5.

4. Experimental results description method

In order to compare the effects of the load on each plate, a group of force indexes was introduced (Fig. 6). These are: average temporary value and average value of the maximum forces in a given crushing cycle. As an example consider the method of determining the average value of the normal forces V acting on the strain gauge (Fig. 6).

The average value of the maximum crushing forces $V_{\max \text{ sr}}$ is given by:

$$V_{\max \text{ sr}} = \frac{1}{k} \cdot \sum_{i=1}^k V_{\max i} \quad (1)$$

where:

$V_{\max i}$ — maximum values $V_{\max 1}, V_{\max 2}, \dots, V_{\max k}$,
 k — number of maximum values.

This is the average value of maximum forces recorded in a single test.

The mean value of momentary forces V_{sr} is determined as a calculated average of recorded values from one crushing test, as described below:

$$V_{sr} = \frac{1}{p} \cdot \sum_{i=1}^p V_i \quad (2)$$

where:

V_i — the momentary value of normal forces in the segment,
 p — the number of normal forces registered in the test.

Figure 6 demonstrates a cross section of the normal force profile, for force V measured on a strain gauge.

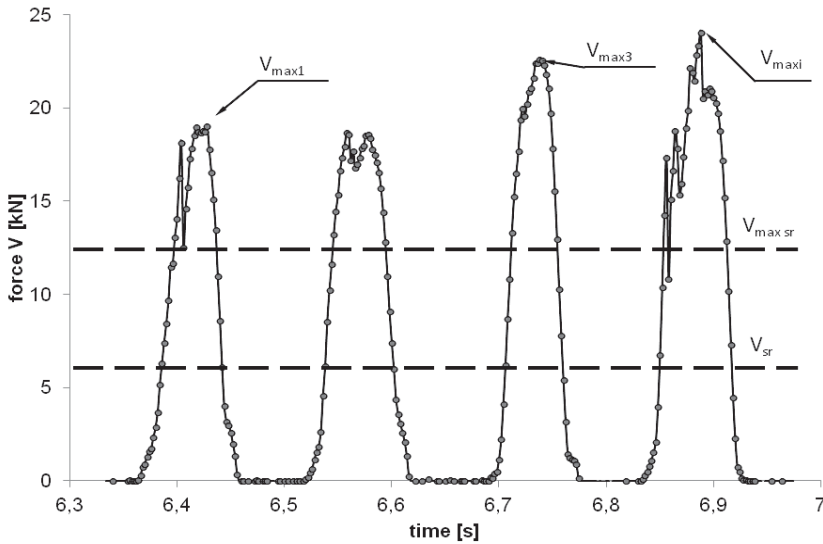

Fig. 6. The determination of normal forces V average values V_{sr} and $V_{\max sr}$ mean values from one test are shown

5. Some results of crushing process analysis

Figure 7a, b shows a sample overview of V_{sr} for a series of tests (10 tests) observed on a flat fixed jaw.

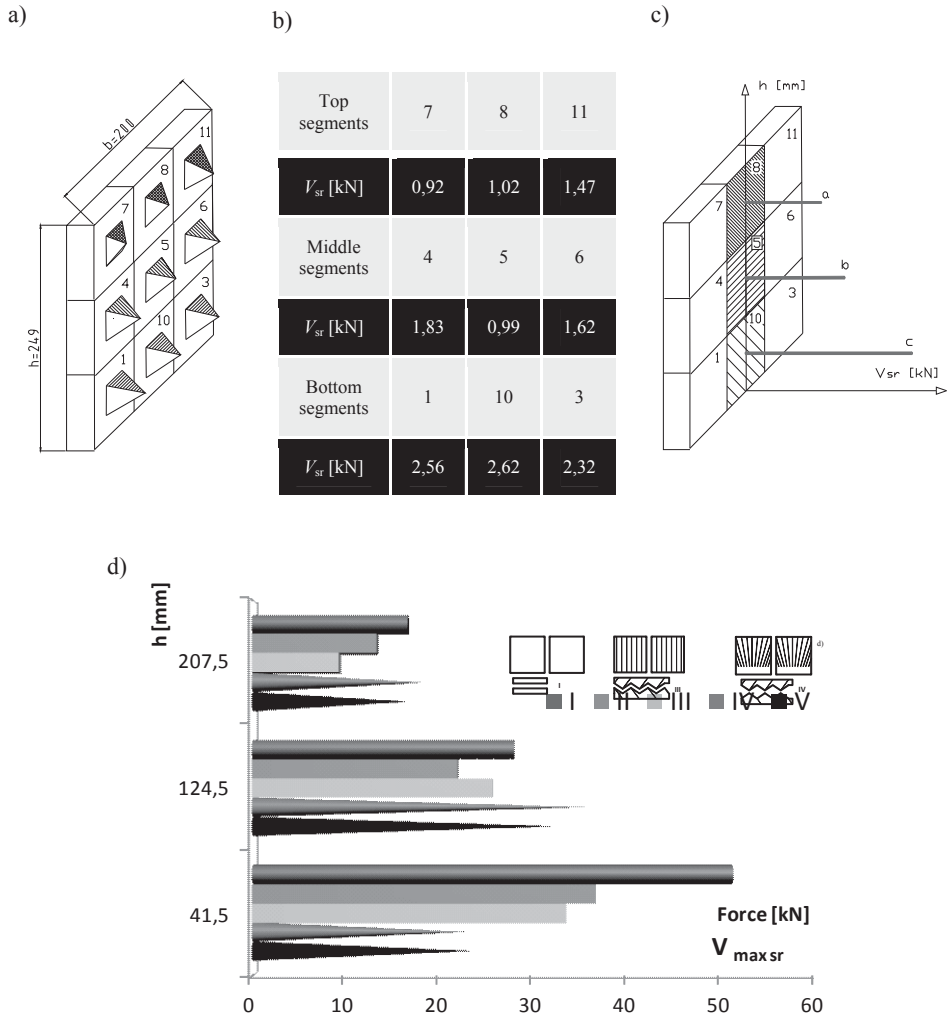

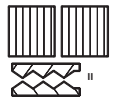
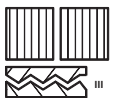
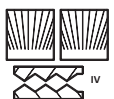



Fig. 7. Crushing process on flat plates:
a, b) values of V_{sr} forces acting on each segment in the series,
c) fixed plate with coordinates, d) mean maximum values of normal $V_{max\ sr}$

In Table 1 the values of mean maximum forces $V_{max\ sr}$, $H_{max\ sr}$ and average forces V_{sr} , H_{sr} from all test series are presented. These are the forces determined for nine fixed jaw segments (Fig. 7) in the selected series and reduced to three sections: top, middle and bottom as shown in Figure 7c, d. Based on the information in Table 1 it can be concluded that normal and tangential forces of distribution, both in the case of mean values V_{sr} , H_{sr} , and in the case of mean maximum forces $V_{max\ sr}$, $H_{max\ sr}$, tested for three different plates are of a similar profile but differing in values.

TABLE 1

Fixed jaw load V_{sr} , $V_{max sr}$, H_{sr} , $H_{max sr}$

Crushing plates		Horizontal section	V_{sr}	$V_{max sr}$	H_{sr}	$H_{max sr}$
			[kN]			
I		Top (7, 8, 11)	3,41	16,73	0,80	2,97
		Middle (4, 5, 6)	4,44	28,18	3,37	13,73
		Bottom (1, 10, 3)	7,50	51,72	4,34	16,06
II		Top (7, 8, 11)	1,05	13,39	1,33	4,75
		Middle (4, 5, 6)	2,99	22,08	2,41	12,92
		Bottom (1, 10, 3)	6,07	36,93	4,17	13,68
III		Top (7, 8, 11)	1,10	9,33	0,77	3,26
		Middle (4, 5, 6)	3,74	25,89	3,64	13,84
		Bottom (1, 10, 3)	4,93	33,79	4,17	13,09
IV		Top (7, 8, 11)	1,86	18,40	4,53	6,81
		Middle (4, 5, 6)	5,17	36,02	2,42	14,10
		Bottom (1, 10, 3)	2,63	23,01	3,34	11,36
V		Top (7, 8, 11)	1,89	16,75	4,13	5,56
		Middle (4, 5, 6)	3,62	32,86	2,42	12,36
		Bottom (1, 10, 3)	2,43	23,77	3,34	8,46

6. Conclusion

The results established provided a number of relevant pieces of information:

- 1) For flat plate crushers and also crushers with plates which have a constant pitch and notch height, the highest loads were found to be in the bottom section of crushing chamber. Maximum values of these forces were thus obtained for flat plates.
- 2) The usage of profiled plates has a beneficial effect on the reduction of the forces in crusher's power train.
- 3) The results clearly indicate further possibilities for increasing the efficiency of the crushing process through the appropriate design of crushing plates.

REFERENCES

- [1] Cieżkowski P.: Correlation of energy consumption and shape of crushing plates, AGH Journal of Mining and Geoengineering, 36 (2), s. 91–100, 2012.
- [2] Cieżkowski P.: Doświadczalne badania sił kruszenia szczękami o różnym kształcie, Zeszyty Naukowe Instytutu Pojazdów, zeszyt 2/88, s. 21–34, 2012.

- [3] *Bauman W.A.*: Opriedielenije osnovnyh paramietrow szczekowych drobilok, Stroitielnyje i Dorożnyje Masziny. 1967, 2, 63–80.
- [4] *Gawenda T.*: Problematyka doboru maszyn kruszących w instalacjach produkcji kruszyw mineralnych Górnictwo i Geoinżynieria ISSN 1732-6702, 2010 R. 34, z. 4, s. 195–209.
- [5] *Kobialka R., Naziemiec Z.*: Badania procesu kruszenia szczękami o różnym profilu poprzecznym, Górnictwo i Geoinżynieria, Nr 30, zeszyt 3/1, 2006.
- [6] PN-78/B06714 arkusz 16. Kruszywa mineralne. Badania. Oznaczenia kształtu ziarn.
- [7] *Rumpf H.*: Struktur der Zerkleinerungswissenschaft. Aufbereitungs-Technik. 1966, 8, 421–435.
- [7] *Sobolewski S.*: Kruszarki, budowa i zastosowanie. Katowice „Śląsk”, 1957.
- [8] *Sommer H.*: Beitrag zur Berechnung von Brechern und Kreiselbrechern. Aufbereitungs-Technik 11, 1960.
- [9] *Zawada J. (red)*: Wprowadzenie do mechaniki maszynowych procesów kruszenia (na przykładzie kruszarek szczękowych). Radom, Wydawnictwo Instytutu Technologii Eksploatacji, 2005.
- [10] *Zawada J., Chochół K.*: Doświadczalne badania energii kruszenia (na przykładzie modelowej kruszarki dźwigniowej Blake’a). Górnictwo i Geoinżynieria 33/4 (2009), s. 317–326, ISSN: 1732-6702.
- [11] *Zawada J., Pawlak W.*: Einfluß der Oberflächenform von brechplatten für backenbrecher auf das Zerkleinerungsergebnis. Aufbereitungs-Technik, 1988. Nr 3.